

easYgen-800

Manual | Genset Control



easYgen-800

37691A

This is no translation but the original Technical Manual in English.
Designed in Germany and Poland; manufactured in China.

Woodward GmbH

Handwerkstrasse 29

70565 Stuttgart

Germany

Telephone: +49 (0) 711 789 54-510

Fax: +49 (0) 711 789 54-101

E-mail: stgt-info@woodward.com

Internet: <http://www.woodward.com>

Brief Overview

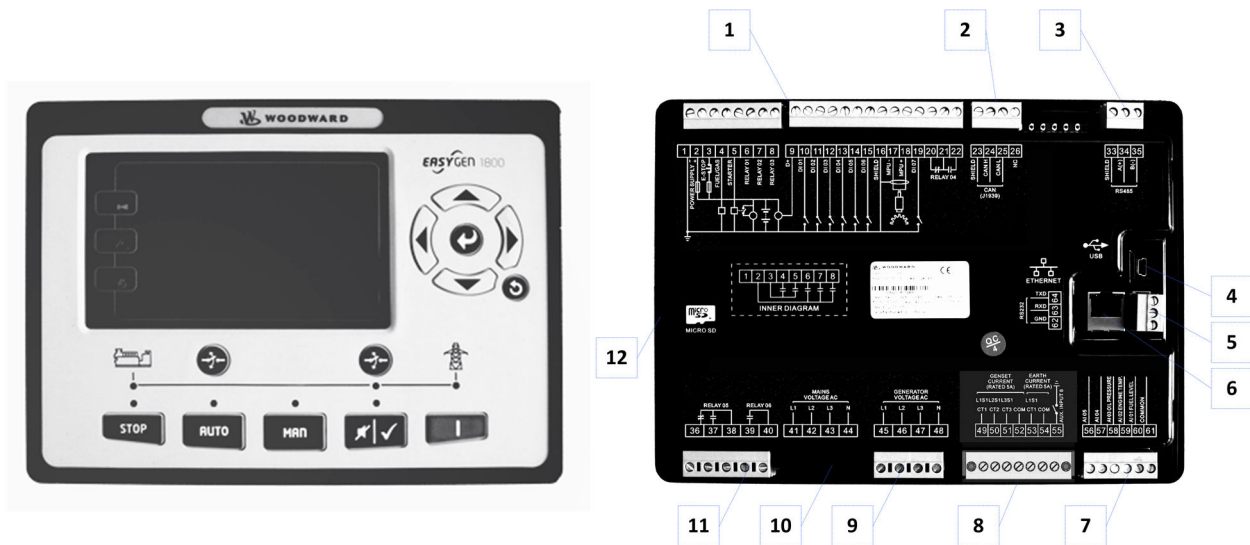

Fig. 1: easYgen-800

- | | |
|--|--|
| <ul style="list-style-type: none"> 1 Terminals 1 to 22: Power supply, relays, discrete inputs, MPU, D+, ... 2 Terminals 23 to 26: CAN (J1939) 3 Terminals 33 to 35: RS-485 interface 4 USB service port for PC/laptop with ToolKit-SC 5 Terminals 62 to 64: RS-232 interface 6 ETHERNET interface connector (RJ-45) 7 Terminals 56 to 61: Analog inputs | <ul style="list-style-type: none"> 8 Terminals 49 to 55 (screwable): Generator and Ground current 9 Terminals 45 to 48: Generator voltage 10 Terminals 41 to 44: Intentionally not implemented 11 Terminals 36 to 40: Relay outputs 12 SD micro card slot |
|--|--|

The easYgen-800 are control units for engine-generator system management applications.

The control units can be used in applications such as: co-generation, stand-by, AMF or distributed generation.

Scope of delivery

The following parts are included in the covering box. Please check prior to the installation that all parts are present:

- Device easYgen genset control
All screwable terminal connectors are delivered with plug **and** jack
- Clamp fastener installation material (4x)
- "Installation Procedure Supplement" paper with links to the latest edition of Technical Documentation and software for download:
(<http://www.wwdmanuals.com/easYgen-800>)



Configuration software and Technical Manual are available at Woodward web site:
<http://www.woodward.com/easYgen-800.aspx>

Sample application setup

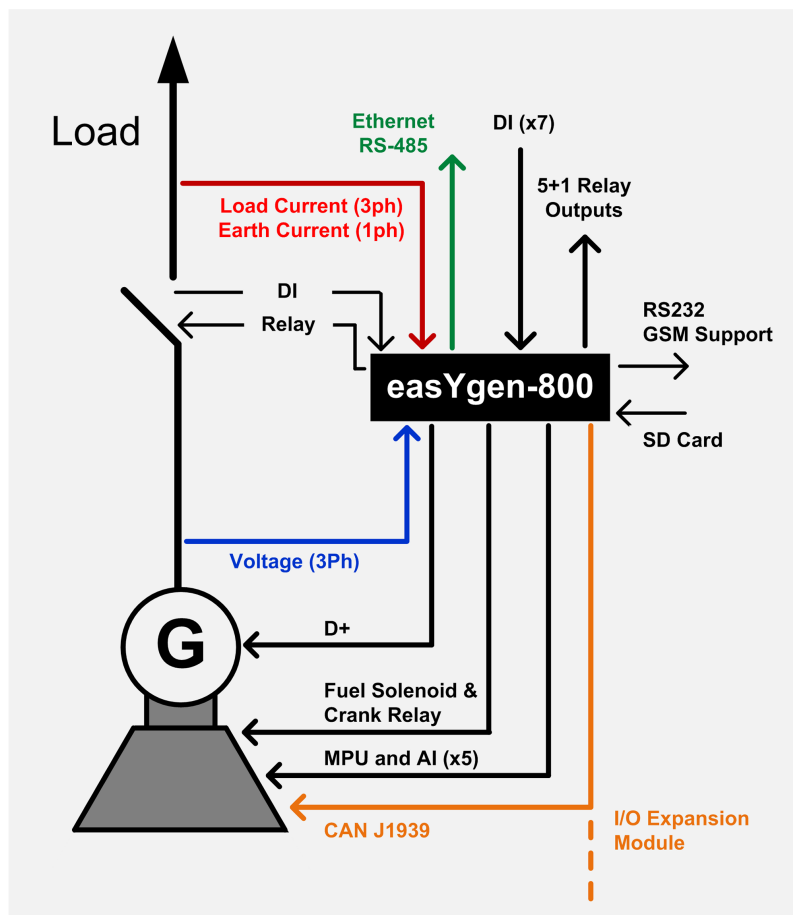

Fig. 2: Sample application setup

A typical application mode for the control unit is the use for non parallel operation in a single genset application.

- In this case, the easYgen will function as an engine control with generator and engine protection.
- The control unit can open and close the circuit breaker .



Transition procedures are described in chapter
 ↪ Chapter 5.5 "Transition Procedures"
 on page 99.

Table of contents

1	General Information	9
1.1	About This Manual.....	9
1.1.1	Revision History.....	9
1.1.2	Depiction Of Notes And Instructions.....	9
1.2	General Information.....	10
1.2.1	Copyright And Disclaimer.....	10
1.2.2	Service And Warranty.....	11
1.2.3	Safety.....	11
1.2.3.1	Intended Use.....	11
1.2.3.2	Personnel.....	12
1.2.3.3	General Safety Notes.....	13
2	System Overview	15
2.1	Display and Status Indicators.....	15
2.2	Operation Modes.....	16
2.2.1	Operation Mode AUTO.....	16
2.2.2	Operation Mode MANual.....	16
2.2.3	Operation Mode STOP.....	17
2.3	Features and Functions of both easYgen-800 and -1800.....	17
2.4	Functions.....	19
2.5	Intended Use of This Control.....	20
3	Installation	21
3.1	Mounting.....	21
3.2	Wiring.....	21
3.3	Interfaces.....	26
3.3.1	Ethernet Interface Connection.....	26
3.4	Micro SD Card Slot.....	27
3.5	Install ToolKit-SC.....	28
4	Configuration	29
4.1	Access to the Control.....	30
4.1.1	Access Via The Front Panel.....	30
4.1.1.1	Front Panel: Operating and Display Elements.....	30
4.1.1.2	Front Panel Control.....	32
4.1.2	Configure ToolKit-SC.....	35
4.1.2.1	Configure Communication.....	35
4.1.2.2	Manage Configuration Data.....	35
4.1.2.3	Configure Customized Language.....	36
4.1.3	Access via ToolKit-SC Configuration Tool.....	37

Table of contents

4.1.3.1	Read/Write Configuration.....	38
4.2	Parameters.....	38
4.2.1	Parameter Menu Structure.....	38
4.2.2	Parameter Settings Menu--HMI Access.....	40
4.2.3	Configure Measurement.....	41
4.2.4	Configure Application.....	42
4.2.4.1	Configure Inputs and Outputs.....	42
4.2.4.2	Configure Engine.....	51
4.2.4.3	Configure TEST Run.....	52
4.2.4.4	Configure Breakers.....	53
4.2.5	Configure Monitoring.....	54
4.2.5.1	Monitoring Generator	54
4.2.5.2	Monitoring Breakers.....	57
4.2.5.3	Monitoring Engine.....	57
4.2.5.4	Other Monitoring.....	59
4.2.6	Configure Interfaces.....	59
4.2.6.1	Configure GSM Module.....	60
4.2.6.2	Configure Ethernet Interface.....	62
4.2.7	Configure Maintenance.....	63
4.2.8	Configure Counters.....	65
4.2.9	Configure Switchable Parameter Set.....	66
4.2.10	Configure Language / Clock.....	66
4.2.11	Configure System Management.....	67
4.2.12	Configure HMI.....	67
4.3	Selectable Inputs/Outputs/Sensors.....	69
4.3.1	Programmable Sensors.....	69
4.3.2	Programmable Inputs.....	70
4.3.3	Programmable Outputs.....	72
4.4	Status Menu.....	76
4.4.1	HMI Status Screens.....	76
4.4.2	ToolKit-SC Status Screens.....	77
4.4.3	Configure For Using Accessories.....	79
4.4.3.1	Digital Input Module WWDIN16.....	80
4.4.3.2	Digital Output Module WWDOUT16.....	87
5	Operation.....	91
5.1	Front Panel: Operating and Display Elements.....	91
5.2	Warning/Alarm Signaling.....	93
5.2.1	Alarm Acknowledgment.....	93
5.3	Operation Modes.....	94
5.3.1	Operation Mode AUTO.....	94
5.3.2	Operation Mode MANual.....	94

5.3.3	Operation Mode STOP.....	94
5.4	START/STOP Operation.....	95
5.4.1	Start engine to supply load.....	95
5.4.2	Stop engine.....	96
5.4.3	MANual START/STOP.....	99
5.5	Transition Procedures.....	99
5.5.1	Disconnect during Cranking.....	99
5.6	Trouble Shooting.....	100
6	Application.....	101
6.1	Commissioning.....	101
7	Interfaces and Protocols.....	103
7.1	J1939.....	103
8	Technical Specifications.....	109
8.1	Measuring and Monitoring.....	111
9	Appendix.....	113
9.1	Alarms and Warnings.....	113
9.1.1	Alarm Classes.....	113
9.1.2	Warnings.....	113
9.1.3	Shutdown Alarms.....	114
9.1.4	Trip and Stop Alarms.....	116
9.1.5	Trip Alarms.....	116
9.2	Trouble Shooting.....	117
9.3	Data Telegrams.....	117
9.3.1	Modbus Basics.....	117
9.3.1.1	Data Frame Format.....	118
9.3.1.2	Modbus Communication Protocol.....	118
9.3.1.3	Information Frame Format.....	118
9.3.1.4	Address Code.....	119
9.3.1.5	Function Code.....	119
9.3.1.6	Data Field.....	120
9.3.1.7	Error Check Code (CRC).....	120
9.3.1.8	Error Handling.....	124
9.3.2	Read Holding Registers 03_hex.....	125
9.3.3	Force Single Coil 05H_hex.....	147
9.3.4	Preset Single Register 06H_hex.....	148
9.3.4.1	Generator Status.....	148
9.3.4.2	Remote Start Status.....	148
9.3.4.3	Breaker Status.....	149

Table of contents

10	Glossary And List Of Abbreviations.....	151
11	Index.....	153

1 General Information

1.1 About This Manual

1.1.1 Revision History

Rev.	Date	Editor	Changes
NEW	2018-03	GG	<p>Describes device implemented software version 2.x and ToolKit-SC version 1.1.x.x</p> <p>Technical Manual</p> <ul style="list-style-type: none"> ■ Release = 1st issue

1.1.2 Depiction Of Notes And Instructions

Safety instructions

Safety instructions are marked with symbols in these instructions. The safety instructions are always introduced by signal words that express the extent of the danger.



DANGER!

This combination of symbol and signal word indicates an immediately-dangerous situation that could cause death or severe injuries if not avoided.



WARNING!

This combination of symbol and signal word indicates a possibly-dangerous situation that could cause death or severe injuries if it is not avoided.



CAUTION!

This combination of symbol and signal word indicates a possibly-dangerous situation that could cause slight injuries if it is not avoided.



NOTICE!

This combination of symbol and signal word indicates a possibly-dangerous situation that could cause property and environmental damage if it is not avoided.







Tips and recommendations



This symbol indicates useful tips and recommendations as well as information for efficient and trouble-free operation.

Additional markings

To emphasize instructions, results, lists, references, and other elements, the following markings are used in these instructions:

Marking	Explanation
	Step-by-step instructions
	Results of action steps
	References to sections of these instructions and to other relevant documents
	Listing without fixed sequence
[Buttons]	Operating elements (e.g. buttons, switches), display elements (e.g. signal lamps)
"Display"	Screen elements (e.g. buttons, programming of function keys)
"Screen xx → Screen xy → Screen xz" ...	Menu path. The following information and setting refer to a page on HMI screen or ToolKit located as described here.
 	Some parameters/settings/screens are available only either in ToolKit or in HMI/display.



Dimensions in Figures

All dimensions shown with no units specified are in mm.

1.2 General Information

1.2.1 Copyright And Disclaimer

Disclaimer

All information and instructions in this manual have been provided under due consideration of applicable guidelines and regulations, the current and known state of the art, as well as our many years of in-house experience. Woodward assumes no liability for damages due to:

- Failure to comply with the instructions in this manual
- Improper use / misuse
- Willful operation by non-authorized persons
- Unauthorized conversions or non-approved technical modifications
- Use of non-approved spare parts

The originator is solely liable to the full extent for damages caused by such conduct. The agreed upon obligations in the delivery contract, the general terms and conditions, the manufacturer's delivery conditions, and the statutory regulations valid at the time the contract was concluded, apply.

Copyright

This manual is protected by copyright. No part of this manual may be reproduced in any form or incorporated into any information retrieval system without written permission of Woodward GmbH.

Delivery of this manual to third parties, duplication in any form - including excerpts - as well as exploitation and/or communication of the content, are not permitted without a written declaration of release by Woodward GmbH.

Actions to the contrary will entitle us to claim compensation for damages. We expressly reserve the right to raise any further accessory claims.

1.2.2 Service And Warranty

By opening the device you will lose any warranty!



CAUTION!

Any unauthorized modifications or using this equipment outside its specified mechanical, electrical, or other operating limits may cause personal injury and/or property damage, including damage to the equipment.

Any such unauthorized modifications

- constitute "misuse" and/or "negligence" within the meaning of the product warranty
- thereby excluding warranty coverage for any resulting damage, and
- invalidate product certifications or listings.

Our Customer Service is available for technical information. Please see page 2 for the contact data.

In addition, our employees are constantly interested in new information and experiences that arise from usage and could be valuable for the improvement of our products.

Warranty terms



Please enquire about the terms of warranty from your nearest Woodward representative.

*For our contact search webpage please go to:
<http://www.woodward.com/Directory.aspx>*

1.2.3 Safety

1.2.3.1 Intended Use

The easYgen unit has been designed and constructed solely for the intended use described in this manual.

The easYgen unit has been designed and constructed solely for the intended use described in this Operation Manual and--with even more details-- in the Technical Manual.

- Intended use requires operation of the control unit within the specifications listed in ↗ *Chapter 8 "Technical Specifications" on page 109.*
- Intended use requires operation of the control unit within the written specifications.
- All permissible applications are outlined in ↗ *Chapter 6 "Application" on page 101.*
- Intended use includes compliance with all instructions and safety notes presented in this manual.

General Information

General Information > Safety > Personnel

- Any use which exceeds or differs from the intended use shall be considered improper use.
- No claims of any kind for damage will be entertained if such claims result from improper use.



NOTICE!

Damage due to improper use!

Improper use of the remote panel unit may cause damage to the control unit as well as connected components.

Improper use includes, but is not limited to:

- Operation outside the specified operation conditions.

1.2.3.2 Personnel



WARNING!

Hazards due to insufficiently qualified personnel!

If unqualified personnel perform work on or with the control unit hazards may arise which can cause serious injury and substantial damage to property.

- Therefore, all work must only be carried out by appropriately qualified personnel.

This manual specifies the personnel qualifications required for the different areas of work, listed below:

- Well trained for electrical installations.
- Skilled and competent to be aware especially of the local safety regulations.
- Experienced in working on electronic measuring and control devices.
- Allowed to manage the controlled (engine/generator) system.

The workforce must only consist of persons who can be expected to carry out their work reliably. Persons with impaired reactions due to, for example, the consumption of drugs, alcohol, or medication are prohibited.

When selecting personnel, the age-related and occupation-related regulations governing the usage location must be observed.

1.2.3.3 General Safety Notes

Hazards by system controlled

**DANGER!****Moving parts and dangerous electricity!**

Be aware that the remote control of a system that is managing life dangerous engine-generator-electricity parts needs attention for the local situation!

The following safety notes cover both the device itself and basics of the overall genset system. The dedicated genset-system related safety instruction must be taken into account, too!

Prime mover safety

**WARNING!****Hazards due to insufficient prime mover protection**

The engine, turbine, or other type of prime mover should be equipped with an overspeed (over-temperature, or over-pressure, where applicable) shut-down device(s), that operates totally independently of the prime mover control device(s) to protect against runaway or damage to the engine, turbine, or other type of prime mover with possible personal injury or loss of life should the mechanical-hydraulic governor(s) or electric control(s), the actuator(s), fuel control(s), the driving mechanism(s), the linkage(s), or the controlled device(s) fail.

General Information

General Information > Safety > General Safety Notes

2 System Overview

General notes

The easYgen is a stand-alone genset controller with measuring, monitoring, and breaker control functionality. It comes with a easy mounting plastic housing covering a well tested electronic-electrical system.

Display and buttons of the HMI offer both access to states and values, and access to the application. Password protection enables dedicated operation access levels. Remote control, monitoring, visualization, and configuration are possible via integrated interfaces. Communication between easYgens, with PLC control, or as a network member offers an enhanced system management range; additionally supported by easy to implement accessories.



For even higher challenges in genset control the easYgen series offers further solutions up to the most complex and ambitious applications.

For dedicated protection tasks ask Woodward for its protection (relay) solutions.

2.1 Display and Status Indicators

General Notes

HMI and the configuration software enable access to control, settings, and visualization. The front panel offers a number of functional defined buttons and a set of menu management buttons. LEDs visualize fixed states, the graphic display works together with the menu management buttons to show all necessary information.



Restrictions

Full access to all parameters and settings with configuration software only!

HMI access offers a number of information screens in general, and enables - password protected - access to parameters and settings.



Fig. 3: easYgen-800

2.2 Operation Modes

General notes

The easYgen offers three operation modes:

- AUTO
- MANUAL (MAN)
- STOP
- ... and an internal (non) operating phase during starting the device itself

The operation mode can be initiated - if current settings allow this function:

- directly by pressing the according button at the front panel
- directly by click on the according button at the ToolKit-SC remote screen
- via discrete inputs
- via interface

2.2.1 Operation Mode AUTO

General notes

In operation mode AUTO both genset and breaker are under easYgen control. Start and stop of the engine is managed automatically together with opening/closing the breaker.

Depending on settings and application status, AUTO control can:

- supply load by generator
- start the engine
- stop the engine

2.2.2 Operation Mode MANual

General notes

In operation mode MANual both genset and breakers are independently from each other under easYgen control.

Start and stop of the engine is managed with the same procedure as in AUTO mode but without breaker control. Breakers can be opened and closed without taking care of load or genset state!

2.2.3 Operation Mode STOP

General notes

In operation mode STOP the breaker is open and engine is not running.



This is a configurable operation mode, only. This is NO emergency STOP!

2.3 Features and Functions of both easYgen-800 and -1800

Both easYgen-800 and easYgen-1800 are very close in hardware and software. The easYgen-1800 is the device with more/higher functionality. For comparison and better differentiation both are described below.

easYgen-800 is intended to be used for single automation systems, auto start/stop of the unit are performed with the help of remote signal.

easYgen-1800 has all functions of easYgen-800 as well as automatic mains failure function (AMF), particularly well suited for single automation systems that include mains and generator.

Functional Blocks

Item		easYgen-800	easYgen-1800
LCD (with backlight)	Dimension	4.3"	4.3"
	Pixel	480 x 272	480 x 272
AMF		no	•
Input Port Number		8	8
Output port Number		8	8
Sensor number		5	5
Neutral (earth) current		•	•
Schedule function		•	•
RS485		•	•
Ethernet		•	•
GSM		•	•
J1939		•	•
USB		•	•
Micro SD card (slot)		•	•
Real-time clock		•	•
Event log		•	•

Key characteristics

- With ARM-based 32-bit SCM, highly integrated hardware, high reliability level
- Multilingual interface (including English, Chinese or other customer specific languages) which can be chosen at the site, making commissioning convenient for factory personnel
- Improved LCD wear-resistance and scratch resistance due to hard screen acrylic
- Silicon panel and pushbuttons for better operation in high-temperature environment
- RS-485 communication port enabling remote control, remote measuring, remote communication via ModBus protocol
- SMS (Short Message Service) function: When genset is alarming, controller can send short messages via SMS automatically to max. 5 telephone numbers (external GSM modem is needed). Besides this, generator status can be controlled and checked.
- Equipped with CAN bus port to communicate with J1939 genset. Monitoring frequently-used data such as water temperature, oil pressure, speed, fuel consumption and so on of ECU machine, and additionally also control start, stop, raising speed, and speed droop via CAN bus port
- Suitable for 3-phase 4-wire, 3-phase 3-wire, single phase 2-wire, and 2-phase 3-wire systems with voltage 120/240 V and frequency 50/60 Hz
- **easYgen-1800 only:** Collects and shows 3-phase voltage, current, power parameter and frequency of generator or mains. Mains Generator Line voltage (U_{AB} , U_{BC} , and U_{CA}) Line voltage (U_{AB} , U_{BC} , and U_{CA}) Phase voltage (U_A , U_B , and U_C) Phase voltage (U_A , U_B , and U_C)
- **easYgen-800 only:** Collects and shows 3-phase voltage, current, power parameter and frequency of generator. Generator Line voltage (U_{AB} , U_{BC} , and U_{CA}) Line voltage (U_{AB} , U_{BC} , and U_{CA}) Phase voltage (U_A , U_B , and U_C) Phase voltage (U_A , U_B , and U_C)
- Phase sequence, frequency, Load current I_A , I_B , I_C
- Each phase: Total active power [kW], Total reactive power [kvar], Total apparent power [kVA], Average power factor PF
- Accumulated Total generator power [kWh], [kvarh], [kVAh], and Earth current
- **easYgen-1800 only:** For Mains, controller has over and under voltage, over and under frequency, loss of phase and phase sequence wrong detection functions
- For generator, controller has over and under voltage, over and under frequency, loss of phase, phase sequence wrong, over and reverse power, over current functions
- 3 fixed analog sensors (temperature, oil pressure and fuel level)
- Flexible sensors can be set as temperature sensor, oil pressure sensor or level sensor
- Precision measure and display parameters about Engine, Temp. (WT) °C/°F both be displayed Oil pressure (OP) kPa/psi/bar all be displayed Fuel level (FL) %(unit) Speed (SPD) r/min (unit) Battery Voltage (VB) V (unit) Charger Voltage (VD) V (unit) Hour count (HC) can accumulate to max. 65535 hours. Start times can accumulate to max. 65535 times
- Protection: automatic start/stop of the genset, ATS (Auto Transfer Switch) control with perfect failure indication and protection function
- All output ports are relay-out

- Parameter setting: parameters can be modified and stored in internal FLASH memory and cannot be lost even in case of power outage; most of them can be adjusted using front panel of the controller and all of them can be modified using ToolKit-SC configuration software on PC via USB, Ethernet, or RS485 ports
- More kinds of curves of temperature, oil pressure, fuel level can be used directly and users can define the sensor curves by themselves
- Multiple crank disconnect conditions (generator frequency, speed sensor, oil pressure) are optional
- Widely power supply range DC (8 to 35) V, suitable to different start battery voltage environment
- Event log, real-time clock, scheduled start & stop generator (can be set as start genset once a day/week/month whether with load or not)
- Logon wallpaper and display time are user-defined
- Can be used on pumping units and as an indicating instrument (indicate and alarm are enable only, relay is inhibited)
- With maintenance function. Actions (warning or shutdown) can be set when maintenance time out
- All parameters are digital adjusted (instead of conventional analog modulation with normal potentiometer) for more reliability and stability
- Waterproof security level IP55 due to rubber seal installed between the controller enclosure and front panel
- Metal fixing clips enable perfect in high temperature environment
- Modular design, self-extinguishing ABS plastic enclosure, plug-gable connection terminals and embedded installation way; compact structure with easy mounting
- Accumulation of total run time and total electric energy of A and B. Users can reset it for convenience.

2.4 Functions

- Protection: automatic start/stop of the genset, ATS (Auto Transfer Switch) control with failure indication and protection function
- All output ports are relay-out
- Parameter setting: parameters can be modified and stored in internal FLASH memory and cannot be lost even in case of power outage; most of them can be adjusted using front panel of the controller and all of them can be modified using ToolKit-SC on a PC via USB or RS485 ports.
- Curves of temperature, oil pressure, fuel level can be used directly and users can define the sensor curves by themselves
- Multiple crank disconnect conditions (generator frequency, speed sensor, oil pressure) are optional
- Event log, real-time clock, scheduled start & stop generator (can be set as start genset once a day/week/month whether with load or not)
- Logon wallpaper and display time are user-defined
- Can be used on pumping units and as an indicating instrument (indicate and alarm are enable only, relay is inhibited)
- Maintenance function: Actions (warning or shutdown) can be set when maintenance time out

System Overview

Intended Use of This Control

- All parameters use digital adjustment, instead of conventional analog modulation with normal potentiometer for more reliability and stability
- Accumulative total run time and total electric energy of A and B. User can reset it as 0 and re-accumulative the value which allows to count the total value user defined.

2.5 Intended Use of This Control

easYgen-800 genset controllers are used for

- genset automation and monitor control system of single unit to achieve
- automatic start/stop,
- data measurement,
- alarm protection and
- three remote features: control, measuring and communication.

The controller adopts large liquid crystal display (LCD) and selectable Chinese, English or other languages interface with easy and reliable operation.

This easYgen genset controllers adopt 32 bits micro-processor technology with precision parameters measuring, fixed value adjustment, time setting and threshold adjusting and etc. The majority of parameters can be set using front panel and all the parameters can be set using PC (via USB port) and can be adjusted and monitored with the help of RS-485 port. It can be widely used in a number of automatic genset control system with compact structure, simple connections and high reliability

3 Installation

3.1 Mounting

The controller unit is panel built-in design to be fixed by clips. The controller's overall dimensions and cutout dimensions for panel are: see graphic below.



Use clips included in delivery. Tighten strong but not with brute force to get best IP protection result!

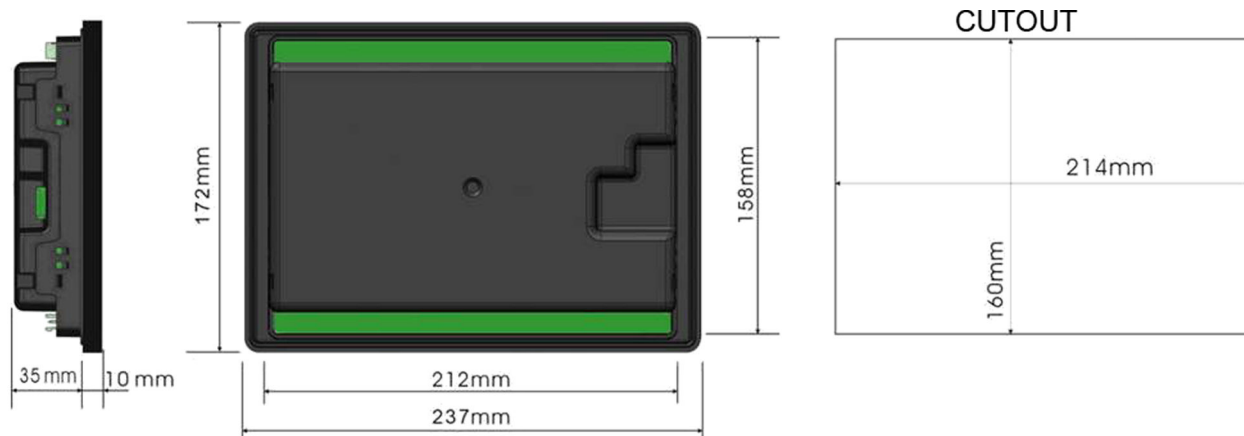

Fig. 4: easYgen-800/1800 cut-out

3.2 Wiring

General Notes



Battery Voltage Input

This controller can be used with a wide range of battery voltage 8 to 35 V_{DC}.

Negative of battery must be connected with the engine shell. The wire between power supply and battery must be bigger than 2.5 mm².

If floating charge is configured: In order to prevent charge disturbing the controller's normal working please ...

- *first connect output wires of charger to battery's positive and negative directly,*
- *then connect wires from battery's positive and negative to controller's positive and negative input ports.*



Speed Sensor Input

Use two cores shielding line wires. Connect the shielding layer to terminal 16 while the other side is not connected.

Connect the two signal wires to terminals 17 and 18. The output voltage of speed sensor should be within 1 to 24 V^{eff}. 12 V^{eff} is recommended for rated speed.



CAUTION!

Digital (Relays) Outputs

To prevent the controller before damage ...

DC current relays: add freewheel diodes at both ends of relay's coils

AC current relays: increase resistance of the relay's coils return circuit



Current input of controller must be connected to the outside of the current transformer (secondary side current is 5 A). Phases of current transformer and input voltage must be correct. Otherwise, the current of collecting power and active power maybe not correct.

I_{COM} port terminal 52 must be connected to negative pole of battery.



WARNING!

If there is a load current, open circuit of transformer's secondary side is not allowed!



CAUTION!

Withstand Voltage Test

Disconnect all terminal connections before high voltage test of the installed controller.

Terminals

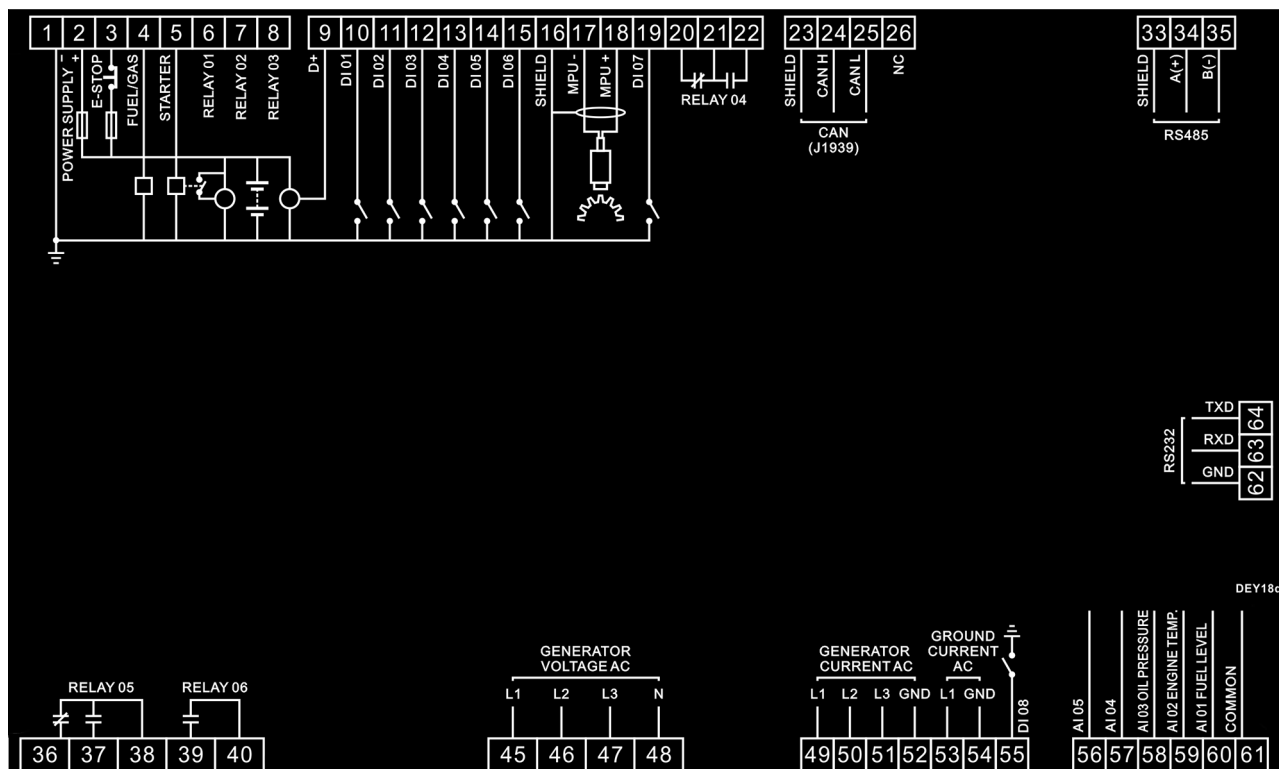

Fig. 5: easYgen-800 Terminals

No.	Function	Cable Size	Remarks	
1	POWER SUPPLY +	2.5 mm ²	Connected with negative of starter battery	
2	POWER SUPPLY -	2.5 mm ²	Connected with positive of starter battery. If wire length is over 30m, better to double wires in parallel. Max. 20A fuse is recommended.	
3	E-STOP	2.5 mm ²	Connected with B+ via emergency stop button	
4	FUEL/GAS	1.5 mm ²	B+ is supplied by 3 terminal, rated 16 A	
5	STARTER	1.5 mm ²	B+ is supplied by 3 terminal, rated 16 A	Connected to starter coil
6	RELAY 01	1.5 mm ²	B+ is supplied by 2 terminal, rated 7 A	Details see Chapter 4.3.3 "Programmable Outputs" on page 72
7	RELAY 02	1.5 mm ²	B+ is supplied by 2 terminal, rated 7 A	
8	RELAY 03	1.5 mm ²	B+ is supplied by 2 terminal, rated 7 A	
9	D+	1.0 mm ²	Connected with charger starter's D+ (WL) terminals. Being hang up If there is no this terminal.	
10	DI 01	1.0 mm ²	Ground connected is active (B-)	Details see Chapter 4.3.2 "Programmable Inputs" on page 70
11	DI 02	1.0 mm ²	Ground connected is active (B-)	
12	DI 03	1.0 mm ²	Ground connected is active (B-)	
13	DI 04	1.0 mm ²	Ground connected is active (B-)	
14	DI 05	1.0 mm ²	Ground connected is active (B-)	
15	DI 06	1.0 mm ²	Ground connected is active (B-)	
16	SHIELD/NC	0.5 mm ²	Connected with Speed sensor, shielding line is recommended. (B-) has already connected with speed sensor 2.	
17	MPU -			
18	MPU +			

Installation

Wiring

No.	Function	Cable Size	Remarks	
19	DI 07	1.0 mm ²	Ground connected is active (B-)	Details see Chapter 4.3.2 "Programmable Inputs" on page 70 Details see form 3
20	RELAY 04	1.5 mm ²	Normally closed output, rated 7 A	Details see Chapter 4.3.3 "Programmable Outputs" on page 72
21			Common point of relay	
22			Normally open output, rated 7 A	
CAN (J1939)				
23	SHIELD/NC	/	Impedance-120 Ω shielding wire is recommended, its single-end grounded.	
24	CAN H	0.5 mm ²		
25	CAN L	0.5 mm ²		
26	NC	/	Empty terminal	
RS485				
33	SHIELD/NC	/	Impedance-120 Ω shielding wire is recommended, its single-end grounded	
34	A(+)	0.5 mm ²		
35	B(-)	0.5 mm ²		
36	RELAY 05	2.5 mm ²	Normally closed output, rated 7 A	Details see Chapter 4.3.3 "Programmable Outputs" on page 72
37		2.5 mm ²	Normally open output, rated 7 A	
38		2.5 mm ²	Common pin of relay	
39	RELAY 06	2.5 mm ²	Normally open output, rated 7 A	
40		2.5 mm ²	Common pin of relay	
41 .. 44	not connected			
GENERATOR VOLTAGE AC				
45	L1	1.0 mm ²	Connected to A-phase of genset (2A fuse is recommended)	
46	L2	1.0 mm ²	Connected to B-phase of genset (2A fuse is recommended)	
47	L3	1.0 mm ²	Connected to C-phase of genset (2A fuse is recommended)	
48	N	1.0 mm ²	Connected to N-wire of genset	
GENERATOR CURRENT AC				
49	L1	1.5 mm ²	Outside connected to secondary coil of current transformer(rated 5 A)	
50	L2	1.5 mm ²	Outside connected to secondary coil of current transformer(rated 5 A)	
51	L3	1.5 mm ²	Outside connected to secondary coil of current transformer(rated 5 A)	
52	GND	1.5 mm ²	See "Wiring typical applications" on page 25	
GROUND CURRENT AC				
53	L1	1.5 mm ²	Outside connected to secondary coil of current transformer(rated 5 A)	
54	GND	1.5 mm ²		
55	DI 08	1.0 mm ²	Ground connected is active (B-). Details see form 3.	
56	AI 05	1.0 mm ²	Connected to temperature, oil pressure or level sensors	Details see
57	AI 04	1.0 mm ²		

No.	Function	Cable Size	Remarks
58	AI 03	1.0 mm ²	Connected to oil pressure sensor
59	AI 02	1.0 mm ²	Connected to temperature sensor
60	AI 01	1.0 mm ²	Connected to fuel level sensor
61	COMMON	/	Common terminal of sensor, (B-) has already connected
RS232 (GSM)			
62	GND	0.5 mm ²	Connected to GSM module
63	RxD	0.5 mm ²	
64	TxD	0.5 mm ²	

Wiring typical applications

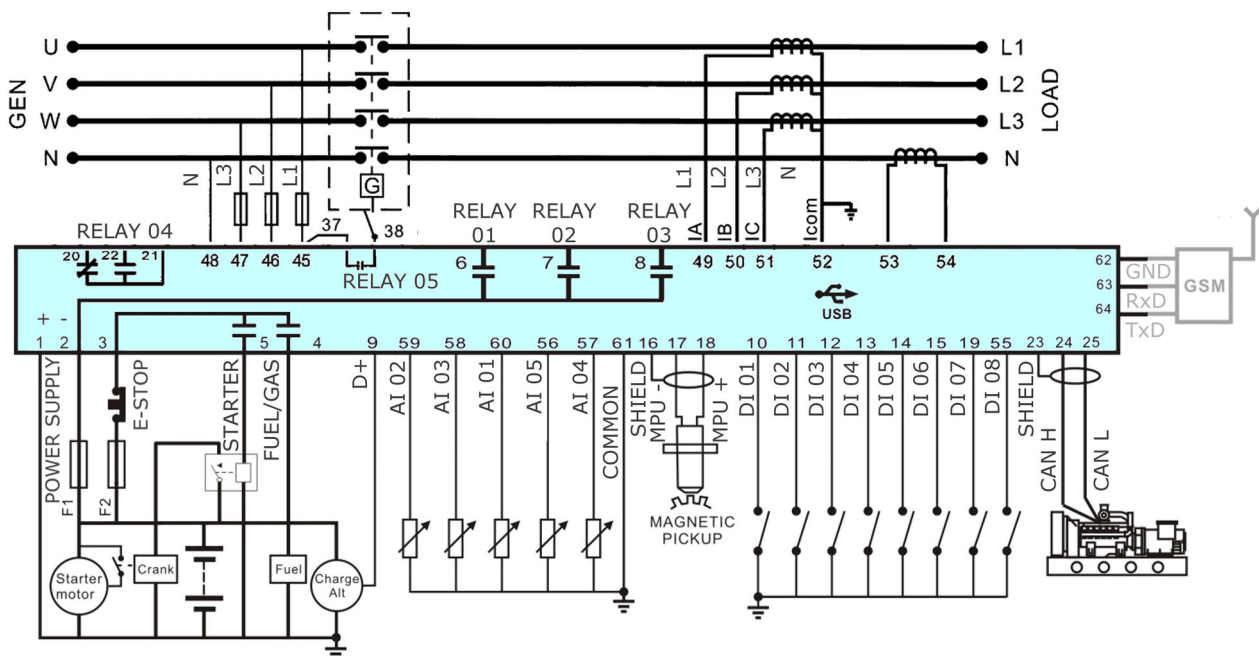

Fig. 6: easYgen-800 wiring of a typical application

Installation

Interfaces > Ethernet Interface Connect...

3.3 Interfaces

Interface Connections

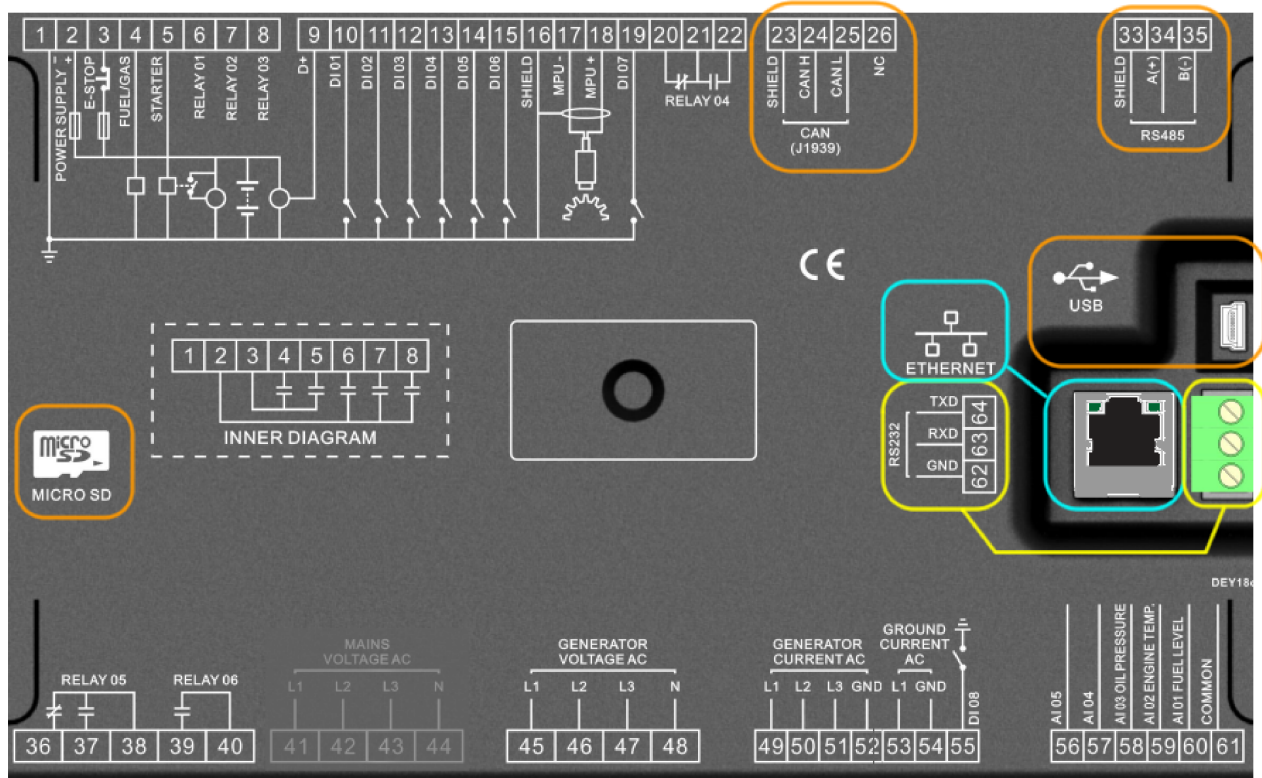

Fig. 7: Interface Connections

Interfaces	Intended use	Remarks
RS-232	For serial communication	For details see Chapter 8 "Technical Specifications" on page 109
RS-485	For Remote Control via Modbus	
J1939	Engine communication J1939 and others	
USB	Configuration tool "ToolKit-SC" access only!	
Ethernet	For Ethernet network communication	
Micro SD card (slot)	To store event logs	

3.3.1 Ethernet Interface Connection

Ethernet Port Terminals

The terminals are:

No.	Name	Description
1	TX+	Transmit Data+
2	TX-	Transceiver Data-
3	RX+	Receive Data+
4	NC	Not connected
5	NC	Not connected
6	RX-	Receive Data-

No.	Name	Description
7	NC	Not connected
8	NC	Not connected

There are two plug-integrated LEDs:

Color	Function	Description
Green	Activity	The LED is flashing when there is activity on the link; otherwise, the LED is off.
Yellow	Link speed	The LED is on when there is a link connection; otherwise, the LED is off.

Direct Cable Connection

Controller and PC are connected directly using a crossover network cable. The crossover cable must fulfill EIA/TIA 568A standard on one end and EIA/TIA 568B on the other end.



If PC network port has Auto MDI/MDIX function, parallel cable can also be used.

Connection via Ethernet Hub/Switch

Controller and PC connection via hub, switch or router needs a parallel cable that fulfills EIA/TIA 568A standard on both ends or EIA/TIA 568B standard on both ends.



If switchboard (or router) network port has Auto MDI/MDIX function, crossover cable can also be used.

3.4 Micro SD Card Slot

General Notes

This easYgen controller supports Micro SD card usage. The controller can regularly save genset operational data (engine speed, temperature, oil pressure, generator voltage, generator frequency, load current, load power, alarm information etc.) to Micro SD card. The format used is a "[filename].DAT" file. It can be read and visualized with ToolKit-SC for the connected device with the SD card inside.



At present the controllers support ≤ 8 GB Micro SD card.

Location of the SD card: see

Enabling SD card usage: see [Chapter 4.2.6 "Configure Interfaces"](#) on page 59

Installation

Install ToolKit-SC

3.5 Install ToolKit-SC

General notes

ToolKit-SC is a software tool for configuration including configuration file management, monitoring, remote control, and custom language management. The ToolKit-SC.exe file is available via download from Woodward web page and device specific download web page.

Please follow installation instruction.



Remove "old" software before update!

Make sure your custom specific configuration and language pack(s) are saved in a separate directory!

For correct installation of the new ToolKit-SC software the "old" ToolKit-SC software must be uninstalled before.

4 Configuration



CAUTION!

Changing controller parameters is allowed in standby mode only! Otherwise, abnormal conditions up to shutdown may happen.

Configuration can be done via

- HMI by front panel buttons
- USB connected PC/laptop by ToolKit-SC configuration software (full edit)

The configuration software ToolKit-SC is part of delivery and (latest edition) can be downloaded from our web site Woodward.com: search for "Toolkit-SC".



Different Discrete Inputs can NOT use one and the same Input Type; otherwise, there are abnormal functions!

E.g.: Contents Setting of Flexible Input Port 4 is Input Type #5 "Lamp test". So #5 "Lamp test" is no longer available for configuration of other Discrete Input Ports.



Different Digital/Relay Outputs can be configured with the same Output Type .

E.g.: Contents Setting of Flexible Output Port 1 is Output Type #18 "Horn". So #18 "Horn" can still be used for other Output ports, too.



Input the sensor curve: X values (resistor) must be arranged increasing from small to large, otherwise, a mistake occurs.

If select sensor type as "None", sensor curve is not working.

If a sensor has an alarm switch only, this sensor's release condition must be configured as "Never", otherwise, a shutdown or warning can occur.

Configuration

Access to the Control > Access Via The Front Panel > Front Panel: Operating and...





4.1 Access to the Control













4.1.1 Access Via The Front Panel

4.1.1.1 Front Panel: Operating and Display Elements



Fig. 8: easYgen-800

Icons	Keys	Description
	STOP	Auto/Manual mode: Stop running generator Stop mode: Reset alarm Lamp test (press at least 3 seconds)
Notes		
During stopping process, press this button again to stop generator immediately.		
	I (START)	MANual mode: Start genset
	MAN (Manual Mode)	Press this key and controller enters into MANual mode
	AUTO (Automatic Mode)	Press this key and controller enters into AUTO mode
	Mute "Horn"/ Alarm acknowledge	Press once: Alarming sound OFF Second time pressing the button: <ul style="list-style-type: none"> ■ Alarm is acknowledged ■ Alarm LED changes from twinkling to permanently illuminated

Icons	Keys	Description
	Close breaker	MANual mode: Switch breaker ON/Close
	Open breaker	MANual mode: Switch breaker OFF/Open
	Up/Increase	1) Screen scroll 2) Setting menu: Up cursor and increase value in
	Down/Decrease	1) Screen scroll 2) Setting menu: Down cursor and decrease value
	Left	1) Screen scroll 2) Setting menu: Left move cursor
	Right	1) Screen scroll 2) Setting menu: Right move cursor
	Set/Confirm	Select viewing area
	Exit	1) Returns to the main menu 2) In settings menu returns to the previous menu
	Warning	
	Alarm	
	Running	
	Genset	
	Load	



In MANual mode:

*Pressing **MAN** and **I** (START) simultaneously will force generator to crank. Successful start will not be judged according to crank disconnect conditions, operator will have to crank the starter motor manually; when operator decides that the engine has fired, he/she should release the button and start output will be deactivated, safety on delay will start.*

Configuration

Access to the Control > Access Via The Front Panel > Front Panel Control



WARNING!

Passwords can be changed by user. Please clearly remember the password after changing. If you forget it, please contact Woodward services and send all device information of the controller page "ABOUT" for legitimation.

4.1.1.2 Front Panel Control

General Notes



Buttons below the screen/display come with dedicated function described in chapter ↪ Chapter 5 "Operation" on page 91.

The configuration via front panel is limited to the current code level and restricted due to the editing/input possibilities of buttons usage. Full access and visibility is available using the configuration (software) tool.

Navigation buttons enable selection of a dedicated menu screen and increase/decrease, next/previous, and enter.

On main menu (top) level:

1. Use next or previous button to switch to next or previous screen
2. Jump to main screen with ↻ button
3. Press and hold ENTER button for more than three seconds
⇒ Main menu opens

In main menu buttons work like typical button managed inputs do:

1. Use down/decrease and up/increase button to select item/ screen
2. Enter with ↵
3. Use down/decrease and up/increase button to select item
4. ... if more than one selection: use next (or previous) button(s) to select item
5. ... Enter with ↵ and continue 4. and 5. as often as necessary
6. Make sure you latest input was entered
7. Go back to upper level with ↻ button
8. Repeat 7. as often as necessary - finally main menu is the latest back screen

4.1.1.2.1 HMI Screens Without Password Level

General Notes

The Main Screen shows a summary of values, modes, messages, and states including a single line diagram. Three additional LEDs left beside the display twinkles if Alarm, Warning, or Running occurs.

Left and right buttons allow to scroll to the other screens in a loop:

- ... from Home screen to ...
- Status
- Engine

- Generator
- Load
- Alarm
- Event log
- Others
- About
- ... and back to Home screen and so on.

"Home" screen includes:

- Gen: voltage, frequency, current, active power, reactive power
- Engine: speed, temperature, oil pressure, battery voltage
- Other states

"Status" screen includes:

- Status* of genset and breakers



**) This easYgen control model has no mains states and so no mains status screen*

"Engine" screen includes:

- Speed, engine temperature, engine oil pressure, fuel level, auxiliary analog 1, auxiliary analog 2, battery voltage, charger voltage, accumulated run time, accumulated start times, user's total run time A, user's total run time B.
- **If connected with J1939 engine via CANBUS port only:** coolant pressure, coolant level, fuel temperature, fuel pressure, inlet temperature, exhaust temperature, turbo pressure, fuel consumption, total fuel consumption and so on.
(Different engine with different parameters)

"Generator" screen includes:

- Phase voltage, line voltage, frequency, phase sequence

"Load" screen includes:

- Current, active power (positive and negative), total active power (positive and negative), reactive power (positive and negative), total reactive power (positive and negative), apparent power, total apparent power,
- power factor (positive and negative), average power factor (positive and negative),
- accumulated energy,
- earth current,
- total electric energy A and B.

Configuration

Access to the Control > Access Via The Front Panel > Front Panel Control

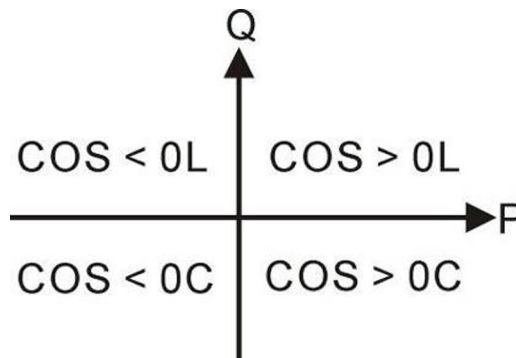

Fig. 9: Power Factor

P Active power

Q Reactive power

Power factor	Conditions	Active power	Reactive power	Remark
COS>0L	P>0, Q>0	Positive	Positive	Positive inductive load
COS>0C	P>0, Q<0	Positive	Negative	Positive capacitive load
COS<0L	P<0, Q>0	Negative	Positive	Negative inductive load
COS<0C	P<0, Q<0	Negative	Negative	Negative capacitive load



**) This easYgen control model has no mains states and so no mains status screen*

“Alarm” screen includes:

- Display all alarm information e.g., warning alarm, shutdown alarm, trip alarm, and trip and stop alarm.



ECU alarms and shutdown alarms:

If the alarm information is displayed, check engine accordingly, otherwise, please check the manual of the generator according to SPN alarm code.

“Event log” screen includes:

- Records all start/stop events (shutdown alarm, trip and stop alarm, manual /auto start or stop) and
- the real time when alarm occurs.

“Others” screen includes:

- Time and Date
- count down time for maintenance
- input/output ports status

“About” screen includes:

- Issue time of software and hardware version
- product PD number

4.1.2 Configure ToolKit-SC



After ToolKit-SC is started it tries to connect to the latest device via the latest selected connection. If application is as before, device's values and settings are read and visualization is updated.

The lower status bar shows the current status of connection and if there is a Warning.

4.1.2.1 Configure Communication

Make sure the connection hardware and your laptop/PC setting are fine.

“COM:” offers for connection:

- TCP/IP
- USB
- COM*



** COM connection collects and presents for selection each RS-232 connection of your laptop/PC.*

Refresh connection with button “Refresh COM”.

4.1.2.2 Manage Configuration Data

Configuration file handling:

- Save with “File → Save Config Strg+S”
- Select default configuration (factory settings) with “File → New Config → [device name]”
- Load a configuration into ToolKit-SC with “File → Open Config Strg+O”
- Print the current configuration (to your default printer) with “File → Print Config”



Configuration update between ToolKit-SC and the device (and vice versa) requests pushing the button “Read config” or “Write config”!

Configuration

Access to the Control > Configure ToolKit-SC > Configure Customized Language...

4.1.2.3 Configure Customized Language

General notes

ToolKit-SC can display English, Chinese, or Traditional Chinese. This is selectable via menu “*Language*” (5).

The easYgen device can use one of three pre-defined languages (same as device: English, Chinese, or Traditional Chinese) or even a customized wording (language):

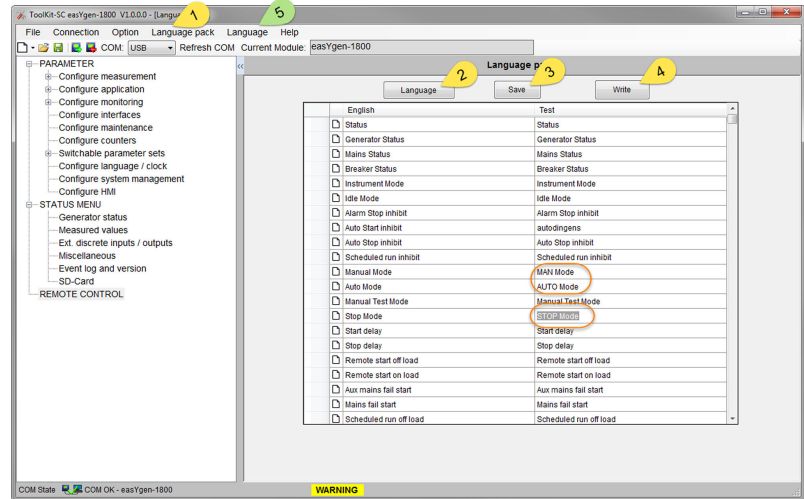

Fig. 10: Configure custom language pack for device (HMI)

Menu “*Language pack*” (1) opens a language pack file management menu. Select a file (2); table will be imported to ToolKit-SC and can be directly customized. Save customized language file with (3) “*Save*”.

To write this customized language into the device - via USB connection, only - needs to push button “*Write*” (4). To use this language data for display needs to select “*Other language*” in menu “*PARAMETER* → *Configure language / clock* → *Language*”.

4.1.3 Access via ToolKit-SC Configuration Tool

ToolKit-SC Screen Overview

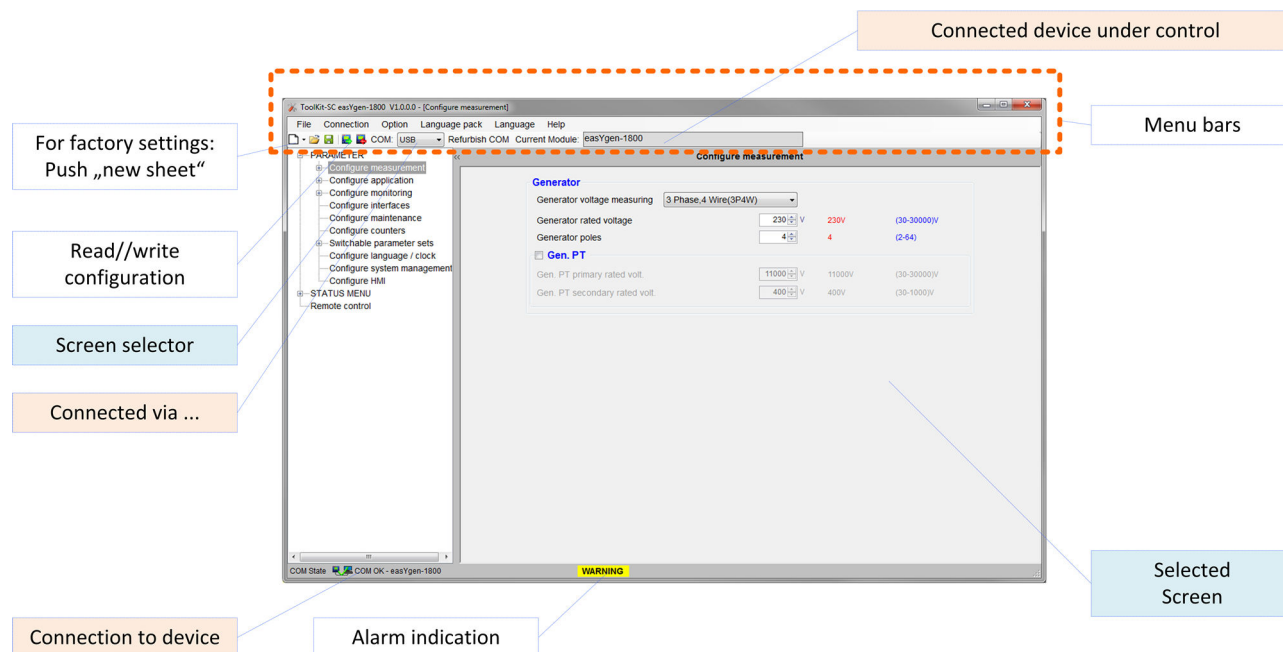

Fig. 11: ToolKit-SC home screen

1. ▶ Open ToolKit-SC on your computer/laptop



ToolKit-SC is installed and connection between your computer and the easYgen device is established

⇒ ToolKit-SC home screen (see above) appears

2. ▶ Accept to read device configuration

⇒ ToolKit-SC presents the current device configuration settings and values

3. ▶ Use the lower left area to select a screen/page to edit

4. ▶ Work with the selected screen at (lower) right side

Configuration

Parameters > Parameter Menu Structure

5. ➤ To import your current ToolKit-SC configuration into the device: Click "Write config(W)" in the menu bar



Your are asked for password. Additionally the splash screen image can be selected.

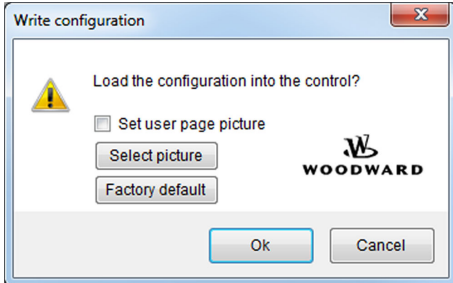

Fig. 12: ToolKit-SC: write configuration

- ⇒ Settings - and if selected splash image - will be transferred to the device and changed immediately

4.1.3.1 Read/Write Configuration

General notes

4.2 Parameters

4.2.1 Parameter Menu Structure

Parameter Menu



Parameter presentation of both HMI (front panel access) and ToolKit-SC do not follow the same structure

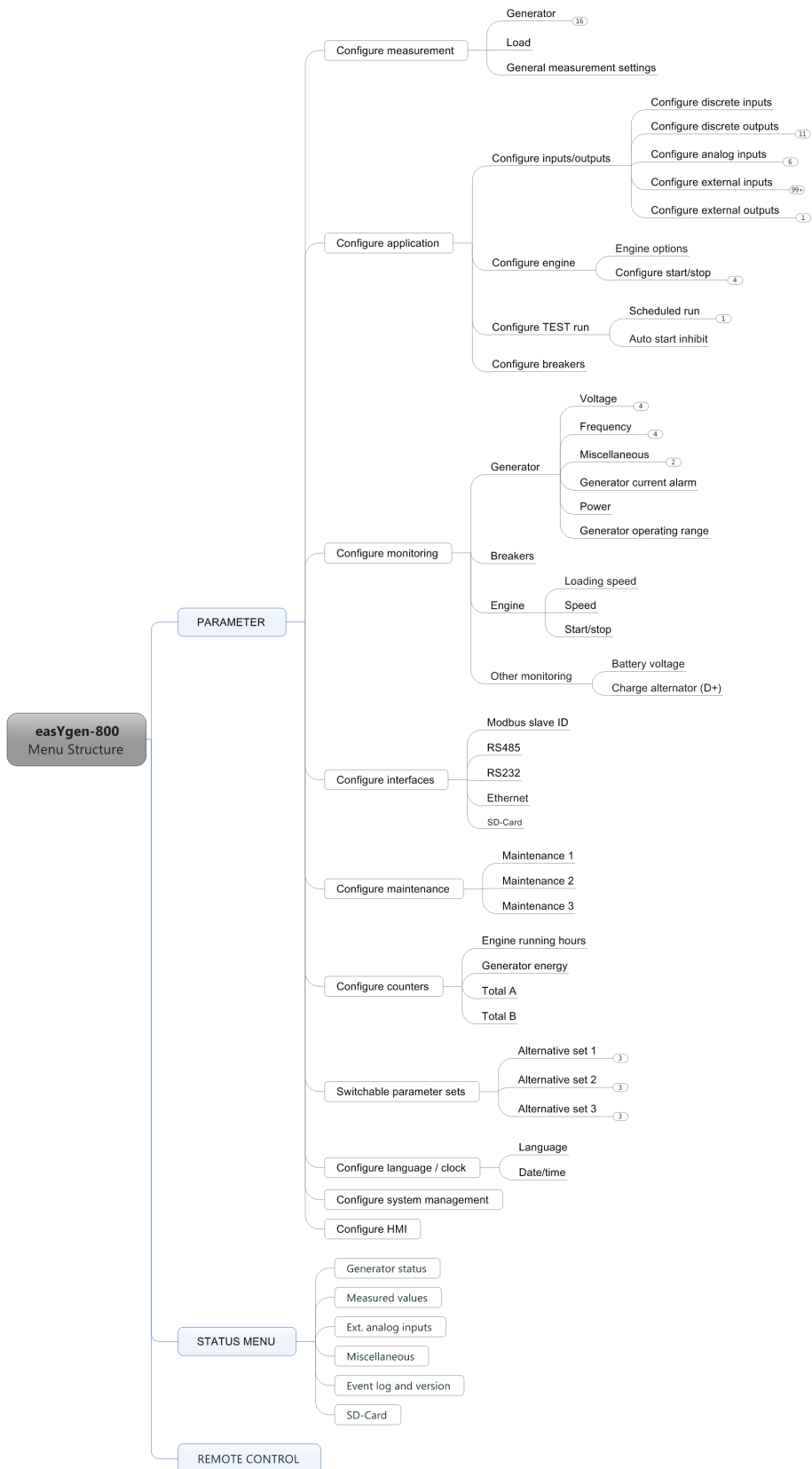





Fig. 13: Menu Structure easYgen-800 - overview



4.2.2 Parameter Settings Menu--HMI Access

1.  Press and hold ENTER button for more than three seconds
⇒ Main menu opens
2.  Select "Configure"
3.  A) Enter password for parameter settings screen



Factory default: 0500, then press return

⇒ Parameter settings list appears

4.  Select step-by-step until desired parameter is editable e.g. using "Right" button
5.  Edit parameter and quit with pushing "Set/Confirm" button
⇒ Parameter is updated with the new setting immediately!



Changing settings with ToolKit-SC needs to push "Write" button before device is updated!



Editor screen is closed automatically after five minutes of inactivity!



Setting is aborted immediately when pushing the "Stop" button!

4.2.3 Configure Measurement

Generator Settings

"PARAMETER → Configure measurement → Generator"

Items	Parameters	Defaults	Description
Generator			Notes We propose to set the generator frequency value as low as possible when cranking, in order to make the starter be separated quickly as soon as crank disconnect.
Generator voltage measuring	0: 3 Phase, 4 Wire (3P4W) 1: 3 Phase, 3 Wire (3P3W) 2: 2 Phase, 3 Wire (2P3W) 3: Single Phase, 2 Wire (1P2W)	3 Phase, 4 Wire (3P4W)	3 Phase, 4 Wire (3P4W): The measurement is performed Line-Neutral and Line-Line: VL12, VL23 and VL31 VL1N, VL2N and VL3N 3 Phase, 3 Wire (3P3W) : The measurement is performed Line-Line. VL12, VL23 and VL31 2 Phase, 3 Wire (2P3W) The measurement is performed Line-Neutral and Line-Line: VL12 VL1N and VL2N Single Phase, 2 Wire (1P2W) The measurement is performed Line-Neutral: VL1N
Generator rated voltage	(30 to 30000) V	230 V	To offer standards for detecting of generator's over/under voltage and loading voltage. (It is primary voltage when using voltage transformer).
Generator poles	(2 to 64)	4	Number of generator poles. Used for calculating starter rotation speed if no speed sensor is used.
Gen. PT	unchecked: Disabled checked: Enabled	disabled	Notes Access to parameters below only if "enabled"
Gen. PT primary rated volt.	30 to 30000 V	100 V	Primary value from the used potential transformer (PT)
Gen. PT secondary rated volt.	30 to 1000 V	100 V	Secondary value from the used potential transformer (PT)

Load Settings

"PARAMETER → Configure measurement → Load"

Items	Parameters	Defaults	Description
Load			
Load CT primary rated current	(5 to 6000)/5	500/5	The ratio of external CT
Load rated current	(5 to 6000) A	500 A	Generator's rated current, standard of load current
Load rated active power	(0 to 6000) kW	276 kW	Generator's rated power, standard of load power

Configuration

Parameters > Configure Application > Configure Inputs and Outpu...

General Measurement Settings

"PARAMETER → Configure measurement
→ General Measurement settings"

Items	Parameters	Defaults	Description
General measurement settings			
System rated frequency	(10.0 to 85.0) Hz	50.0 Hz	Standard for checking over/under frequency
Gnd. CT primary rated current	(5 to 6000)/5	500/5	Primary value from the used ground current transformer (CT)

4.2.4 Configure Application

4.2.4.1 Configure Inputs and Outputs

4.2.4.1.1 Configure Discrete Inputs

Configure Discrete Inputs

"PARAMETER → Configure application
→ Configure discrete inputs"

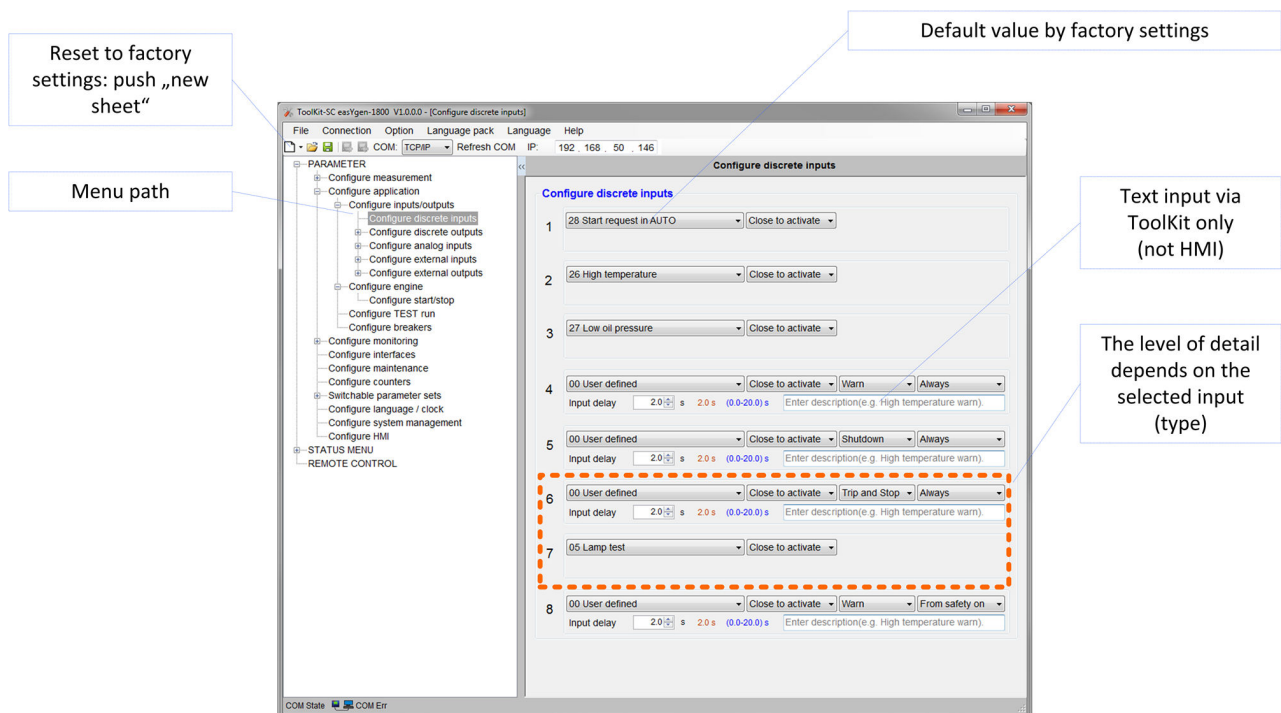

Fig. 14: ToolKit-SC: Config discrete inputs

Items	Parameters	Defaults	Description
Configure discrete inputs ...			
... for discrete inputs 1 to 3:			
(Map Programmable Input)	00 to 52	28 Start request in AUTO	Default of discrete input 1
		26 High temperature	Default of discrete input 2
		27 Low oil pressure	Default of discrete input 3

Items	Parameters	Defaults	Description
			Notes See chapter Chapter 4.3.2 "Programmable Inputs" on page 70 for details
(Adjust to logic)	Close to Activate Open to Activate	Close to Activate	Close to Activate (N.O.): The discrete input is analyzed as "enabled" by energizing the input (normally open). Open to Activate (N.C.): The discrete input is analyzed as "enabled" by de-energizing the input (normally closed).
... for discrete inputs 4 to 8:			
(Map Programmable Input)	00 to 52	00	See chapter Chapter 4.3.2 "Programmable Inputs" on page 70 for details
(Adjust to logic)	Close to Activate Open to Activate	Close to Activate	Close to Activate (N.O.): The discrete input is analyzed as "enabled" by energizing the input (normally open). Open to Activate (N.C.): The discrete input is analyzed as "enabled" by de-energizing the input (normally closed).
(Define alarm type)	Warning Shutdown Trip and Stop Trip Indication	Indication	Alarm type to be released by signal
(Release condition)	From Safety On From Starting Always Never	Never	Condition "switch" of releasing the input signal
Input delay	0.0 to 20.0 s	2.0 s	The input status must be valid for this period of time before it is released
(Description)	Text field for 20 letters	((empty))	Customer specific sensor name

4.2.4.1.2 Configure Discrete Outputs

Configure DC Outputs

The screenshot shows a configuration window titled "DC outputs". It contains a list of discrete outputs. The first output, labeled "1", is configured with "Output(NO)" and "028 Open CB". Above the list, there is a text input field with the placeholder text "Enter description(e.g. Preheat)".

Fig. 15: DC Outputs

"PARAMETER → Configure application
→ Configure discrete outputs → DC outputs"

Items	Parameters	Defaults	Description
DC outputs			Notes For discrete outputs 1 to 3:
(Description)	Text field for 20 letters	((empty with note: Input output remark, as: Preheat))	Customer specific output name
(Adjust to logic)	Output (N.O.) Output (N.C.)	Output (N.O.)	Select according to logic of the connected signal (normally open or normally connected)

Configuration

Parameters > Configure Application > Configure Inputs and Output...

Items	Parameters	Defaults	Description
(Map Programmable Output)	00 to 299	001 Engine flag 1	Default of discrete output 1
		035 Idle control	Default of discrete output 2
		029 Close GCB	Default of discrete output 3
			Notes See chapter Chapter 4.3.3 "Programmable Outputs" on page 72 for details

Configure Relay Outputs

Relay Outputs

Fig. 16: Relay Outputs

"PARAMETER → Configure application
 → Configure discrete outputs → Relay outputs"

Items	Parameters	Defaults	Description
Relay outputs			Notes For discrete outputs 4 to 6:
(Description)	Text field for 20 letters	((empty with note: Input output remark, as: Preheat))	Customer specific output name
(Adjust to logic)	Output (N.O.) Output (N.C.)	Output (N.O.)	Select according to logic of the connected signal (normally open or normally connected)
(Map Programmable Output)	00 to 299	031 Close MCB	Default of discrete output 4
		038 Stop solenoid	Default of discrete output 5
		048 Centralized alarm	Default of discrete output 6
			Notes See chapter Chapter 4.3.3 "Programmable Outputs" on page 72 for details

Configure Custom Sequences & Combinations

General note

easYgen offers customer programmable logic "inside". Two setting types are available and described below:

- Engine flags
- Logic flags

Engine Flags 1 to 6

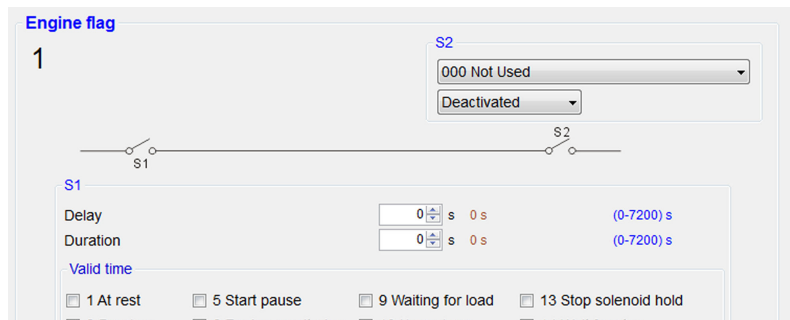

Fig. 17: Engine Flags

Engine flags offer the opportunity to take an available time signal, switch it ON/OFF by a free selectable output. The result (Engine Flag 1..6) is available as input for further control or output/relay directly: Engine Flag X = S1 AND S2.



Fig. 18: Two switches in series

S1 offers the selection of up to 16 valid time parameters (logical OR) with configurable Delay and Duration time. Delay and Duration can be adjusted between 0 and 7200 seconds.

S2 enables the selection of a switching criteria (Programmable Output, see chapter [Chapter 4.3.3 "Programmable Outputs" on page 72](#)), and can be activated/deactivated in general.

The result is available as Programmable Output "Engine flag {X}"; see chapter [Chapter 4.3.3 "Programmable Outputs" on page 72](#).



If both S1-Delay and S1-Duration are "0", S1 is always TRUE.

Logic flags 1 to 6

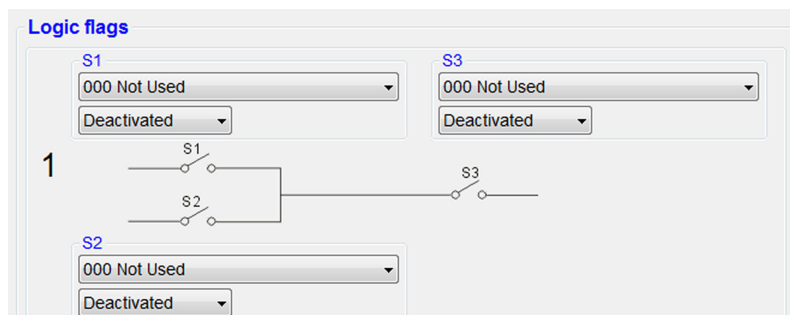

Fig. 19: Logic Flags

Logic Flag offers the opportunity to combine two Programmable Outputs as logical OR and switch it ON/OFF by a third Programmable Output in series. The result (Logical flag 1..6) is available as input for further control or output/relay directly: Logic Flag X = (S1 OR S2) AND S3

Configuration

Parameters > Configure Application > Configure Inputs and Output...

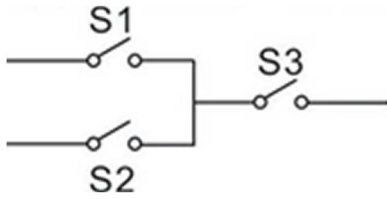



Fig. 20: Logic Flags parallel and in series

Each of the three switches enables the selection of a switching criteria (Programmable Output, see chapter [Chapter 4.3.3 “Programmable Outputs” on page 72](#)) and can be activated/deactivated in general.



The result itself is available too as an Programmable Output “Logic flag {X}”; see chapter [Chapter 4.3.3 “Programmable Outputs” on page 72](#).

4.2.4.1.3 Configure Analog Inputs

“PARAMETER → Configure application
→ Configure inputs/outputs → Configure analog inputs → ...”



Items	Parameters	Defaults	Description
Temperature			
Type	00 to 15	07 SGX	See chapter Chapter 4.3.1 “Programmable Sensors” on page 69
If a type (01 or higher) with curve is selected:	Curve can be loaded ...  ... and/or edited 	-/ (curve)	Notes For temperature curve management and customization.
Wire break alarm	Warn Shutdown None	Warn	Alarm type to be released if wire break is detected
High limit warning	enabled/disabled	enabled	Notes “enabled”: The following related settings will be taken into account
Limit	-50 to 300 °C	95 °C (203 °F)	Release the alarm when sensor value is same or higher than this value and Delay time is over
Return	-50 to 300 °C	93 °C (199 °F)	Cancel the alarm when sensor value is same or lower than this value and Delay time is over
Delay	0 to 3600 s	5 s	The alarm status change must be valid for this period of time before it is released
High limit shutdown	enabled/disabled	enabled	Notes “enabled”: The following related settings will be taken into account
Limit	-50 to 300 °C	98 °C (208 °F)	Release the alarm when sensor value is same or higher than this value and Delay time is over
Delay	0 to 3600 s	3 s	The alarm status change must be valid for this period of time before it is released
Low limit warning	enabled/disabled	disabled	Notes “enabled”: The following related settings will be taken into account
Limit	-50 to 300 °C	70 °C (158 °F)	Release the alarm when sensor value is same or lower than this value and Delay time is over
Return	-50 to 300 °C	75 °C (167 °F)	Cancel the alarm when sensor value is same or higher than this value and Delay time is over
Delay	0 to 3600 s	5 s	The alarm status change must be valid for this period of time before it is released
Engine heater control	enabled/disabled	disabled	Notes “enabled”: The following related settings will be taken into account



Items	Parameters	Defaults	Description
On	-50 to 300 °C	50 °C (-122 °F)	Release the alarm when sensor value is same or lower than this value and Delay time is over
Off	-50 to 300 °C	55 °C (-131 °F)	Cancel the alarm when sensor value is same or higher than this value and Delay time is over
Delay	0 to 3600 min	60 min	The alarm status change must be valid for this period of time before it is released
Engine cooler control	enabled/disabled	disabled	Notes "enabled": The following related settings will be taken into account
On	-50 to 300 °C	80 °C (176 °F)	Release the alarm when sensor value is same or lower than this value and Delay time is over
Off	-50 to 300 °C	75 °C (167 °F)	Cancel the alarm when sensor value is same or higher than this value and Delay time is over
Delay	0 to 3600 min	60 min	The alarm status change must be valid for this period of time before it is released

Items	Parameters	Defaults	Description
Pressure			
Type	00 to 15	07 SGX	See chapter Chapter 4.3.1 "Programmable Sensors" on page 69
If a type (01 or higher) with curve is selected:	Curve can be loaded ...  ... and/or edited 	-/ (curve)	Notes For pressure curve management and customization.
Wire break alarm	Warn Shutdown None	Warn	Alarm type to be released if wire break is detected
Low limit warning	enabled/disabled	enabled	Notes "enabled": The following related settings will be taken into account
Limit	0 to 1000 kPa	124 kPa (17.98 psi, 1.24 bar)	Release the alarm when sensor value is same or lower than this value and Delay time is over
Return	0 to 1000 kPa	138 kPa (20.01 psi, 1.38 bar)	Cancel the alarm when sensor value is same or higher than this value and Delay time is over
Delay	0 to 3600 s	5 s	The alarm status change must be valid for this period of time before it is released
Low limit shutdown	enabled/disabled	enabled	Notes "enabled": The following related settings will be taken into account
Limit	0 to 1000 kPa	103 kPa (14.94 psi, 1.03 bar)	Release the alarm when sensor value is same or lower than this value and Delay time is over
Delay	0 to 3600 s	3 s	The alarm status change must be valid for this period of time before it is released

Configuration

Parameters > Configure Application > Configure Inputs and Outpu...

Items	Parameters	Defaults	Description
Fuel level			
Type	00 to 15	04 SGH	See chapter Chapter 4.3.1 "Programmable Sensors" on page 69
If a type (01 or higher) with curve is selected:	Curve can be loaded ... 	-/-	Notes For fuel level curve management and customization.
	... and/or edited 	(curve)	
Wire break alarm	Warn Shutdown None	Warn	Alarm type to be released if wire break is detected
Low limit warning	enabled/disabled	enabled	Notes "enabled": The following related settings will be taken into account
Limit	0 to 300 %	10 %	Release the alarm when sensor value is same or lower than this value and Delay time is over
Return	0 to 300 %	15 %	Cancel the alarm when sensor value is same or higher than this value and Delay time is over
Delay	0 to 300 %	5 s	The alarm status change must be valid for this period of time before it is released
Fuel pump control	enabled/disabled	disabled	Notes "enabled": The following related settings will be taken into account
On	0 to 300 %	10 %	Release the alarm when sensor value is same or lower than this value and Delay time is over
Off	0 to 300 %	80 %	Cancel the alarm when sensor value is same or higher than this value and Delay time is over
Max time on	0 to 3600 s	60 s	The alarm status change must be valid for this period of time before it is released

Items	Parameters	Defaults	Description
Analog input {X}			Notes {X} is a placeholder for Analog Inputs 4 and 5
Sensor type	None	None	Select sensor type
	Temperature sensor Pressure sensor Fuel level Sensor		Notes With selection of the sensor type, all limit warnings and shutdowns below are related to the according range, default value and units; marked with ""
Description	Text field for 20 letters	((empty))	Customer specific sensor name
Type	00 to 15	00 Not used	See chapter Chapter 4.3.1 "Programmable Sensors" on page 69
If a type (01 or higher) with curve is selected:	Curve can be loaded ... 	-/-	Notes For fuel level curve management and customization.
	... and/or edited 	(curve)	
Wire break alarm	Warn Shutdown None	Warn	Alarm type to be released if wire break is detected

Items	Parameters	Defaults	Description
Enabled if a sensor type is selected:			Notes * is filled with the related values and units (temperature, pressure, level)
High limit warning	enabled/disabled	disabled	Notes "enabled": The following related settings will be taken into account
Limit	*	*	Release the alarm when sensor value is same or higher than this value and Delay time is over
Return	*	*	Cancel the alarm when sensor value is same or lower than this value and Delay time is over
Delay	0 to 3600	5 s	The alarm status change must be valid for this period of time before it is released
High limit shutdown	enabled/disabled	disabled	Notes "enabled": The following related settings will be taken into account
Limit	*	*	Release the alarm when sensor value is same or higher than this value and Delay time is over
Delay	0 to 3600	5 s	The alarm status change must be valid for this period of time before it is released
Low limit warning	enabled/disabled	disabled	Notes "enabled": The following related settings will be taken into account
Limit	*	*	Release the alarm when sensor value is same or lower than this value and Delay time is over
Return	*	*	Cancel the alarm when sensor value is same or higher than this value and Delay time is over
Delay	0 to 3600	5 s	The alarm status change must be valid for this period of time before it is released
Low limit shutdown	enabled/disabled	disabled	Notes "enabled": The following related settings will be taken into account
Limit	*	*	Release the alarm when sensor value is same or higher than this value and Delay time is over
Delay	*	5 s	The alarm status change must be valid for this period of time before it is released

Items	Parameters	Defaults	Description
Displayed units			
Pressure	kPa	kPa	Select local pressure unit for display
	psi		
	bar		
Temperature	°C	°C	Select local temperature unit for display
	°F		

Configuration

Parameters > Configure Application > Configure Inputs and Outpu...

4.2.4.1.4 Configure External Inputs

Configure External Discrete Inputs

"PARAMETER → Configure application

→ Configure inputs/outputs → Configure external inputs

→ Configure external inputs → Configure ext. discr. inputs

→ Ext. discrete inputs 1-8(9-16)"

Configure each external discrete input as described below:

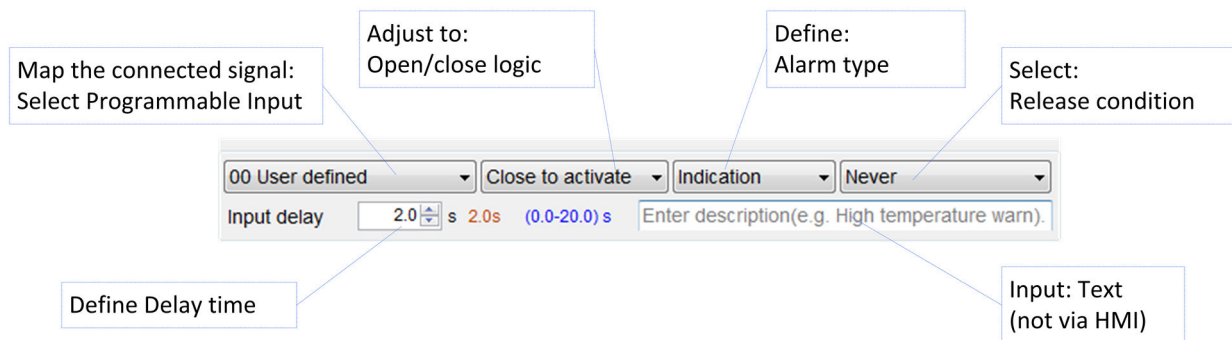

Fig. 21: Edit External Discrete Input settings

Items	Parameters	Defaults	Description
Ext. discrete inputs 1-16 (1-8)	enabled/disabled	disabled	Notes All 16 external discrete inputs are enabled/disabled together. 2nd page on ToolKit-SC depends on this selection (on first page)! "enabled": The following related settings will be taken into account
Communication failure action	Warn Shutdown None	Warn	Alarm type to be released if wire break is detected
Notes For Ext. discrete inputs 1 to 8 and 9 to 16 (two screens):			
Map Programmable Input	00 to 52	00	See chapter Chapter 4.3.2 "Programmable Inputs" on page 70 for details
(Adjust to logic)	Close to Activate Open to Activate	Close to Activate	Select according to logic of the connected signal
(Define alarm type)	Warn Shutdown Trip and Stop Trip Indication	Indication	Alarm type to be released by signal
(Release condition)	From Safety On From Starting Always Never	Never	Condition "switch" of releasing the input signal
Input delay	0.0 to 20.0 s	2.0 s	The input status must be valid for this period of time before it is released
(Description)	Text field for 20 letters	((empty))	Customer specific sensor name

4.2.4.1.5 Configure External Outputs

Configure External Discrete Outputs

*“PARAMETER → Configure application
 → Configure inputs/outputs → Configure external inputs
 → Configure external inputs → Configure ext. discr. inputs
 → Ext. discrete inputs 1-8(9-16)”*

Configure each external discrete input as described below:

Items	Parameters	Defaults	Description
Ext. output enable	enabled/disabled	disabled	Notes All 16 external discrete inputs are enabled/disabled together. “enabled”: The following related settings will be taken into account
Communication failure action	Warn Shutdown Trip and Stop Trip Indication	Warn	Alarm type to be released if wire break is detected
Notes For Ext. discrete outputs 1 to 16:			
(Adjust to logic)	Output (N.O.) Output (N.C.)	Output (N.O.)	Select according to logic of the connected signal (normally open or normally connected)
(Map Programmable Output)	00 to 299	00 Not Used	See chapter ↗ <i>Chapter 4.3.3 “Programmable Outputs” on page 72</i> for details

4.2.4.2 Configure Engine

“PARAMETER → Configure application → Configure engine”

Items	Parameters	Defaults	Description
Engine Type			
Engine type	00 to 39	00 Conventional Engine	Default: Conventional genset (not J1939). When connected to J1939 engine, choose the corresponding type, see chapter ↗ <i>Chapter 7.1 “J1939” on page 103</i> .
Engine rated speed	(0 to 6000) r/min	1500 r/min	Offer standard to judge over/under/loading speed
MPU flywheel teeth	10 to 300	118	Tooth number of one 360° rotation, for judging of crank disconnect conditions and inspecting of engine speed
ECU Inc. / Dec. steps	1 to 30 r/min	5 r/min	The speed offset (J1939) works in combination with input sources (increase/decrease speed). The input sources can be configured to discrete inputs in order to adjust the speed of the engine. With an additional parameter the speed variation can be adjusted (Inc. / Dec. step 1 to 20 rpm) but the overall offset is limited to ±10 % from rated speed. The speed offset is active as long as the engine is in operation and resets automatically to zero if the engine stops.
Configure Start/Stop			
Start Attempts	1 to 10 times	3	Max. number of crank attempts. When reaching this number, controller will send start failure signal.
Start timers			

Configuration

Parameters > Configure Application > Configure TEST Run

Items	Parameters	Defaults	Description
Start delay	0 to 3600 s	1 s	Time from remote start signal is active to start genset
Starter time	3 to 60 s	8 s	Time of starter power up
Preglow time	0 to 3600 s	0 s	Time of pre-powering heat plug before starter is powered up
Start pause time	3 to 60 s	10 s	The waiting time before second power up when engine start failed
Engine monitoring delay time	0 to 3600 s	10 s	Alarms for low oil pressure, high temperature, under speed, under frequency /voltage, charge fail are inactive.
Start idle time	0 to 3600 s	0 s	Idle running time of genset when starting
Warming up time	0 to 3600 s	10 s	Warming time between genset switch On and normal running
Stop timers			
Stop delay	0 to 3600 s	1 s	Time from remote start signal is active to start genset
Cool down time	0 to 3600 s	10 s	Radiating time before genset stop, after it unloads
Stop idle time	0 to 3600 s	0 s	Idle running time when genset stop
Stop solenoid hold	0 to 3600 s	20 s	The time of powering up the electromagnet during stop procedure
Stop time of engine	0 to 3600 s	0 s	There is a time accepted for a regular stop to standby. Exceeding the "fail to stop delay" time (e.g. crank disconnect conditions contain oil pressure, and oil pressure drops quite slowly if genset stops), then this time is activated.
Gas Engine Timers	enabled/disabled	disabled	When gas engine timer enabled, fuel oil output is used for controlling gas valve
Choke on time	0-60 s	0 s	Gas enrichment control output time when start engine
Gas on delay	0-60 s	0 s	When engine started, it starts to output after the preset time delay
Ignition off delay	0-60 s	0 s	When gas valve closed, it stop to output after the preset delay
Firing Speed			
Firing speed Hz	enabled/disabled	enabled	
	0 to 200 %	24 %	When generator frequency higher than the set value, starter will be disconnected. See the installation instruction.
Firing speed RPM	enabled/disabled	enabled	
	0 to 200 %	24 %	When generator speed higher than the set value, starter will be disconnected. See the installation instruction.
Oil Pressure	enabled/disabled	enabled	
	0 to 1000 kPa	200 kPa	When generator oil pressure higher than the set value, starter will be disconnected. See the installation instruction.

4.2.4.3 Configure TEST Run

"PARAMETER → Configure application → Configure TEST run"

Items	Parameters	Defaults	Description
Scheduled run	enabled/disabled	disabled	Notes "enabled": The following related settings will be taken into account
Run mode	Off load On load	Off load	

Items	Parameters	Defaults	Description
Schedule period	Monthly	Monthly	Notes <i>"Custom weekly"</i> : A table with 16 x setting blocks appear, each with ... <ul style="list-style-type: none"> ■ Start time (weekly) to select a week day ■ Start time (hh:mm) ■ Duration (m) The TEST run is disabled if duration is "0" minutes. Max. duration is 30000 minutes.
	Weekly		
	Daily		
	Custom weekly		
Time (Day)	1 to 31	1	<i>"Monthly"</i> : Select a week day
	Sunday, to Saturday	Sunday	<i>"Weekly"</i> : Select a week day
Time (hour)	0 to 24 h	0 (o'clock)	Define the start time (hour)
Time (minute)	0 to 59	0	Define the start time (minute)
Duration	0 to 30000 min	30 min	Select the duration for scheduled run
Auto start inhibit	enabled/disabled	disabled	Notes <i>"enabled"</i> : The following related settings will be taken into account
Schedule period	Monthly	Monthly	
	Weekly		
	Daily		
Time (Day)	1 to 31	1	<i>"Monthly"</i> : Select a week day
	Sunday, to Saturday	Sunday	<i>"Weekly"</i> : Select a week day
Time (hour)	0 to 24 h	0 (o'clock)	Define the start time (hour)
Time (minute)	0 to 59	0	Define the start time (minute)
Duration	0 to 30000 min	30 min	Select the duration for scheduled run

4.2.4.4 Configure Breakers

"PARAMETER → Configure application → Configure breakers"

Items	Parameters	Defaults	Description
Configure breakers			
Closing time	0.0 to 20.0 s	5.0 s	Pulse width of generator switch ON.
			Notes This is the duration from the closing pulse for GCB as well. If the time is configured to "zero" the closing pulse acts as a steady pulse.
Opening time	0.0 to 20.0 s	3.0 s	Pulse width of generator switch OFF
			Notes This is the duration from the opening pulse for GCB as well.

Configuration

Parameters > Configure Monitoring > Monitoring Generator

4.2.5 Configure Monitoring

4.2.5.1 Monitoring Generator

Monitoring Voltage

"PARAMETER → Configure monitoring → Generator → Voltage"

Items	Parameters	Defaults	Description
Overvoltage warning	enabled/disabled	disabled	Notes "enabled": The following related settings will be taken into account
	Limit	0 to 200 %	110 % (253 V) Release the alarm when sensor value is same or higher than this value and Delay time is over
	Return	0 to 200 %	108 % (248 V) Cancel the alarm when sensor value is same or lower than this value and Delay time is over
	Delay	0 to 3600 s	5 s The alarm status change must be valid for this period of time before it is released
Overvoltage shutdown	enabled/disabled	enabled	Notes "enabled": The following related settings will be taken into account
	Limit	0 to 200 %	120 % (276 V) Release the alarm when sensor value is same or higher than this value and Delay time is over
	Delay	0 to 3600 s	3 s The alarm status change must be valid for this period of time before it is released
	Limit	0 to 200 %	84 % (193 V) Release the alarm when sensor value is same or lower than this value and Delay time is over
Undervoltage warning	enabled/disabled	enabled	Notes "enabled": The following related settings will be taken into account
	Limit	0 to 200 %	86 % (197 V) Cancel the alarm when sensor value is same or higher than this value and Delay time is over
	Delay	0 to 3600 s	5 s The alarm status change must be valid for this period of time before it is released
	Limit	0 to 200 %	80 % (184 V) Release the alarm when sensor value is same or lower than this value and Delay time is over
Undervoltage shutdown	enabled/disabled	enabled	Notes "enabled": The following related settings will be taken into account
	Limit	0 to 200 %	80 % (184 V) Release the alarm when sensor value is same or lower than this value and Delay time is over
	Delay	0 to 3600 s	3 s The alarm status change must be valid for this period of time before it is released
	Limit	0 to 200 %	110 % (55.0 Hz) Release the alarm when sensor value is same or higher than this value and Delay time is over
Overfrequency warning	enabled/disabled	enabled	Notes "enabled": The following related settings will be taken into account
	Return	0 to 200 %	108 % (54.0 Hz) Cancel the alarm when sensor value is same or lower than this value and Delay time is over

Monitoring Frequency

"PARAMETER → Configure monitoring → Generator → Frequency"

Items	Parameters	Defaults	Description
Overfrequency warning	enabled/disabled	enabled	Notes "enabled": The following related settings will be taken into account
	Return	0 to 200 %	108 % (54.0 Hz) Cancel the alarm when sensor value is same or lower than this value and Delay time is over
Limit	0 to 200 %	110 % (55.0 Hz) Release the alarm when sensor value is same or higher than this value and Delay time is over	

Items	Parameters	Defaults	Description
Delay	0 to 3600 s	5 s	The alarm status change must be valid for this period of time before it is released
Overfrequency shutdown	enabled/disabled	enabled	Notes "enabled": The following related settings will be taken into account
Limit	0 to 200 %	114 % (57.0 Hz)	Release the alarm when sensor value is same or higher than this value and Delay time is over
Delay	0 to 3600 s	2 s	The alarm status change must be valid for this period of time before it is released
Underfrequency warning	enabled/disabled	enabled	Notes "enabled": The following related settings will be taken into account
Limit	0 to 200 %	84 % (42.0 Hz)	Release the alarm when sensor value is same or lower than this value and Delay time is over
Return	0 to 200 %	86 % (43.0 Hz)	Cancel the alarm when sensor value is same or higher than this value and Delay time is over
Delay	0 to 3600 s	5 s	The alarm status change must be valid for this period of time before it is released
Underfrequency shut-down	enabled/disabled	enabled	Notes "enabled": The following related settings will be taken into account
Limit	0 to 200 %	80 % (40.0 Hz)	Release the alarm when sensor value is same or lower than this value and Delay time is over
Delay	0 to 3600 s	3 s	The alarm status change must be valid for this period of time before it is released

Monitoring Miscellaneous

"PARAMETER → Configure monitoring → Generator
→ Miscellaneous"

Items	Parameters	Defaults	Description
Ground fault	enabled/disabled	disabled	Notes "enabled": The following related settings will be taken into account
Action	Warn Shutdown Trip and Stop Trip	Warn	Alarm type to be released if wire break is detected
Limit	0 to 100 %	10 % (50 A)	Release the alarm when sensor value is same or higher than this value and Delay time is over
Delay multiplier	0.1 to 1.6	0.1	The "Delay multiplier" defines the grade of reaction on the ratio of current ground current to overcurrent setting. A low value means fast reaction (short delay time); the greater the value the slower reaction because longer delay time.
Enable generator phase rotation fail	enabled/disabled	enabled	
Enable generator voltage asymmetry	enabled/disabled	enabled	

Configuration

Parameters > Configure Monitoring > Monitoring Generator

Monitoring Generator Current Alarm

"PARAMETER → Configure monitoring → Generator → Generator current alarm"

Items	Parameters	Defaults	Description
Generator current alarm	enabled/disabled	enabled	Notes "enabled": The following related settings will be taken into account
Limit	0 to 200 %	120 % (600 A)	Release the alarm when sensor value is same or higher than this value and Delay time is over
Action	Warn Shutdown Trip and Stop Trip	Warn	Alarm type to be released if wire break is detected
Type	Definite time IDMT (Inverse Definite Minimum Time)	Definite time	
If Type is "Define Time": Delay	0 to 3600 s	10 s	The alarm status change must be valid for this period of time before it is released
If Type is "IDMT ...": Delay multiply	1 to 36	36	"Multiply" defines the grade of reaction on the ratio of generator current to overcurrent setting. A low value means fast reaction (short delay time); the greater the value the slower reaction because longer delay time.

Monitoring Power

"PARAMETER → Configure monitoring → Generator → Power"

Items	Parameters	Defaults	Description
Reserve power	enabled/disabled	disabled	Notes "enabled": The following related settings will be taken into account
Action	Warn Shutdown Trip and Stop Trip	Warn	Alarm type to be released if wire break is detected
Limit	0 to 200 %	10 % (27 kW)	Release the alarm when sensor value is same or higher than this value and Delay time is over
Return	0 to 200 %	5 % (13 kW)	
Delay	0 to 3600 s	5 s	The alarm status change must be valid for this period of time before it is released
Overload	enabled/disabled	disabled	Notes "enabled": The following related settings will be taken into account
Action	Warn Shutdown Trip and Stop Trip	Warn	Alarm type to be released if wire break is detected
Limit	0 to 200 %	110 % (303 kW)	Release the alarm when sensor value is same or higher than this value and Delay time is over

Items	Parameters	Defaults	Description
Return	0 to 200 %	105 % (289 kW)	
Delay	0 to 3600 s	5 s	The alarm status change must be valid for this period of time before it is released

Monitoring Generator Operating Range

"PARAMETER → Configure monitoring → Generator → Generator operating range"

Items	Parameters	Defaults	Description
Generator operating range			
Loading voltage	0 to 200 %	85 % (196 V)	In AUTO mode the GCB closes if the actual generator voltage is higher than the configured loading voltage.
Loading frequency	0 to 200 %	85 % (42.5 Hz)	In AUTO mode the GCB closes if the actual generator frequency is higher than the configured loading frequency.

4.2.5.2 Monitoring Breakers

Monitoring Breakers

"PARAMETER → Configure monitoring → Breakers"

Items	Parameters	Defaults	Description
Enable breaker feedback monitoring	enabled/disabled	disabled	With enabled breaker feedback monitoring, the device uses the configured discrete inputs for the breaker status.
Check fail warn(ing)	enabled/disabled	disabled	Enable the breaker feedback monitoring. This requires the "Enable breaker feedback monitoring".
Check time	0.0 to 20.0 s	5.0 s	Breaker monitoring delay time. After the configured check time, a breaker failure alarm sounds.

4.2.5.3 Monitoring Engine

Monitoring Loading Speed

"PARAMETER → Configure monitoring → Engine → Loading speed"

Items	Parameters	Defaults	Description
Loading speed	0 to 100 %	90 % (1350 r/min)	In AUTO mode the GCB closes if the actual engine speed is higher than the configured loading speed. This function is only used if the MPU input is used.

Configuration

Parameters > Configure Monitoring > Monitoring Engine

Monitoring Speed

"PARAMETER → Configure monitoring → Engine → Speed"

Items	Parameters	Defaults	Description
Overspeed warning	enabled/disabled	enabled	Notes "enabled": The following related settings will be taken into account
Limit	0 to 200 %	110 % (1650 r/min)	Release the alarm when sensor value is same or higher than this value and Delay time is over
Return	0 to 200 %	108 % (1620 r/min)	Cancel the alarm when sensor value is same or lower than this value and Delay time is over
Delay	0 to 3600 s	5 s	The alarm status change must be valid for this period of time before it is released
Overspeed shutdown	enabled/disabled	enabled	Notes "enabled": The following related settings will be taken into account
Limit	0 to 200 %	114 % (1710 r/min)	Release the alarm when sensor value is same or higher than this value and Delay time is over
Delay	0 to 3600 s	2 s	The alarm status change must be valid for this period of time before it is released
Underspeed warning	enabled/disabled	enabled	Notes "enabled": The following related settings will be taken into account
Limit	0 to 200 %	86 % (1290 r/min)	Release the alarm when sensor value is same or lower than this value and Delay time is over
Return	0 to 200 %	90 % (1350 r/min)	Cancel the alarm when sensor value is same or higher than this value and Delay time is over
Delay	0 to 3600 s	5 s	The alarm status change must be valid for this period of time before it is released
Underspeed shutdown	enabled/disabled	enabled	Notes "enabled": The following related settings will be taken into account
Limit	0 to 200 %	80 % (1200 r/min)	Release the alarm when sensor value is same or lower than this value and Delay time is over
Delay	0 to 3600 s	3 s	The alarm status change must be valid for this period of time before it is released
Loss of speed signal			
Delay	0 to 3600 s	5 s	The alarm status change must be valid for this period of time before it is released
Action	Warn Shutdown	Warn	

Monitoring Start/Stop

"PARAMETER → Configure monitoring → Engine → Start/Stop"

Items	Parameters	Defaults	Description
Shutdown malfunction			
Shutdown malfunction delay	0 to 3600 s	0 s	Time between ending of genset idle delay and stopped when "Stop solenoid Hold" is set as "0" or Time between ending of Stop solenoid hold delay and stopped when "Stop solenoid Hold" time is not "0".

4.2.5.4 Other Monitoring

Monitoring Battery Voltage

*"PARAMETER → Configure monitoring → Engine
→ Other monitoring → Battery voltage"*

Items	Parameters	Defaults	Description
Rated	0.0 to 60.0 V	24.0 V	
Overvoltage	enabled/disabled	enabled	Notes "enabled": The following related settings will be taken into account
Limit	0 to 200 %	120 % (28.8 V)	Release the alarm when sensor value is same or higher than this value and Delay time is over
Return	0 to 200 %	115 % (27.6 V)	Cancel the alarm when sensor value is same or lower than this value and Delay time is over
Delay	0 to 3600 s	60 s	The alarm status change must be valid for this period of time before it is released
Undervoltage	enabled/disabled	enabled	Notes "enabled": The following related settings will be taken into account
Limit	0 to 200 %	85 % (20.4 V)	Release the alarm when sensor value is same or lower than this value and Delay time is over
Return	0 to 200 %	90 % (21.6 V)	Cancel the alarm when sensor value is same or higher than this value and Delay time is over
Delay	0 to 3600 s	60 s	The alarm status change must be valid for this period of time before it is released

Monitoring Charge Alternator (D+)

*"PARAMETER → Configure monitoring → Engine
→ Other monitoring → Charge alternator"*

Items	Parameters	Defaults	Description
Charge alternator (D+)	enabled/disabled	enabled	Notes "enabled": The following related settings will be taken into account
Limit	0.0 to 60.0 V	8.0 V	Release the alarm when sensor value is same or higher than this value and Delay time is over
Return	0.0 to 60.0 V	10.0 V	Cancel the alarm when sensor value is same or lower than this value and Delay time is over
Delay	0 to 3600 s	10 s	The alarm status change must be valid for this period of time before it is released

4.2.6 Configure Interfaces

"PARAMETER → Configure interfaces"

Items	Parameters	Defaults	Description
Modbus slave ID			
Modbus slave ID	1 to 254	1	
RS485			

Configuration

Parameters > Configure Interfaces > Configure GSM Module

Items	Parameters	Defaults	Description
Baud rate	2400, 4800, 9600, 19200	19200	
Data bit	8		
Parity bit	None		
Stop bit	2	1, 2	
Ethernet	enabled/disabled	enabled	Notes "enabled": The following related settings will be taken into account
IP address	XXX.XXX.XXX.XXX	192.168.0.1 44	
Subnet mask	XXX.XXX.XXX.XXX	255.255.255 .0	
Gateway	XXX.XXX.XXX.XXX	192.168.0.1	
Gateway	XXX.XXX.XXX.XXX	192.168.0.1	
MAC address	XX-XX-XX-XX-XX-XX	25-25-25-25 -25-25	
SD card			
Enable SD card	enabled/disabled	disabled	Notes "enabled": SD card is used to save Event Logs as an "[date].dat" file every week

4.2.6.1 Configure GSM Module

General Notes

The external GSM module enables communication via radio frequency transmission e.g. with a mobile phone.

"PARAMETER → Configure interfaces → GSM module"

Items	Parameters	Defaults	Description
GSM enable	enabled/disabled	enabled	Notes "enabled": The connected external GSM module will be used for communication
Phone number	Max. 20 digits	((empty))	Phone number of the (radio) connected mobile phone/device.

4.2.6.1.1 GSM Short Message Alarm

When controller detects an alarm, it will send short message to phone automatically (if enabled).



All shutdown, trip and stop and trip alarms will be sent to the pre-set phone. Warnings are sent to the phone according to the settings.

4.2.6.1.2 GSM Short Message Remote Control

General notes

Users send “SMS Order” message to GSM module, then controller will act according to this remote signal and pass back corresponding operation information.



International area code must be added. E.g. USA 001...

“SMS orders” must be typed-in in the form described below e.g. all letters must be capital!

If an easYgen model does not support an information or detail, value will be empty.

The following “SMS Orders” are supported:

SMS Order	Pass back Information	Description	
SMS GENSET	GENSETALARM	Shutdown alarm occurred	status of genset
	SYSTEM IN STOP MODE GENSET AT REST	Current mode: STOP Genset: standstill	
	SYSTEM IN MANUAL MODE GENSET AT REST	Current mode: MAN Genset: standstill	
	SYSTEM IN AUTO MODE GENSET AT REST	Current mode: STOP Genset: standstill	
	SYSTEM IN STOP MODE GENSET IS RUNNING	Current mode: STOP Genset: running	
	SYSTEM IN MANUAL MODE GENSET IS RUNNING	Current mode: STOP Genset: running	
	SYSTEM IN AUTO MODE GENSET AT RUNNING	Current mode: STOP Genset: running	
SMS START	GENSET ALARM	Shutdown alarm or trip alarm occurred	Start genset
	STOP MODE NOT START	Cannot start in STOP mode	
	SMS START OK	Start in MAN mode	
	AUTO MODE NOT START	Cannot start in AUTO mode	
SMSSTOP MODE	SMS STOP OK	Current mode: STOP	
SMS MANUAL MODE	SMS MANUAL MODE OK	Current mode: MAN	
SMSAUTO MODE	SMS AUTO MODE OK	Current mode: AUTO	
SMS DETAIL	Pass back information set by controller configuration	Delivers the configured information of the genset: Working mode, mains voltage, generator voltage, load current, mains frequency, generator frequency, active power, apparent power, power factor, battery voltage, D+ voltage, water temperature, oil pressure, oil level, engine speed, total running time, genset status, and alarm status.	
SMS INHIBIT START	INHIBIT START OK	Generator START will be inhibited.	
SMS PERMIT START	PERMIT START OK	Discharge the inhibit START signal.	

Configuration

Parameters > Configure Interfaces > Configure Ethernet Interfa...

4.2.6.2 Configure Ethernet Interface

General Notes

The Ethernet Interface is used for controller monitoring and has two connection modes:

- Network Client mode
and
- Web Server mode



Change of controller's network parameters (e.g. IP address, sub network mask) take effect only after controller restart.

4.2.6.2.1 Network Client Mode

When the controller is used as network client, it can be monitored via network port using TCP ModBus protocol:

Connect as Network Client

1. ➤ Set IP address and sub network of the controller.



The IP address must be in the same network segment as the IP address of monitoring equipment (e.g. PC).

Example: Monitoring equipment IP address is 192.168.0.16, controller IP can be 192.168.0.18, sub network mask (for both) is 255.255.255.0

2. ➤ Connect the controller. It can be connected to the monitoring equipment directly using network cable or via a switchboard.
3. ➤ The communication between controller and monitoring equipment is carried out using TCP Modbus protocol.



This Network Client mode enables to set parameters. A communication protocol is available.

4.2.6.2.2 Web Server Mode

If the controller acts as a web server, it can be controlled via web browser using PC:

Connect as Web Serer

1. ➤ Set IP address and sub network of the controller.



The IP address must be in the same network segment as the IP address of monitoring equipment (e.g. PC).

Example: Monitoring equipment IP address is 192.168.50.144, controller IP can be 192.168.50.146, sub network mask (for both) is 255.255.255.0

2. ➤ Connect controller to the monitoring equipment directly using network cable or via a switchboard (hub/switch).
3. ➤ In order to monitor the controller, use IP address as URL with a web browser e.g.: <http://192.168.50.146>



This Web Server mode is for visualization only - no parameter change access.

With "Operate ➔ Stop/Manual/Start/Auto" a basic remote control is accessible on the lower right corner.

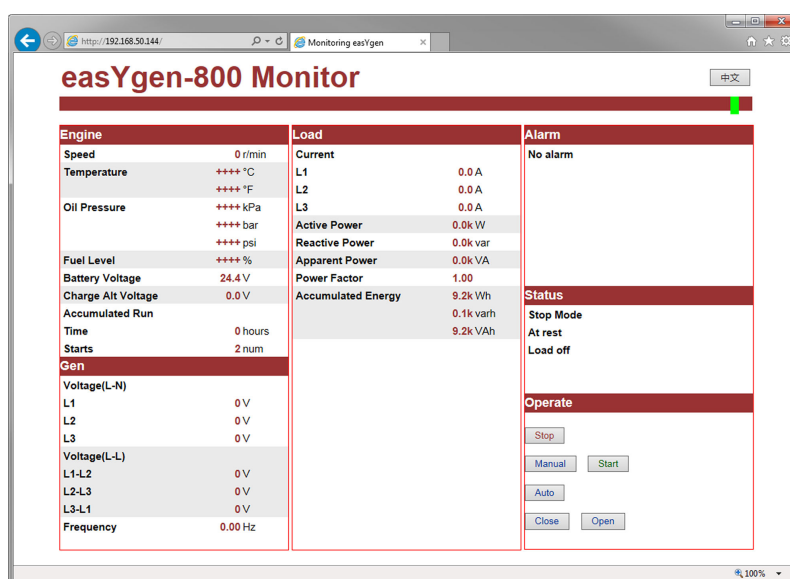

Fig. 22: Web Server mode

4.2.7 Configure Maintenance

"PARAMETER ➔ Configure maintenance"

Configuration

Parameters > Configure Maintenance

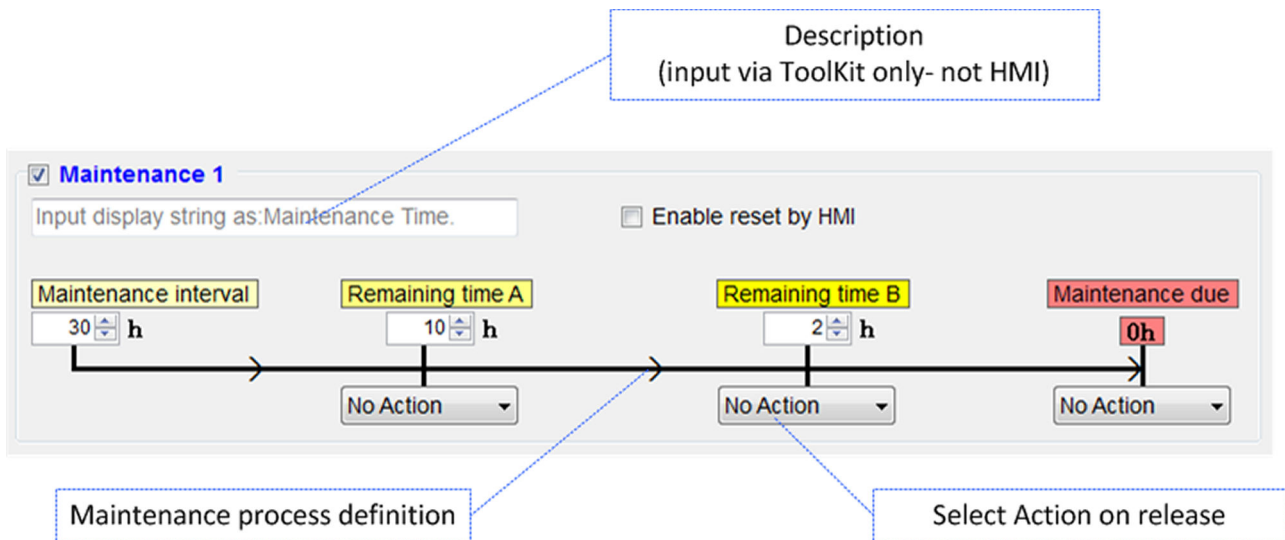

Fig. 23: Schedule Maintenance

Items	Parameters	Defaults	Description
Notes For Maintenance {x} = 1 to 3:			
Maintenance {x}	enabled/disabled	disabled	Notes "enabled": The following related settings will be taken into account
Description	Text field for 20 letters	((empty))	Customer specific sensor name
Enable reset by HMI	enabled/disabled	disabled	Notes "disabled": Reset via HMI is blocked
Maintenance interval	0 to 30000 h	10 h	
Remaining time A	0 to 30000 h	10 h	A
Select Action A	No Action Warn Shutdown Indication	No Action	
Remaining time B	0 to 30000 h	2 h	B
Select Action B	No Action Warn Shutdown Indication	No Action	
Maintenance due	Display current time		Overall
Select Action	No Action Warn Shutdown Indication	No Action	

4.2.8 Configure Counters

"PARAMETER → Configure counters"

Items	Parameters	Defaults	Description
Engine running hours			
Time	0 to 65534 hours	0 hours	Preset value
	0 to 59 min	0 min	Preset value
	Set (push button)		PUSH: Preset time is written to the connected easYgen
Start counter	0 to 65534	0	Preset value: Number of starts
	Set (push button)		PUSH: Preset number of starts is written to the connected easYgen
Current module	Display of device's values		Updated with pushing one of the Set buttons above
Total run time			Total engine run time
Total start times			Total number of starts
Generator energy			
kW	0 to 9999999.9 kW	0.0 kW	
	Set (push button)		PUSH: Preset kW value is written to the connected easYgen
kvar	0 to 9999999.9 kvar	0.0 kvar	
	Set (push button)		PUSH: Preset kvar value is written to the connected easYgen
kVA	0 to 9999999.9 kVA	0.0 kVA	
	Set (push button)		PUSH: Preset kVA value is written to the connected easYgen
Current module	Display of device's values		Displaying the device's values
kW			Each updated with pushing the related Set button (above)
Kvar			
kVA			
Total A			
Time	0 to 65534 hours	0 hours	Preset value
	0 to 59 min	0 min	Preset value
	Set (push button)		PUSH: Preset time is written to the connected easYgen
Start counter	0 to 65534	0	Preset value: Number of starts
	Set (push button)		PUSH: Preset number of starts is written to the connected easYgen
A	Display of device's values		Updated with pushing one of the Set buttons above
Total run time			Total engine run time
Total start times			Total number of starts
kW	0 to 9999999.9 kW	0.0 kW	Electric energy consumed
	Set (push button)		PUSH: Preset kW value is written to the connected easYgen
Total B			
Time	0 to 65534 hours	0 hours	Preset value
	0 to 59 min	0 min	Preset value
	Set (push button)		PUSH: Preset time is written to the connected easYgen
Start counter	0 to 65534	0	Preset value: Number of starts

Configuration

Parameters > Configure Language / Clock

Items	Parameters	Defaults	Description
	Set (push button)		PUSH: Preset number of starts is written to the connected easYgen
B	Display of device's values		Updated with pushing one of the Set buttons above
Total run time	Total engine run time		
Total start times	Total number of starts		
kW	0 to 9999999.9 kW	0.0 kW	Electric energy consumed
	Set (push button)		PUSH: Preset kW value is written to the connected easYgen

4.2.9 Configure Switchable Parameter Set

*"PARAMETER → Configure switchable parameter sets
→ Alternative set 1 to 3"*

Items	Parameters	Defaults	Description
Enable	enabled/disabled	disabled	Notes "enabled": The following related settings will be taken into account
Generator			
Generator voltage measuring	0: 3 Phase, 4 Wire (3Ph4W) 1: 3 Phase, 3 Wire (3Ph3W) 2: 2 Phase, 3 Wire (2Ph3W) 3: Single Phase, 2 Wire (1Ph2W)	0: 3 Phase, 4 Wire (3Ph4W)	
Generator rated voltage	(30 to 30000) V	230 V	
Generator rated frequency	10.0 to 85.0 Hz	50.0 Hz	
Generator rated current	5 to 6000 A	500 A	
Generator rated active power	0 to 6000 kW	276 kW	
Engine rated speed	0 to 6000 r/min	1500 r/min	

4.2.10 Configure Language / Clock

"PARAMETER → Configure language / clock"

Items	Parameters	Defaults	Description
Language	Simplified Chinese	English	With "Other" the customer specific (loaded) language (file) will be used for HMI display. Notes To upload a customer specific language file, see ToolKit-SC menu "Language pack"
	English		
	Other		
Date/Time			

Items	Parameters	Defaults	Description
Set value			
Date	Push icon	(current date)	Calendar sub module will be opened: DD.MM.YYYY
Time	Time display	(current time)	Time sub module enable comfortable setting time value: hh:mm:ss
Set	Push button		Write value to the easYgen device
Use PC time	Push button		Write PC time to the easYgen device
Current module	Date (YYYY-MM-DD)	(actual value)	Display device's value
	Time (hh:mm:ss)		

4.2.11 Configure System Management

"PARAMETER → Configure system management"

Items	Parameters	Defaults	Description
Configure system management			
Device name 1	Text field for 10 letters	((empty))	Customer specific device name
Device name 2	Text field for 10 letters	((empty))	Customer specific additional/2nd device name
Password	enabled/disabled	disabled	Enabled: <ul style="list-style-type: none"> Type in new password "eye symbol": switch between visible number and placeholder stars
	0 to 9999	0500	Factory setting for write access from ToolKit-Sc to the easYgen
Startup in mode	Stop mode Manual mode Auto mode	Stop mode	

4.2.12 Configure HMI

"PARAMETER → Configure HMI"

Items	Parameters	Defaults	Description
Mute buzzer	enabled/disabled	disabled	Disabled: No acoustic signal with alarm/warning
Activate status bar color	enabled/disabled	disabled	HMI only: Use a contrast background color of information line area at the bottom of the display?

Configuration

Parameters > Configure HMI

Items	Parameters	Defaults	Description
Set display color	HMI device display color combinations	13 F(Black)/ B(White)	<p>Display color scheme offers combinations of "F" Font color and "B" Background color to be selected:</p> <p>F (color of font and drawing) / B (color of background)</p> <p>The color combinations use the following :</p> <ul style="list-style-type: none"> ■ Black ■ White ■ B = Blue ■ G = Green ■ R = Red ■ B+G or G+B = light blue / turquoise ■ R+B = (together:) Violet ■ R+G = (together:) Yellow
Activate start-up logo	enabled/disabled	enabled	Enable or disable start-up logo during start-up.
Start-up logo duration	0.0 to 20.0 s	3.0 s	Duration the user page picture is visible during device start-up.
Set start-up logo	Push button		Push: Opens sub menu to select a picture file (480 x 27 pixels black/white) and transfer it into the device.

4.3 Selectable Inputs/Outputs/Sensors

4.3.1 Programmable Sensors

Selection

Sensor	Description	Remark
Temperature Sensor	0 Not used 1 Custom Res Curve 2 Reserved 3 VDO 4 CURTIS 5 VOLVO-EC 6 DATCON 7 SGX 8 SGD 9 SGH 10 PT100 11 SUSUKI 12 PRO 13 to 15 Reserved	Defined resistance range is (0 to 6) KΩ. Default is "7 SGX sensor".
Pressure Sensor	0 Not used 1 Custom Res Curve 2 Reserved 3 VDO 10 Bar 4 CURTIS 5 VOLVO-EC 6 DATCON 10 Bar 7 SGX 8 SGD 9 SGH 10 VDO 5 Bar 11 DATCON 5 Bar 12 DATCON 7 Bar 13 SUSUKI 14 PRO 15 Reserved	Defined resistance range is (0 to 6) KΩ. Default is "7 SGX sensor".
Fuel Level Sensor	0 Not used 1 Custom Res Curve 2 Reserved 3 SGD 4 SGH 5 to 15 Reserved	Defined resistance range is (0 to 6) KΩ. Default is "4 SGH sensor".

Configuration

Selectable Inputs/Outputs/Se... > Programmable Inputs



Configuration/Setting

When reselect sensors, the sensor curve will be transferred into the standard value. For example, if temperature sensor is SGX (120°C resistor type), its sensor curve is SGX (120°C resistor type); if select the SGD (120°C resistor type), the temperature sensor curve is SGD curve.

If there is a difference between standard sensor curve and used sensor, user can adjust it in "curve type".

When input the sensor curve values, X value (resistor) must be in sequence from small to large, otherwise, mistake occurs.

If select sensor type as "None", sensor curve is not working.

If corresponding sensor has alarm switch only, user must set this sensor as "None", otherwise, maybe there is shutdown or warning.

4.3.2 Programmable Inputs



The programmable inputs are all active, if connected to ground (B-)

Each input needs an alarm type and a release condition definition:

Alarm type	description
Indication	indicate only NO warning or shutdown
Warning	warn only NO shutdown
Shutdown	alarm and shutdown immediately
Trip and stop	alarm generator unloads shutdown after hi-speed cooling
Trip	alarm generator unloads NO shutdown

Release Condition	Description
Never	input inactive
Always	input is active all the time

Release Condition	Description
From crank	detecting as soon as start
From safety on	detecting after safety on run delay

No.	Type	Description
0	User defined	This type offers the following sub selections: <ul style="list-style-type: none"> ■ (Adjust to logic) ■ (Define alarm type) ■ (Release condition) ■ Input delay ■ (Description)
1	-	Reserved
2	Mute alarm buzzer	Can prohibit "Horn" output when input is active
3	Ext. acknowledge	Can reset shutdown alarm and trip alarm when input is active
4	Enable 60Hz ECU	Use for CANBUS engine and it is 60 Hz when input is active
5	Lamp test	All LED indicators are illuminating when input is active
6	Lock keypad	All buttons in panel is inactive except and there is in the left of first row in LCD when input is active
7	-	Reserved
8	Idle mode	Under voltage/frequency/speed protection is inactive
9	Inhibit auto stop	In Auto mode, during generator normal running, when input is active, inhibit generator shutdown automatically
10	Inhibit auto start	In Auto mode, inhibit generator start automatically when input is active
11	Inhibit scheduled run	In Auto mode, inhibit scheduled run genset when input is active
12	-	Reserved
13	GCB closed	Connect generator loading switch's Aux. Point
14	Inhibit GCB to close	Prohibit genset switch on when input is active
15	-	Reserved
16	-	Reserved
17	Operation mode AUTO lock	When input is active, controller enters into Auto mode; all the keys except are inactive
18	Operation mode AUTO inhibit	When input is active, controller won't work under Auto mode. key and simulate auto key input does not work
19	Activate backlight	The LCD backlight will illuminated when the input is active
20	Activate internal buzzer	Controller buzzer will peal when the input is active
21	Override shutdown alarms	All shutdown alarms are prohibited except emergence stop.(Means battle mode or override mode)
22	Annunciator mode	All outputs are prohibited in this mode
23	Reset Maintenance 1	Controller will set maintenance time and date 1 as default when input is active
24	Reset Maintenance 2	Controller will set maintenance time and date 2 as default when input is active
25	Reset Maintenance 3	Controller will set maintenance time and date 3 as default when input is active
26	High temperature	Connected sensor digital input
27	Low oil pressure	Connected sensor digital input
28	Start request in AUTO	In Auto mode, when input active, genset can be started automatically and take load after genset normal running; when input inactive, genset will stop automatically

Configuration

Selectable Inputs/Outputs/Se... > Programmable Outputs

No.	Type	Description
29	Start w/o load in AUTO	In Auto mode, when input is active, genset can be started automatically and NOT take load after genset normal running; when input is inactive, genset will stop automatically
30	Start request in MANUAL	In Manual mode, when input active, genset will start automatically; when input inactive, genset will stop automatically
31	Remote Start request	External request to start engine
32	-	Reserved
33	Remote STOP button	An external button can be connected and pressed as simulate panel
34	Remote MANUAL button	An external button can be connected and pressed as simulate panel
35	-	Reserved
36	Remote AUTO button	An external button can be connected and pressed as simulate panel
37	Remote START button	An external button can be connected and pressed as simulate panel
38	Remote GCB open/close button	This is simulate G-close key when easYgen controller is applied
39	-	Reserved
40	Low coolant level	Connect with water level sensor digital input port
41	Detonation shutdown (Gas engine)	Connect with detection module warn input port
42	-	Reserved
43	-	Reserved
44	First Priority	<p>Defines priority of the device in the network</p> <p>Notes</p> <p>If two genset controllers are connected via CANBUS the controller with this input port activated is powered on and loaded first.</p> <ul style="list-style-type: none"> ■ Condition 1: both controllers in auto mode ■ Condition 2: both controllers activated discrete input "31 Remote start request" ■ Condition 3: both gensets are controlled by A & B separately <p>If "Dual Mutual Standby" function is selected, always one controller is powered on (A or B).</p>
45	-	Reserved
46	-	Reserved
47	Switchable rating 1	Alternative configuration is active when the input is active. Users can set different parameters to make it easy to select current configuration via input port.
48	Switchable rating 2	
49	Switchable rating 3	
50	Gas leakage shutdown	Connect with detection module warn input port
51	Raise speed (ECU)	Rising edge: Increase speed by one "ECU Inc. / Dec. steps"
52	Lower speed (ECU)	Rising edge: Decrease speed by one "ECU Inc. / Dec. steps"

4.3.3 Programmable Outputs

No.	Type	Description
0	Not Used	
1	Engine flag 1	For details please read Chapter 4.2.4.1.2.3.1 "Engine Flags 1 to 6" on page 45 below.
2	Engine flag 2	
3	Engine flag 3	

Selectable Inputs/Outputs/Se...> Programmable Outputs

No.	Type	Description	
4	Engine flag 4		
5	Engine flag 5		
6	Engine flag 6		
7	Logic flag 1		
8	Logic flag 2		
9	Logic flag 3		
10	Logic flag 4		
11	Logic flag 5		
12	Logic flag 6		
13	-		Reserved
14	-		Reserved
15	Gas choke on		Action while cranking. Action time is as pre-set
16	Gas ignition	Action when genset starting, and disconnect when engine stopped	
17	Air flap	Action when over speed shutdown and emergence stop. It can close the air inflow to stop the engine as soon as possible	
18	Horn	Action when warning, shutdown, trips. Can be connected annunciator externally. When "alarm mute" configurable input port is active, it can remove the alarm.	
19	Ventilation louver	Action when genset is cranking and disconnect when genset stopped completely	
20	Fuel pump control	It is controlled by fuel pump of level sensor's limited threshold.	
21	Heater control	It is controlled by heating of temperature sensor's limited threshold	
22	Cooler control	It is controlled by cooler of temperature sensor's limited threshold	
23	Oil pre-supply	Action from "crank on" to "safety on"	
24	Generator excitation	Output in start period. If there is no generator frequency during normal running, it outputs for 2 seconds again	
25	Pre-lubrication	Actions in period of pre-heating to safety run	
26	Remote control bit	This port is controlled by communication (PC)	
27	GSM power enable	Power for GSM module (GSM module is reset when GSM communication failed)	
28	Open CB	Opening a breaker is requested	
29	Close GCB	Control generator to take load	
30	Open GCB	Control generator to off load	
31	-	Reserved	
32	-	Reserved	
33	Starter	Engine start request	
34	Fuel / Gas	Action when genset is cranking and disconnect when stopped completely	
35	Idle control	Used for engine which has idles. Close before starting and open in warming up delay; Close during stopping idle mode and open when stop is completed.	
36	Raise speed	Action in warming up delay	
37	Lower speed	Action between the period from "stop idle" to "failed to stop"	
38	Stop solenoid	Used for engines with ETS electromagnet. Close when stop idle is over and open when pre-set "Stop time of engine" is over	

Configuration

Selectable Inputs/Outputs/Se... > Programmable Outputs

No.	Type	Description
39	Pulse ECU to idle speed	Active 0.1s when controller enters into stop idle, used for control part of ECU dropping to idle speed
40	Stop ECU	Used for ECU engine and control its stop
41	Activate ECU power	Used for ECU engine and control its power
42	Pulse ECU to rated speed	Active 0.1s when controller enters into warming up delay; used for control part of ECU raising to normal speed
43	Generator started	Close when detects a successful start signal
44	Generator volt./freq. OK	Action when generator is normal
45	Generator running	Action in period of generator is normal running to hi-speed cooling Notes "This input was activated only when controller is in both "Normal Running" and "High Speed cooling"
46	-	Reserved
47	-	Reserved
48	Centralized alarm	Action when genset common warning, common shutdown, common trips alarm
49	Centralized trip and stop alarm	Action when common trip and stop alarm
50	Centralized shutdown alarm	Action when common shutdown alarm
51	Centralized trip alarm	Action when common trips alarm
52	Centralized warning alarm	Action in common warning alarm
53	Reserved	
54	Battery overvoltage	Action when battery's over voltage warning alarm
55	Battery undervoltage	Action when battery's low voltage warning alarm
56	Charge alternator failure	Action when charge failure warning alarms
57	-	Reserved
58	-	Reserved
59	-	Reserved
60	ECU warning alarm	Indicate ECU sends a warning signal
61	ECU shutdown alarm	Indicate ECU sends a shutdown signal
62	ECU communication failure	Indicate controller not communicates with ECU
63	-	Reserved
64	-	Reserved
65	-	Reserved
66	-	Reserved
67	-	Reserved
68	-	Reserved
69	Discrete input 1 active	Action when input port 1 is active
70	Discrete input 2 active	Action when input port 2 is active
71	Discrete input 3 active	Action when input port 3 is active
72	Discrete input 4 active	Action when input port 4 is active
73	Discrete input 5 active	Action when input port 5 is active
74	Discrete input 6 active	Action when input port 6 is active
75	Discrete input 7 active	Action when input port 7 is active

Selectable Inputs/Outputs/Se...> Programmable Outputs

No.	Type	Description
76	Discrete input 8 active	Action when input port 8 is active
77 to 80	-	Reserved
81	Ext. discrete input 1 active	Action when extend digital input port 1 is active
82	Ext. discrete input 2 active	Action when extend digital input port 2 is active
83	Ext. discrete input 3 active	Action when extend digital input port 3 is active
84	Ext. discrete input 4 active	Action when extend digital input port 4 is active
85	Ext. discrete input 5 active	Action when extend digital input port 5 is active
86	Ext. discrete input 6 active	Action when extend digital input port 6 is active
87	Ext. discrete input 7 active	Action when extend digital input port 7 is active
88	Ext. discrete input 8 active	Action when extend digital input port 8 is active
89	Ext. discrete input 9 active	Action when extend digital input port 9 is active
90	Ext. discrete input 10 active	Action when extend digital input port 10 is active
91	Ext. discrete input 11 active	Action when extend digital input port 11 is active
92	Ext. discrete input 12 active	Action when extend digital input port 12 is active
93	Ext. discrete input 13 active	Action when extend digital input port 13 is active
94	Ext. discrete input 14 active	Action when extend digital input port 14 is active
95	Ext. discrete input 15 active	Action when extend digital input port 15 is active
96	Ext. discrete input 16 active	Action when extend digital input port 16 is active
97	-	Reserved
98	-	Reserved
99	Emergency Stop	Action when emergency stop alarm
100	Start fail	Action when failed start alarm
101	Engine stop malfunction	Action when failed stop alarm
102	Underspeed warning	Action when under speed alarm
103	Underspeed shutdown	Action when under speed shuts down
104	Overspeed warning	Action when over speed warns
105	Overspeed shutdown	Action when over speed shutdown alarm
106	-	Reserved
107	-	Reserved
108	-	Reserved
109	Gen. overfrequency warning	Action when generator over frequency warns
110	Gen. overfrequency shutdown	Action when generator over frequency shutdown alarm
111	Gen. overvoltage warning	Action when generator over voltage warns
112	Gen. overvoltage shutdown	Action when generator over voltage shutdown
113	Gen. underfrequency warning	Action when generator low frequency warns
114	Gen. underfrequency shutdown	Action when generator low frequency shutdown
115	Gen. undervoltage warning	Action when generator low voltage warns
116	Gen. undervoltage shutdown	Action when generator low voltage shutdown
117	Gen. voltage asymmetry	Action when generator loss phase
118	Gen. phase rotation mismatch	Action when generator reverse phase
119	-	Reserved
120	Overload	Action when controller detects generator have over power

Configuration

Status Menu > HMI Status Screens

No.	Type	Description
121	-	Reserved
122	Reverse power	Action when controller detects generator have reverse power
123	Overcurrent	Action when over current
124 to 138	-	Reserved
139	High temperature warning	Action when hi-temperature warns
140	Low temperature warning	Action when low temperature warns
141	High temperature shutdown	Action when hi-temperature shutdown alarm
142	-	Reserved
143	Low oil pressure warning	Action when low oil pressure warns
144	Low oil pressure shutdown	Action when low oil pressure shutdown
145	Oil pressure sensor wire break	Action when oil pressure sensor is open circuit
146	-	Reserved
147	Fuel level low warning	Action when controller has low oil level alarm
148	-	Reserved
149	-	Reserved
150	Analog input 4 High limit warning	Status message
151	Analog input 4 Low limit warning	Status message
152	Analog input 4 High limit shutdown	Status message
153	Analog input 4 Low limit shutdown	Status message
154	Analog input 5 High limit warning	Status message
155	Analog input 5 Low limit warning	Status message
156	Analog input 5 High limit shutdown	Status message
157	Analog input 5 Low limit shutdown	Status message
158 to 229	-	Reserved
230	Operation mode STOP	Action in stop mode
231	Operation mode MAN	Action in Manual mode
232	-	Reserved
233	Operation mode AUTO	Action in Auto mode
234	GCB closed	Status message
235 to 299	-	Reserved

4.4 Status Menu

General notes

Both HMI and ToolKit-SC offer status information.

4.4.1 HMI Status Screens

HMI comes with status screens:

- Status
- Engine
- Gen(erator)
- Load
- Alarm

- Log
- Others
- About
- ... and the home screen
in a loop

4.4.2 ToolKit-SC Status Screens

General notes

ToolKit-SC enables dedicated access to status information summarized into the following screens:

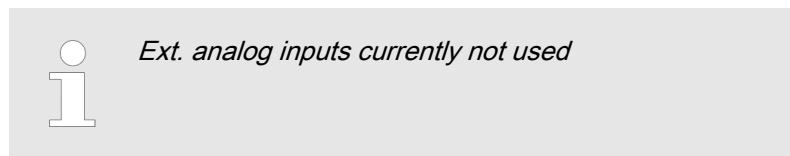
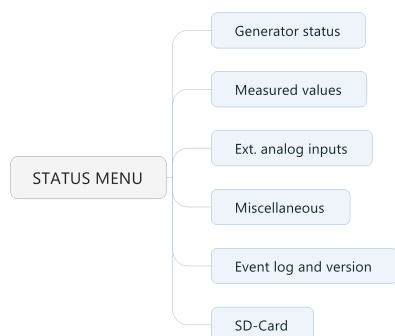

Fig. 24: easYgen-x800 status screens

Generator Status

"PARAMETER → STATUS MENU → Generator status"

Items	Parameters	Description
Engine/Sensor info	Engine speed, Engine temp, Oil pressure, Fuel level, Battery volt, Charger volt	
More info	Fuel temp, Inlet temp, Exhaust temp, Coolant pressure, Fuel pressure, Turbo pressure, Total fuel consume, Coolant level, Oil temp	Selection of ECU data via J1939.
Status and delay	Gen status, Breaker status, Remote start	
Alarms		Display of current alarms and warnings
Digital inputs	1 start request in AUTO, 2 High temperature, 3 Low oil pressure, 4 User defined, 5 User-defined, 6 User-defined, 7 Lamp test, 8 User defined, Emergency stop	
Accumulation	Active power (kW), Reactive power (kvar), Apparent power (kVA)	
Digital output	1 Engine flag 1, 2 Idle control, 3 Close GCB, 4 -, 5 Stop solenoid, 6 Centralized alarm Fuel relay, Start relay	
Status	Stop mode, Manual mode, Test mode, Auto mode, Gen available, Gen closed, Alarm indicator, Running indicator	
Current date and time	Date (yyyy-mm-dd), Time (hh:mm:ss)	

Configuration

Status Menu > ToolKit-SC Status Screens

Measured Values

"PARAMETER → STATUS MENU → Measured values"

Items	Parameters	Description
Electricity quantity		
Mains	-/-	
Generator	L1, L2, L3, L1-2, L2-3, L3-1, L1Phase, L2Phase, L3Phase, Frequency	
Current (A)	L1, L2, L3	
Active power (kW)	L1, L2, L3, Total	
Reactive power (kvar)	L1, L2, L3, Total	
Apparent power (kVA)	L1, L2, L3, Total	
Power factor	L1, L2, L3, Avg	

Ext. Discrete Inputs/Outputs

"PARAMETER → STATUS MENU → Ext. discrete inputs/outputs"

Items	Parameters	Description
Ext. discrete inputs 1-16		
Input {X}	(contact open/closed)	{X}: 1 or 16
Ext. discrete outputs 1-16		
Output {Y}	(Hi/Low)	{Y}: 1 or 16

Miscellaneous

"PARAMETER → STATUS MENU → Miscellaneous"

Items	Parameters	Description
Total A	Run time, Starts, Total energy	
Total B	Run time, Starts, Total energy	
SD card	Status, Total capacity, Remain capacity	
Earth fault current	Percent	
Next maintenance time	Maintenance 1 to 3	

Event Log and Version

"PARAMETER → STATUS MENU → Event log and version"

Items	Parameters	Description
Module Info	Model, Hardware Version, Software Version, Issue Date	
Event log	<p>Fixed view of: No., Event type</p> <p>Columns "move behind" visible part of the screen: Event Item, Date, Time, ((Mains control is not supported by this model, so all "Mains" values are "0":) <i>Mains Uab (V) / Ubc (V) / Uca (V), Mains Ua (V), Mains Ub (V), Mains Uc (V), Mains f (Hz),</i> Gens Uab (V) ..., Gens Ua (V) ..., Gens f(Hz), Current Ia (A) ..., Power (kW), Speed (r/min), Temp. (°C), Press. (kPa), Volt. (V)</p>	Event log report table. Showing the 99 latest events or - with SD card - the content of the .DAT file(s)
	<p>Read log</p> <p>Clear</p> <p>Export to Txt</p>	Push buttons to manage logged data (internal or SD card)

SD-Card

"PARAMETER → STATUS MENU → SD-Card"

The SD-Card stores the same information as "Event log and version" but on the inserted SD card in a .DAT file format.

Items	Description
Read all log	Event table is filled with all stored data
((number selection boxes)) Read log	Read and displayed events can be pre-selected by min and max number e.g. for better overview
Export to Txt	List of current (selected) events can be saved as .TXT file

4.4.3 Configure For Using Accessories



For configuration see [Chapter 4.2 "Parameters"](#) on page 38.

Configuration

Status Menu > Configure For Using Access... > Digital Input Module WWDIN...

4.4.3.1 Digital Input Module WWDIN16

General notes

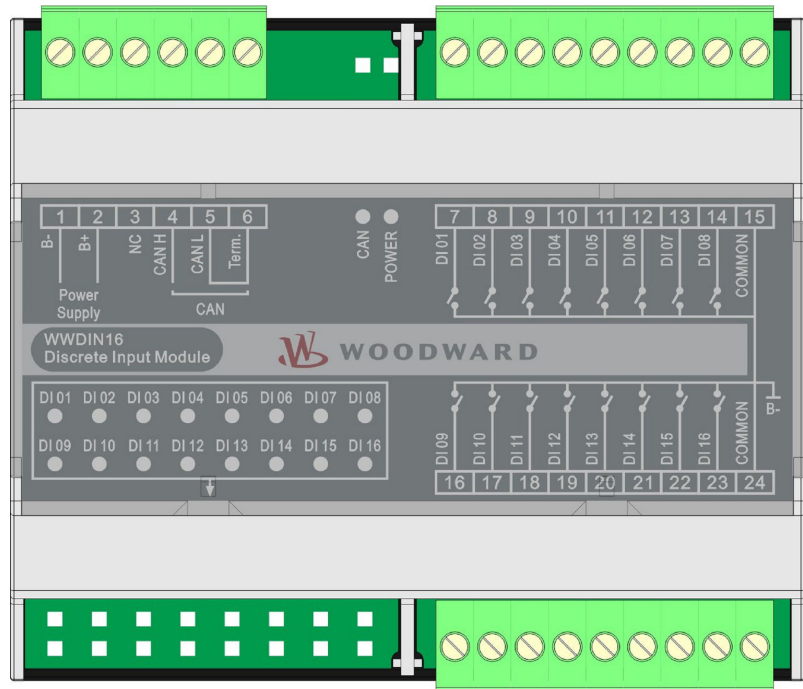

Fig. 25: WWDIN16

Woodward Digital Input Module (WWDIN16) is an expansion module which has 16 auxiliary digital input channels. WWDIN16 data is transmitted to the easYgen via CANBUS.

4.4.3.1.1 Technical Data

Parameter	Contents
Working Voltage	8.0 to 35.0 V _{DC} , continuous power supply
Power Consumption	<2 W
Programmable relay output 1-16	7 A Connected to common output port
Dimensions	107.6 mm x 89.7 mm x 60.7 mm
Working conditions	Temperature : -25 to +70 °C Humidity : 20 to 93 %RH
Storage conditions	Temperature : -25 to 70 °C
Weight	0.60 kg

Table 1: Technical Data

4.4.3.1.2 Warnings

General notes

Warnings are not shutdown alarms and do not affect the operation of the genset. When WWDIN16 module is enabled and detects the warning signal, the controller will initiate a warning alarm and the corresponding alarm information will be displayed on LCD. Warning types are as follows

No.	Items	DET Range	Description
1	WWDIN16 Auxiliary Input 1 to 16	User-defined.	<p>When the controller detects that the WWDIN16 auxiliary input 1 to 16 alarm signal and the action set as "Warning", it will initiate a warning alarm and the corresponding alarm information will be displayed on LCD.</p> <p>Each string of WWDIN16 input can be defined by users, such as input port 1 defined as "High Temp Warning", when it is active, corresponding alarm information will displayed on LCD.</p>

4.4.3.1.3 Shutdown Alarm

General notes

When WWDIN16 module is enabled and detects the shutdown signal, the easYgen controller will initiate a shutdown alarm and the corresponding alarm information will be displayed on LCD. Shutdown alarms are as follows:

No.	Items	DET Range	Description
1	WWDIN16 Auxiliary Input 1 to 16	User-defined.	<p>When the controller detects that the WWDIN16 auxiliary input 1 to 16 alarm signal and the action set as "Shutdown", it will initiate a shutdown alarm and the corresponding alarm information will be displayed on LCD.</p> <p>Each string of WWDIN16 input can be defined by users, such as input port 1 defined as "High Temp Shutdown", when it is active, corresponding alarm information will displayed on LCD.</p>



The types of shutdown alarm of auxiliary input port are effective only when users configure them. Only emergency shutdown and overspeed shutdown work when the controller is in override mode.

4.4.3.1.4 Configuration

General notes

Users can set the parameters of WWDIN16 module via easYgen.

Pressing and holding ENTER button  for more than 3 seconds will enter the configuration menu, which allows users to set all WWDIN16 parameters, as follows:

Configuration

Status Menu > Configure For Using Access... > Digital Input Module WWDIN...



Pressing  can exit setting directly during setting.

Items	Range	Default Values	Remarks
1. Input 1 Set	0 to 50	0 : Not used	WWDIN16 setting
2. Input 1 Type	0 to 1	0 : Close to activate	WWDIN16 setting
3. Input 2 Set	0 to 50	0 : Not used	WWDIN16 setting
4. Input 2 Type	0 to 1	0 : Close to activate	WWDIN16 setting
5. Input 3 Set	0 to 50	0 : Not used	WWDIN16 setting
6. Input 3 Type	0 to 1	0 : Close to activate	WWDIN16 setting
7. Input 4 Set	0 to 50	0 : Not used	WWDIN16 setting
8. Input 4 Type	0 to 1	0 : Close to activate	WWDIN16 setting
9. Input 5 Set	0 to 50	0 : Not used	WWDIN16 setting
10. Input 5 Type	0 to 1	0 : Close to activate	WWDIN16 setting
11. Input 6 Set	0 to 50	0 : Not used	WWDIN16 setting
12. Input 6 Type	0 to 1	0 : Close to activate	WWDIN16 setting
13. Input 7 Set	0 to 50	0 : Not used	WWDIN16 setting
14. Input 7 Type	0 to 1	0 : Close to activate	WWDIN16 setting
15. Input 8 Set	0 to 50	0 : Not used	WWDIN16 setting
16. Input 8 Type	0 to 1	0 : Close to activate	WWDIN16 setting
17. Input 9 Set	0 to 50	0 : Not used	WWDIN16 setting
18. Input 9 Type	0 to 1	0 : Close to activate	WWDIN16 setting
19. Input 10 Set	0 to 50	0 : Not used	WWDIN16 setting
20. Input 10 Type	0 to 1	0 : Close to activate	WWDIN16 setting
21. Input 11 Set	0 to 50	0 : Not used	WWDIN16 setting
22. Input 11 Type	0 to 1	0 : Close to activate	WWDIN16 setting
23. Input 12 Set	0 to 50	0 : Not used	WWDIN16 setting
24. Input 12 Type	0 to 1	0 : Close to activate	WWDIN16 setting
25. Input 13 Set	0 to 50	0 : Not used	WWDIN16 setting
26. Input 13 Type	0 to 1	0 : Close to activate	WWDIN16 setting
27. Input 14 Set	0 to 50	0 : Not used	WWDIN16 setting
28. Input 14 Type	0 to 1	0 : Close to activate	WWDIN16 setting
29. Input 15 Set	0 to 50	0 : Not used	WWDIN16 setting
30. Input 15 Type	0 to 1	0 : Close to activate	WWDIN16 setting
31. Input 16 Set	0 to 50	0 : Not used	WWDIN16 setting
32. Input 16 Type	0 to 1	0 : Close to activate	WWDIN16 setting

Table 2: Input Settings (easYgen)

4.4.3.1.5 Input Port Configuration

Digital Inputs

No.	Items	Contents	Description
1	Function set	0 to 50	More details please refer to Function Setting
2	Active Type	0 to 1	0 : Close to activate 1 : Open to activate
3	Effective Range	0 to 3	0 : From Safety on 1 : From Crank 2 : Always 3 : Never
4	Effective Action	0 to 2	0 : Warn 1 : Shutdown 2 : Indication
5	Input Delay	0.0 to 20.0 s	
6	Display string	User-defined names of input port	Input port names can be edited via PC software only.

Table 3: Digital Inputs

Function Setting

No.	Contents	Description
0	Not used	
1	User-defined	Users configured input port settings
2	Alarm Mute	Can prohibit "Horn" output when input is active
3	Reset alarm	Can reset all alarms when input is active
4	Raise Speed	The generator will increase speed by GOV when the input is active
5	Drop Speed	The generator will decrease speed by GOV when the input is active
6	Reserved	
7	Reserved	
8	Lamp test	All LED indicators are illuminating when input is active
9	Local mode	Places generator into its local mode
10	Remote mode	Places generator into its remote mode
11	Remote start	Automatically starts the generator in remote mode when the input is active. Only the active shutdown input will be able to stop the generator. (Inch or hold the button for more than 1s)
12	Remote stop	Stops the running generator in remote mode when the input is active
13	Remote start/stop	Automatically starts the generator in remote mode; the generator will shut down when this input is deactivated
14	Pre-lubricate	If output is set as pre-lubrication output, the relay disconnects after the set pre-lubrication delay
15	Override mode	Places the generator into its override mode; in override mode only over-speed shutdown and emergency shutdown will stop the engine
16	Emergency stop	The controller shuts down the engine immediately and records occurrence time

Configuration

Status Menu > Configure For Using Access... > Digital Input Module WWDIN...

No.	Contents	Description
17	Panel lock	All buttons in panel is inactive except for and is shown on the right of the first line in LCD status page
18	Reserved	
19	Power Change	Transfers from main battery to standby battery
20	Raise Speed Aux. input	Raise speed relay will disconnect when the input is active
21	Reserved	
22	Drop Speed Aux. input	Drop speed relay will disconnect when the input is active
23	Water Heating feedback	The feedback signal of water heating output; the screen displays Water Heating feedback when the input is active
24	Pre-lube feedback	The feedback signal of Pre-lube output; the screen displays Pre-lube feedback when the input is active
25	Charging feedback	The feedback signal of Charging output; the screen displays Charging feedback when the input is active
26	Reserved	
27	Reserved	
28	Quick start	Cranking will start directly (without preheating) when the input is active
29	Reserved	
30	60Hz Select	Frequency selection of ECU engine
31	Turning Chain	Start inhibition when the input is active
32	Cylinder Scavenging	Starter relay outputs when the input is active
33	Reserved	
34	Self-inspection	Inspect each warning point without crank genset when the input is active
35 to 50	Reserved	

Table 4: Function Settings

4.4.3.1.6 Installation

General notes

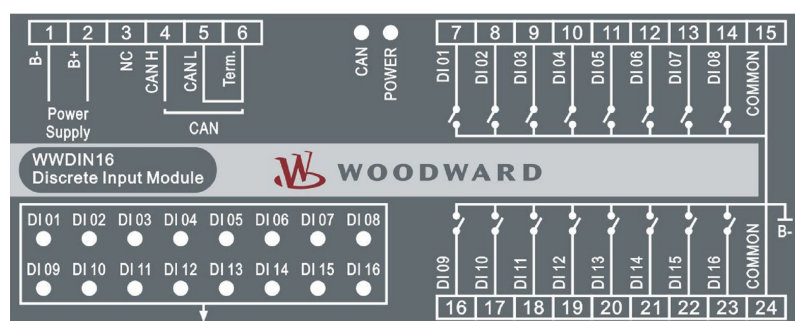

Fig. 26: WWDIN16 terminals

No.	Function	Cable Size	Description
1	DC input B-	2.5 mm ²	DC power supply negative input.
2	DC input B+	2.5 mm ²	DC power supply positive input.
3	SCR (CANBUS)	0.5 mm ²	Connect CANbus communication port to expansion CAN port of the easYgen.
4	CAN(H) (CANBUS)	0.5 mm ²	

Status Menu> Configure For Using Access...> Digital Input Module WWDIN...

No.	Function	Cable Size	Description
5	CAN(L) (CANBUS)	0.5 mm ²	120-Ω-shielding is implemented (one wire end grounded). If needed, make terminal 5, 6 short circuits.
6	120Ω	0.5 mm ²	
7	DIN1	1.0 mm ²	Digital input
8	DIN2	1.0 mm ²	Digital input
9	DIN3	1.0 mm ²	Digital input
10	DIN4	1.0 mm ²	Digital input
11	DIN5	1.0 mm ²	Digital input
12	DIN6	1.0 mm ²	Digital input
13	DIN7	1.0 mm ²	Digital input
14	DIN8	1.0 mm ²	Digital input
15	COM(B-)	1.0 mm ²	Connect to B- is allowed.
16	DIN9	1.0 mm ²	Digital input
17	DIN10	1.0 mm ²	Digital input
18	DIN 11	1.0 mm ²	Digital input
19	DIN 12	1.0 mm ²	Digital input
20	DIN 13	1.0 mm ²	Digital input
21	DIN 14	1.0 mm ²	Digital input
22	DIN 15	1.0 mm ²	Digital input
23	DIN 16	1.0 mm ²	Digital input
24	COM(B-)	1.0 mm ²	Connect to B- is allowed.
LED Indicator	INPUT STATUS		Active input(s): corresponding LED(s) illuminated

Table 5: Terminals

Configuration

Status Menu > Configure For Using Access... > Digital Input Module WWDIN...

4.4.3.1.7 Typical Application

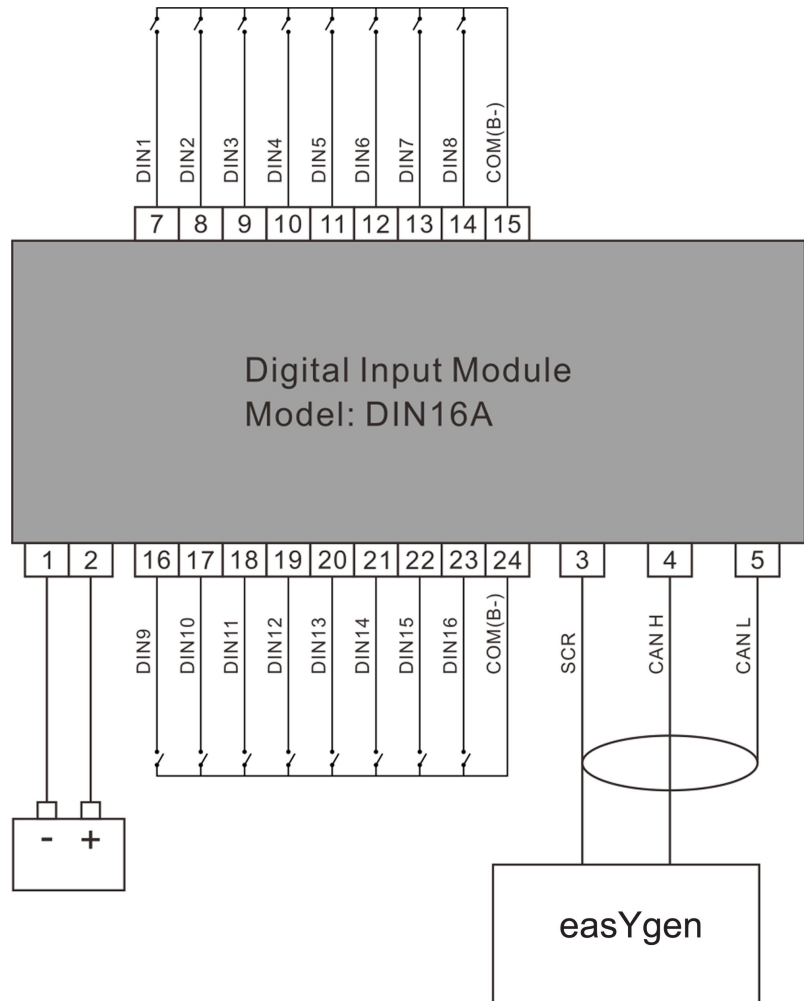

Fig. 27: Typical application

4.4.3.1.8 DIN Rail Mounting Dimensions

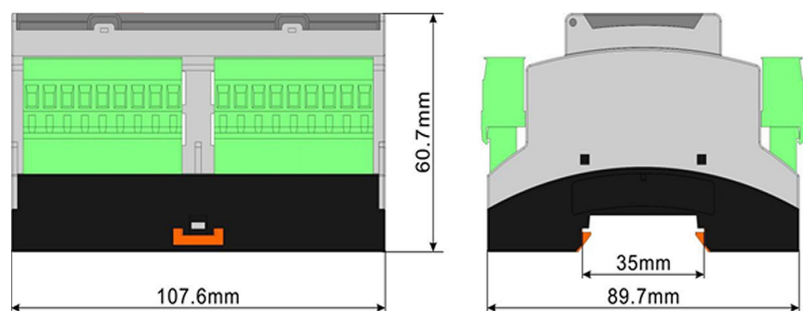

Fig. 28: WWDIN16A dimensions

4.4.3.1.9 Troubleshooting

Problem	Possible Solution
No power indication	Check starting batteries Check controller connection wiring
CANbus communication failure	Check wiring
Auxiliary input alarm	Check wiring Check if input polarities configuration is correct

Table 6: Troubleshooting

4.4.3.2 Digital Output Module WWDOOUT16

General notes

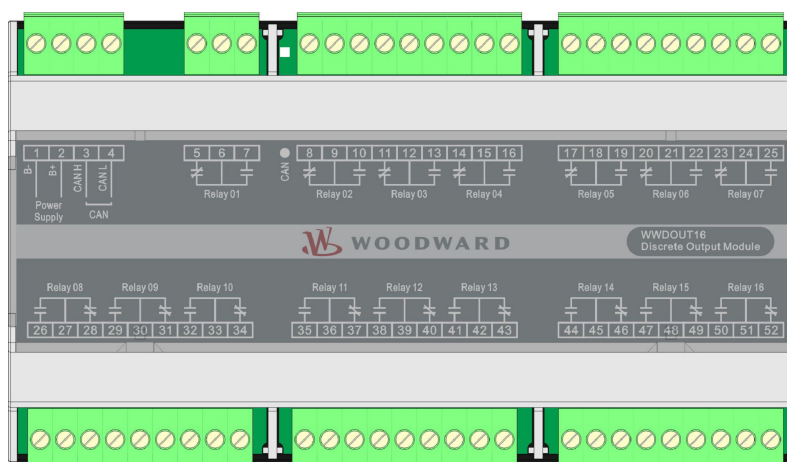

Fig. 29: WWDOOUT16B

Woodward Digital Output Module (WWDOOUT16) is an expansion module which has 16 auxiliary digital output channels. WWDOOUT16 data is transmitted via CANBUS from easYgen to WWDOOUT16 output module.

4.4.3.2.1 Technical Data

Parameter	Contents
Working Voltage	8.0 to 35.0 V _{DC} , continuous power supply
Power Consumption	<5 W
Programmable relay output 1-16	7 A Connected to common output port
Dimensions	161.6 mm x 89.7 mm x 60.7 mm
Working conditions	Temperature : -25 to +70 °C Humidity : 20 to 93%RH
Storage conditions	Temperature : -25 to 70 °C
Weight	0.60 kg

Table 7: Technical Data

Configuration

Status Menu > Configure For Using Access... > Digital Output Module WWDO...

4.4.3.2.2 Configuration

General notes

The parameters of WWDOOUT16 module can be set via easYgen. Configuration is stored in the internal storage of the easYgen.

Parameter	Range	default value	Remarks
1. Output 1 Set	All settings come from the easYgen connected with WWDOOUT16. Changing the WWDOOUT16 hardware has no influence to parameter settings.	0: Not used	Configurable output port Function
2. Output 1 Type		0: Normally open	Configurable output type.
3. Output 2 Set		0: Not used	Configurable output port Function
4. Output 2 Type		0: Normally open	Configurable output type.
5. Output 3 Set		0: Not used	Configurable output port Function
6. Output 3 Type		0: Normally open	Configurable output type.
7. Output 4 Set		0: Not used	Configurable output port Function
8. Output 4 Type		0: Normally open	Configurable output type.
9. Output 5 Set		0: Not used	Configurable output port Function
10. Output 5 Type		0: Normally open	Configurable output type.
11. Output 6 Set		0: Not used	Configurable output port Function
12. Output 6 Type		0: Normally open	Configurable output type.
13. Output 7 Set		0: Not used	Configurable output port Function
14. Output 7 Type		0: Normally open	Configurable output type.
15. Output 8 Set		0: Not used	Configurable output port Function
16. Output 8 Type		0: Normally open	Configurable output type.
17. Output 9 Set		0: Not used	Configurable output port Function
18. Output 9 Type		0: Normally open	Configurable output type.
19. Output 10 Set		0: Not used	Configurable output port Function
20. Output 10 Type		0: Normally open	Configurable output type.
21. Output 11 Set		0: Not used	Configurable output port Function
22. Output 11 Type		0: Normally open	Configurable output type.
23. Output 12 Set		0: Not used	Configurable output port Function
24. Output 12 Type		0: Normally open	Configurable output type.
25. Output 13 Set		0: Not used	Configurable output port Function
26. Output 13 Type		0: Normally open	Configurable output type.
27. Output 14 Set		0: Not used	Configurable output port Function
28. Output 14 Type		0: Normally open	Configurable output type.
29. Output 15 Set		0: Not used	Configurable output port Function
30. Output 15 Type		0: Normally open	Configurable output type.
31. Output 16 Set		0: Not used	Configurable output port Function
32. Output 16 Type		0: Normally open	Configurable output type.

Table 8: Output Settings (easYgen)

4.4.3.2.3 Installation

General notes

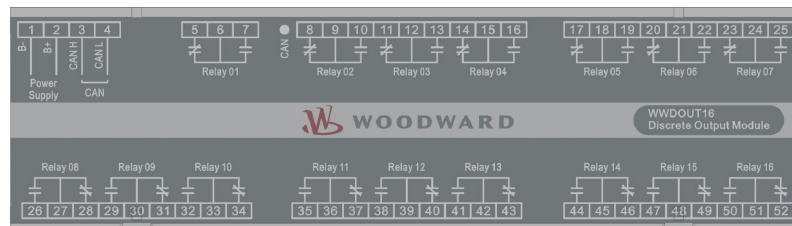

Fig. 30: WWDOOUT16 terminals

No.	Function	Cable Size	Description
1.	DC input B-	2.5 mm ²	DC power supply negative input.
2.	DC input B+	2.5 mm ²	DC power supply positive input.
3.	CAN(H) (CANBUS)	0.5 mm ²	Connect CANbus communication port to expansion CAN port of the easYgen. 120-Ω-shielding is recommended (one wire end grounded) .
4.	CAN(L) (CANBUS)		
5.	Aux. output port 1	1.0 mm ²	Voltage free output; rated current is 7 A.
6.			
7.			
8.	Aux. output port 2	1.0 mm ²	Voltage free output; rated current is 7 A.
9.			
10.			
11.	Aux. output port 3	1.0 mm ²	Voltage free output; rated current is 7 A.
12.			
13.			
14.	Aux. output port 4	1.0 mm ²	Voltage free output; rated current is 7 A.
15.			
16.			
17.	Aux. output port 5	1.0 mm ²	Voltage free output; rated current is 7 A.
18.			
19.			
20.	Aux. output port 6	1.0 mm ²	Voltage free output; rated current is 7 A.
21.			
22.			
23.	Aux. output port 7	1.0 mm ²	Voltage free output; rated current is 7 A.
24.			
25.			
26.	Aux. output port 8	1.0 mm ²	Voltage free output; rated current is 7 A.
27.			
28.			
29.	Aux. output port 9	1.0 mm ²	Voltage free output; rated current is 7 A.
30.			
31.			
32.	Aux. output port 10	1.0 mm ²	Voltage free output; rated current is 7 A.

Configuration

Status Menu > Configure For Using Access... > Digital Output Module WWDO...

No.	Function	Cable Size	Description
33.			
34.			
35.	Aux. output port 11	1.0 mm ²	Voltage free output; rated current is 7 A.
36.			
37.			
38.	Aux. output port 12	1.0mm ²	Voltage free output; rated current is 7 A.
39.			
40.			
41.	Aux. output port 13	1.0 mm ²	Voltage free output; rated current is 7 A.
42.			
43.			
44.	Aux. output port 14	1.0 mm ²	Voltage free output; rated current is 7 A.
45.			
46.			
47.	Aux. output port 15	1.0 mm ²	Voltage free output; rated current is 7 A.
48.			
49.			
50.	Aux. output port 16	1.0 mm ²	Voltage free output; rated current is 7 A.
51.			
52.			
POWER	Power indicator		Illuminating: power supply is OK
LINK	Upgrade port		Software upgrades connection port

Table 9: Terminals

4.4.3.2.4 DIN Rail Mounting

Dimensions

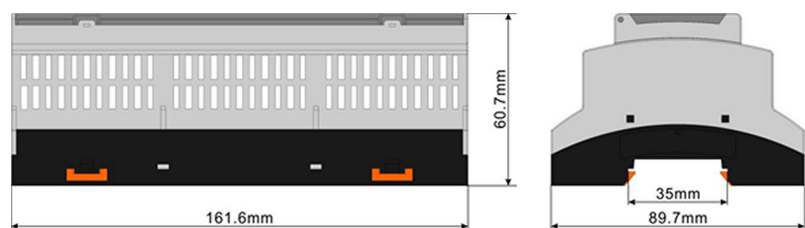

Fig. 31: WWDOOUT16 dimensions

4.4.3.2.5 Troubleshooting

Problem	Possible Solution
No power indication	Check controller connection wiring
CANbus communication failure	Check wiring
No output from output port	Check if output port settings are active

Table 10: Troubleshooting

5 Operation

5.1 Front Panel: Operating and Display Elements

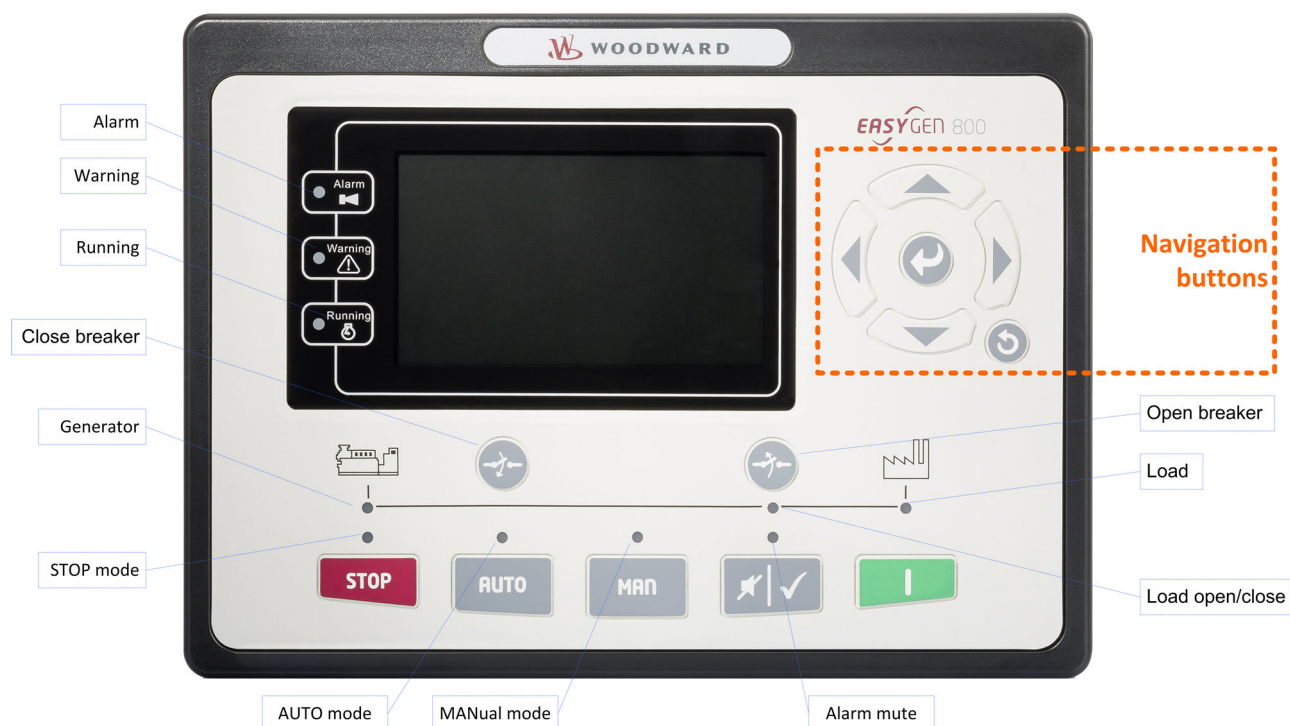















Fig. 32: easYgen-800

Icons	Keys	Description
	STOP	Auto/Manual mode: Stop running generator Stop mode: Reset alarm Lamp test (press at least 3 seconds) Notes During stopping process, press this button again to stop generator immediately.
	I (START)	MANual mode: Start genset
	MAN (Manual Mode)	Press this key and controller enters into MANual mode
	AUTO (Automatic Mode)	Press this key and controller enters into AUTO mode
	Mute "Horn"/ Alarm acknowledge	Press once: Alarming sound OFF Second time pressing the button: <ul style="list-style-type: none"> ■ Alarm is acknowledged ■ Alarm LED changes from twinkling to permanently illuminated
	Close breaker	MANual mode: Switch breaker ON/Close

Operation

Front Panel: Operating and D...

Icons	Keys	Description
	Open breaker	MANual mode: Switch breaker OFF/Open
	Up/Increase	1) Screen scroll 2) Setting menu: Up cursor and increase value in
	Down/Decrease	1) Screen scroll 2) Setting menu: Down cursor and decrease value
	Left	1) Screen scroll 2) Setting menu: Left move cursor
	Right	1) Screen scroll 2) Setting menu: Right move cursor
	Set/Confirm	Select viewing area
	Exit	1) Returns to the main menu 2) In settings menu returns to the previous menu
	Warning	
	Alarm	
	Running	
	Genset	
	Load	



In MANual mode:

*Pressing **MAN** and **I** (START) simultaneously will force generator to crank. Successful start will not be judged according to crank disconnect conditions, operator will have to crank the starter motor manually; when operator decides that the engine has fired, he/she should release the button and start output will be deactivated, safety on delay will start.*

**WARNING!**

Passwords can be changed by user. Please clearly remember the password after changing. If you forget it, please contact Woodward services and send all device information of the controller page "ABOUT" for legitimation.

5.2 Warning/Alarm Signaling

The Alarm type and Warning are visualized with - combinations of - both LEDs "Alarm" and "Warning" located beside the display.

Alarm Indicator LED	Warning Indicator LED	Alarm Type
Slow flashing	Slow flashing	Warning
Fast flashing	Off	Shutdown or Trip Alarm
Fast flashing	Slow flashing	Shutdown or Trip Alarm with Warning
ON (permanently illuminated)	Off	Common Alarm, acknowledged
ON (permanently illuminated)	ON (permanently illuminated)	Shutdown or Trip Warning, Alarm acknowledged

5.2.1 Alarm Acknowledgment

General notes

The alarm acknowledge handling is valid for following alarm classes

- Warning
- Shutdown
- Trip/Stop
- Trip

Mute Horn

Any new active alarm activates the horn and is visible with the flashing "Alarm" LED.

After pressing the mute/acknowledge button the "horn" is deactivated and the "Alarm" LED changes from flashing to constant active and stays active as long as any alarm is present. An additional active alarm reactivates the horn and the "Alarm LED" starts flashing again.

Stop by alarm

The operation mode automatically changes to STOP if a stopping alarm is active ("Shutdown" or "Trip/Stop").

Acknowledge alarm

The alarm reset is done with additional (2nd time) pressing the mute/acknowledge button (Alarm LED is no longer flashing).

Operation

Operation Modes > Operation Mode STOP

5.3 Operation Modes

General notes

The easYgen offers three operation modes:

- AUTO
- MANUAL (MAN)
- STOP
- ... and an internal (non) operating phase during starting the device itself

The operation mode can be initiated - if current settings allow this function:

- directly by pressing the according button at the front panel
- directly by click on the according button at the ToolKit-SC remote screen
- via discrete inputs
- via interface

5.3.1 Operation Mode AUTO

General notes

In operation mode AUTO breakers and genset are under easYgen control. Start and stop of the engine is managed automatically together with open, close, and breaker transition.

Depending on settings and application status, AUTO control can:

- supply load by generator
- start the engine
- stop the engine

5.3.2 Operation Mode MANual

General notes

In operation mode MANual both breakers and genset are independently from each other under easYgen control.

Start and stop of the engine is managed with the same procedure as in AUTO mode but without breaker control. Breakers can be opened and closed without taking care of load or genset state!

5.3.3 Operation Mode STOP

General notes

In operation mode STOP breakers are open and engine is not running.



This is a configurable operation mode, only. This is NO emergency STOP!

5.4 START/STOP Operation

5.4.1 Start engine to supply load

The AUTO Start procedure is going through sub procedures with own timers.



The remaining time of each of the timers initiated is shown in the display.

When started via "Remote Start (off Load)" input, start procedures is the same as described below but breaker close relay is deactivated.

Operation

START/STOP Operation > Stop engine

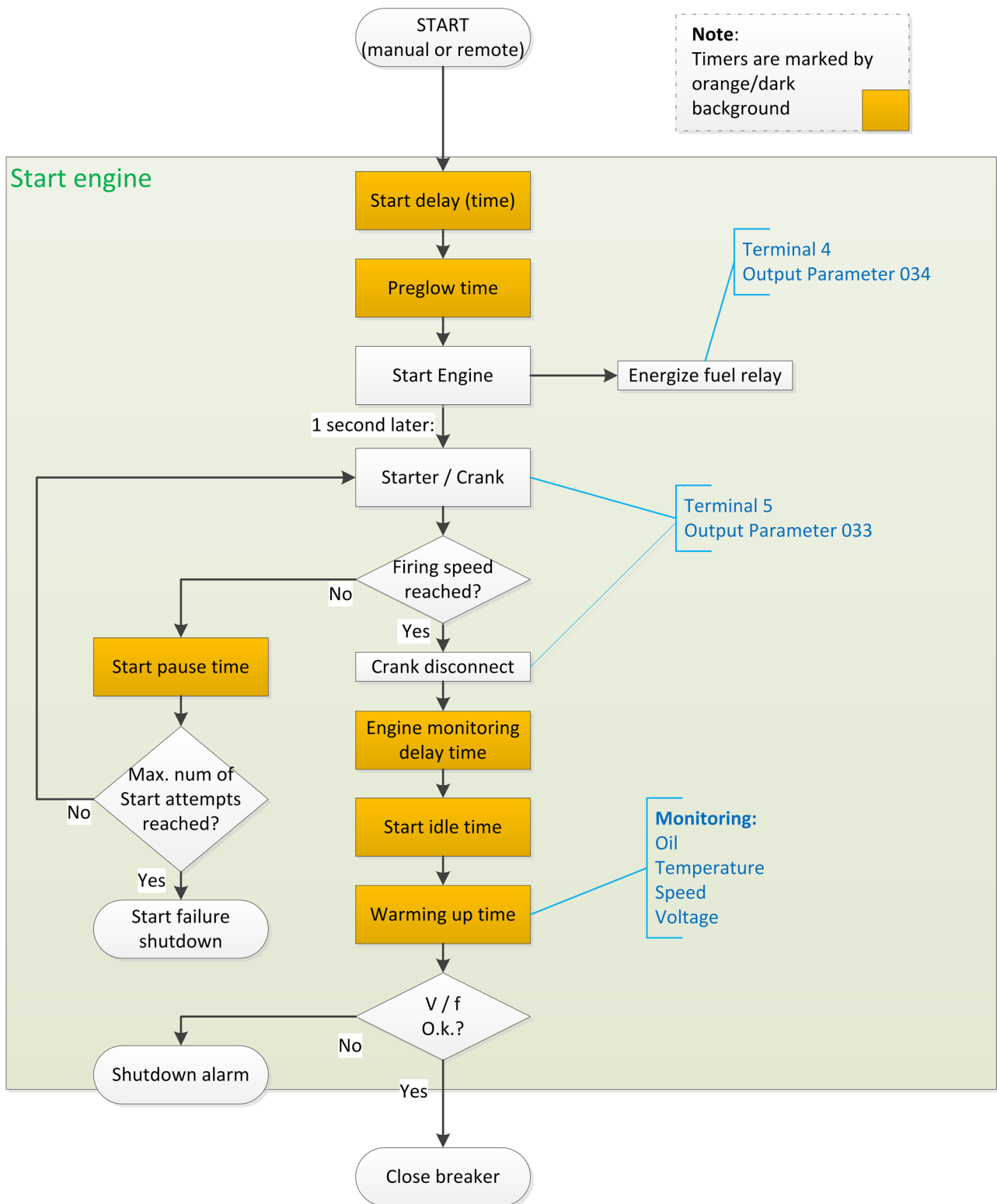

Fig. 33: Engine start procedure

5.4.2 Stop engine

The AUTO Stop procedure is going through sub procedures with own timers.



The remaining time of each of the timers initiated is shown in the display.

When started via "Remote Stop (off Load)" input, start procedures is the same as described below but breaker open relay is deactivated.

Operation

START/STOP Operation > Stop engine

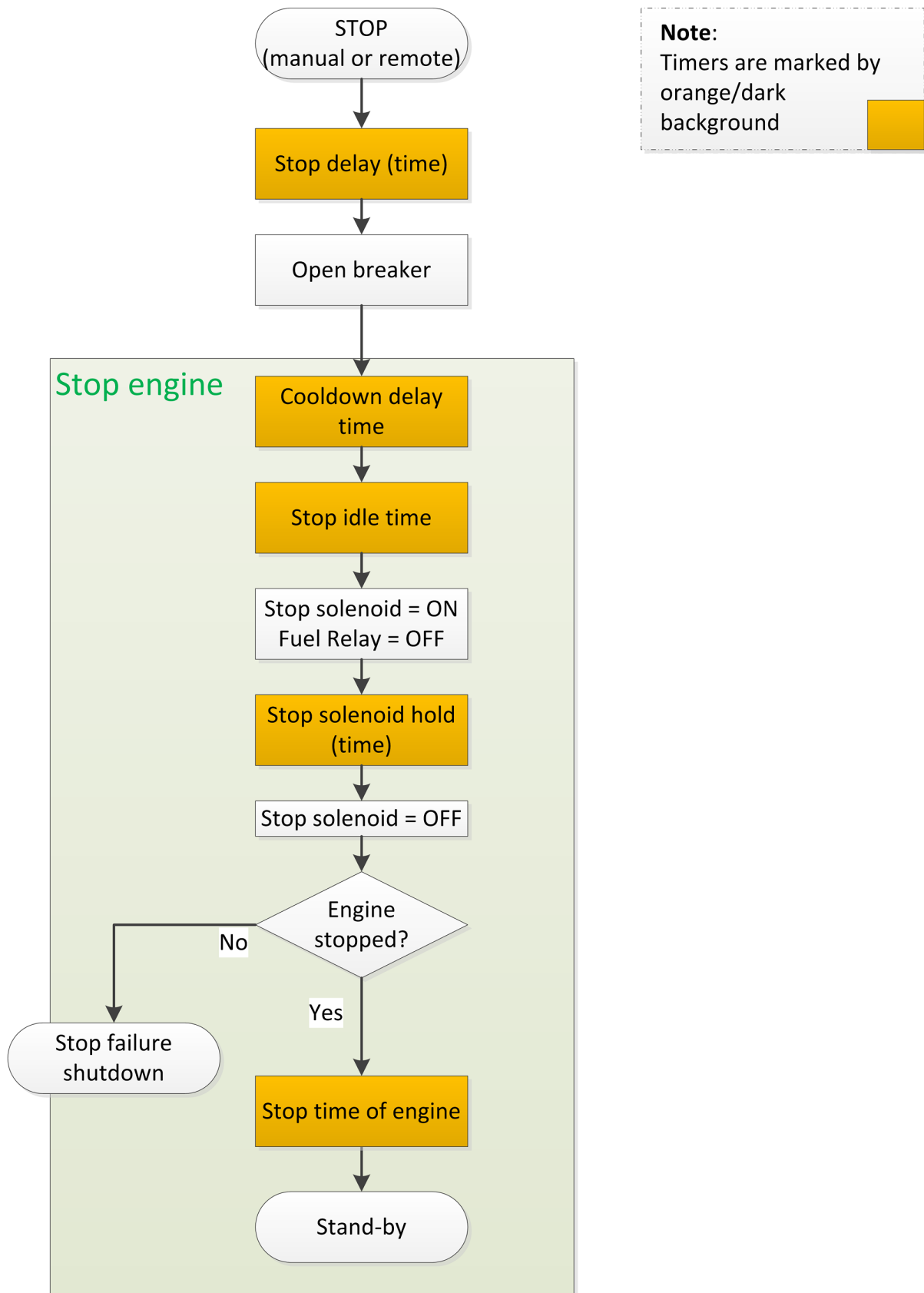



Fig. 34: Engine stop/stand-by procedure

5.4.3 MANual START/STOP



Engine control is separated from breaker management. Breaker(s) must be manually opened/closed (supply should be in normal range).

MANual Start

1. ➤ Press MAN button 
 - ⇒ the LED besides the button will illuminate to confirm the operation
2. ➤ Press START button  to start the genset as described above. With high temperature, low oil pressure, over speed and abnormal voltage during generator running, controller can protect genset to stop quickly.

MANual Stop

- Press  can stop the running generator as described above.

5.5 Transition Procedures

5.5.1 Disconnect during Cranking

There are three conditions under control to abort starting the engine:

- speed sensor
- generator frequency
- engine oil pressure

They can be used separately or in combinations.

We recommend to select all three at the same time: engine oil pressure together with speed sensor, and generator frequency. This enables to separate immediately the starter motor from engine. Additionally crank disconnect can be checked exactly.

When set as speed sensor, ensure that the number of flywheel teeth is as same as setting.



Sensor not used? Make sure it is not selected!
Otherwise "start fail" or "loss speed signal" maybe caused.



If speed sensor ("Firing speed RPM") is not selected: Rotating speed displayed in controller is calculated by generator frequency and number of poles.

If generator frequency ("Firing speed Hz") is not selected: Relative power quantity will neither be collected not displayed (e.g. water pump application).

Operation

Trouble Shooting

HMI only! In ToolKit-SC frequency, speed, and oil pressure can be enabled/disabled separately; HMI is using a table "Firing speed" instead:

No.	Setting description
0	Gen frequency
1	Speed sensor
2	Speed sensor + Gen frequency
3	Oil pressure
4	Oil pressure + Gen frequency
5	Oil pressure + Speed sensor
6	Oil pressure + Speed sensor + Gen frequency

5.6 Trouble Shooting

Symptoms	Possible Solutions
Controller no response with power.	Check starting batteries; Check controller connection wiring; Check DC fuse.
Genset shutdown	Check the water/cylinder temperature is too high or not; Check the genset AC voltage; Check DC fuse.
Controller emergency stop	Check emergence stop button is correct or not; Check whether the starting battery positive is connected with the emergency stop input; Check whether the circuit is open.
Low oil pressure alarm after crank disconnect	Check the oil pressure sensor and its connections.
High water temp. alarm after crank disconnect	Check the temperature sensor and its connections.
Shutdown Alarm in running	Check related switch and its connections according to the information on LCD; Check auxiliary input ports.
Fail to start	Check fuel oil circuit and its connections; Check starting batteries; Check speed sensor and its connections; Refer to engine manual.
Starter no response	Check starter connections; Check starting batteries.
Genset running while ATS not transfer	Check ATS; Check the connections between ATS and controllers.
RS485 communication is abnormal	Check connections; Check COM port setting is correct or not; Check RS-485 connections of A and B is reverse connect or not; Check RS485 transfer model whether damage or not; Check communication port of PC whether damage or not.
ECU communication failed	Check connections of CAN high and low polarity; Check if correctly connected of 120 Ω resistor; Check if type of engine correct; Check if connections from controller to engine and output ports setting are correct.
ECU warning or shutdown	Get information from LCD of alarm page; If there is detailed alarm, check engine according to description. If not, please refer to engine manual according to SPN alarm code.

6 Application

6.1 Commissioning

Please go to the steps below, before starting normal operation

1. ➤ Ensure all the connections are correct and wires diameter is suitable
2. ➤ Ensure that the controller DC power has fuse, controller's positive and negative connected to start battery are correct
3. ➤ Emergence stop must be connected with positive of start battery via scram button's normal close point and fuse
4. ➤ Take proper action to prevent engine to crank disconnect (e. g. Remove the connection wire of fuel valve). If checking is OK, make the start battery power on; choose manual mode and controller will executive routine
5. ➤ Set controller under manual mode, press start button **I**, genset will start. After the setting times as setting, controller will send signal of Start Fail; then press stop button **STOP** to reset controller
6. ➤ Recover the action of stop engine start (e. g. connect wire of fuel valve), press **I** again, genset will start. If everything goes well, genset will normal run after idle running (if idle run be set). During this time, please watch for engine's running situations and AC generator's voltage and frequency. If abnormal, stop genset running and check all wires connection according to this manual
7. ➤ If there is any other question, please contact your local Woodward support

Application

Commissioning

7 Interfaces and Protocols

7.1 J1939

Cummins ISB/ISBE

Terminals of controller	Connector B	Remark
Fuel relay output	39	
Start relay output	-	Connect with starter coil directly
Auxiliary output port 1	Expand 30A relay, battery voltage of 01, 07, 12, 13 is supplied by relay	ECU power Set Auxiliary output 1 as "ECU power"
Terminals of controller	9 pins connector	Remark
CAN GND	SAE J1939 shield	CAN communication shielding line(connect with ECU terminal only)
CAN(H)	SAE J1939 signal	Impedance 120 Ω connecting line is recommended.
CAN(L)	SAE J1939 return	Impedance 120 Ω connecting line is recommended.

Cummins QSL9 / CM850 engine control module

Terminals of controller	50 pins connector	Remark
Fuel relay output	39	
Start relay output	-	Connect to starter coil directly
Terminals of controller	9 pins connector	Remark
CAN GND	SAE J1939 shield-E	CAN communication shielding line(connect with ECU terminal only)
CAN(H)	SAE J1939 signal-C	Impedance 120 Ω connecting line is recommended.
CAN(L)	SAE J1939 return-D	Impedance 120 Ω connecting line is recommended.

Cummins QSM 11 (Import) / CM570 engine control module

Terminals of controller	C1 connector	Remark
Fuel relay output	5&8	Outside expand relay, when fuel output, making port 5 and port 8 of C1 be connected
Start relay output	-	Connect to starter coil directly
Terminals of controller	3 pins data link connector	Remark
CAN GND	C	CAN communication shielding line(connect with ECU terminal only)
CAN(H)	A	Impedance 120 Ω connecting line is recommended.
CAN(L)	B	Impedance 120 Ω connecting line is recommended.

Cummins QSX15-CM570

Terminals of controller	50 pins connector	Remark
Fuel relay output	38	Oil spout switch
Start relay output	-	Connect to starter coil directly
Terminals of controller	9 pins connector	Remark
CAN GND	SAE J1939 shield-E	CAN communication shielding line(connect with ECU terminal only)

Interfaces and Protocols

J1939

Terminals of controller	50 pins connector	Remark
CAN(H)	SAE J1939 signal-C	Impedance 120 Ω connecting line is recommended.
CAN(L)	SAE J1939 return-D	Impedance 120 Ω connecting line is recommended.

Cummins GCS-Modbus / QSX15, QST30, QSK23-45-60-78-... via RS-485 Modbus

Terminals of controller	D-SUB connector 06	Remark
Fuel relay output	5&8	Outside expand relay, when fuel output, making port 05 and 08 of the connector 06 be connected.
Start relay output	-	Connect to starter coil directly
Terminals of controller	D-SUB connector 06	Remark
RS485 GND	20	CAN communication shielding line(connect with ECU terminal only)
RS485+	21	Impedance 120 Ω connecting line is recommended.
RS485-	18	Impedance 120 Ω connecting line is recommended.

Cummins QSM11 / Common J1939

Terminals of controller	OEM connector of engine	Remark
Fuel relay output	38	
Start relay output	-	Connect with starter coil directly
CAN GND	-	CAN communication shielding line(connect with controller's this terminal only)
CAN(H)	46	Impedance 120 Ω connecting line is recommended.
CAN(L)	37	Impedance 120 Ω connecting line is recommended.

Cummins QSZ13 / Common J1939

Terminals of controller	OEM connector of engine	Remark
Fuel relay output	45	
Start relay output	-	Connect to starter coil directly
Auxiliary output 1	16&41	Setting to idle speed control; normally close output. Making 16 connect to 41 during high-speed running of controller via external expansion relay.
Auxiliary output 2	19&41	Setting to pulse raise speed control; normally open output. Making 19 connect with 41 for 0.1s during high-speed warming of controller via external expansion relay.
CAN GND	-	CAN communication shielding line(connect with controller's this terminal only)
CAN(H)	1	Impedance 120 Ω connecting line is recommended.
CAN(L)	21	Impedance 120 Ω connecting line is recommended.

Detroit Diesel DDEC III-IV / Common J1939

Terminals of controller	CAN port of engine	Remark
Fuel relay output	Expand 30A relay; battery voltage of ECU is supplied by relay.	
Start relay output	-	Connect to starter coil directly
CAN GND	-	CAN communication shielding line(connect with controller's terminal only)
CAN(H)	CAN(H)	Impedance 120 Ω connecting line is recommended.
CAN(L)	CAN(L)	Impedance 120 Ω connecting line is recommended.

Deutz EMR2 / Volvo EDC4

Terminals of controller	F connector	Remark
Fuel relay output	Expand 30A relay; battery voltage of terminal 14 is supplied by relay. Fuse is 16A.	
Start relay output	-	Connect to starter coil directly
-	1	Connect to battery negative pole
CAN GND	-	CAN communication shielding line(connect with controller's terminal only)
CAN(H)	12	Impedance 120 Ω connecting line is recommended.
CAN(L)	13	Impedance 120 Ω connecting line is recommended.

John Deere

Terminals of controller	21 pins connector	Remark
Fuel relay output	G, J	
Start relay output	D	
CAN GND	-	CAN communication shielding line(connect with controller's terminal only)
CAN(H)	V	Impedance 120 Ω connecting line is recommended.
CAN(L)	U	Impedance 120 Ω connecting line is recommended.

MTU ADEC (Smart Module) / ECU8

Terminals of controller	ADEC (X1port)	Remark
Fuel relay output	X1 10	X1 Terminal 9 Connected to negative of battery
Start relay output	X1 34	X1 Terminal 33 Connected to negative of battery
Terminals of controller	SMART (X4 port)	Remark
CAN GND	X4 3	CAN communication shielding line(connect to controller's this terminal only)
CAN(H)	X4 1	Impedance 120 Ω connecting line is recommended.
CAN(L)	X4 2	Impedance 120 Ω connecting line is recommended.

Interfaces and Protocols

J1939

MTU ADEC (SAM Module) / ECU7, common J1939

Terminals of controller	ADEC (X1port)	Remark
Fuel relay output	X1 43	X1 Terminal 28 Connected to negative of battery
Start relay output	X1 37	X1 Terminal 22 Connected to negative of battery
Terminals of controller	SAM (X23 port)	Remark
CAN GND	X23 3	CAN communication shielding line(connect with controller's this terminal only)
CAN(H)	X23 2	Impedance 120 Ω connecting line is recommended.
CAN(L)	X23 1	Impedance 120 Ω connecting line is recommended.

Perkins / ADEM3, ADEM4 with 2306, 2506, 2206, 1106, and 2806

Terminals of controller	Connector	Remark
Fuel relay output	110.153.334	
Start relay output	-	Connect to starter coil directly
CAN GND	-	CAN communication shielding line(connect with controller's terminal only)
CAN(H)	31	Impedance 120 Ω connecting line is recommended.
CAN(L)	32	Impedance 120 Ω connecting line is recommended.

Scania / S6 with DC9, DC12, and DC16

Terminals of controller	B1 connector	Remark
Fuel relay output	3	
Start relay output	-	Connect to starter coil directly
CAN GND	-	CAN communication shielding line(connect with controller's terminal only)
CAN(H)	9	Impedance 120 Ω connecting line is recommended.
CAN(L)	10	Impedance 120 Ω connecting line is recommended.

Volvo EDC3 / TAD1240, TAD1241, TAD1242

When this engine type is selected, preheating time should be set to at least 3 seconds.

Terminals of controller	“Stand alone” connector	Remark
Fuel relay output	H	
Start relay output	E	
Auxiliary output 1	P	ECU power Set Auxiliary output 1 as “ECU power”

Terminals of controller	“Data bus” connector	Remark
CAN GND	-	CAN communication shielding line(connect with controller’s terminal only)
CAN(H)	1	Impedance 120 Ω connecting line is recommended.
CAN(L)	2	Impedance 120 Ω connecting line is recommended.

Volvo EDC4 / TD520, TAD520 (optional), TD720, TAD720 (optional), TAD721, TAD722, and TAD732

Terminals of controller	Connector	Remark
Fuel relay output	Expand 30A relay; battery voltage of terminal 14 is supplied by relay. Fuse is 16A.	
Start relay output	-	Connect to starter coil directly
	1	Connected to negative of battery
CAN GND	-	CAN communication shielding line(connect with controller’s terminal only)
CAN(H)	12	Impedance 120 Ω connecting line is recommended.
CAN(L)	13	Impedance 120 Ω connecting line is recommended.

Volvo EMS2 / TAD734, TAD940, TAD941, TAD1640, TAD1641, and TAD1642.

When this engine type is selected, preheating time should be set to at least 3 seconds.

Terminals of controller	Engine’s CAN port	Remark
Auxiliary output 1	6	ECU stop Set Auxiliary output 1 as “ECU Stop”
Auxiliary output 2	5	ECU power Set Auxiliary output 2 as “ECU power”
	3	Negative power
	4	Positive power
CAN GND	-	CAN communication shielding line(connect with controller’s terminal only)

Interfaces and Protocols

J1939

Terminals of controller	Engine's CAN port	Remark
CAN(H)	1(Hi)	Impedance 120 Ω connecting line is recommended.
CAN(L)	2(Lo)	Impedance 120 Ω connecting line is recommended.

Yuchai / BOSCH

Terminals of controller	Engine 42 pins port	Remark
Fuel relay output	1,40	Connect to engine ignition lock
Start relay output	-	Connect to starter coil directly
CAN GND	-	CAN communication shielding line(connect with controller's this terminal only)
CAN(H)	1,35	Impedance 120 Ω connecting line is recommended.
CAN(L)	1,34	Impedance 120 Ω connecting line is recommended.
Battery	Engine 2 pins	Remark
Battery negative	1	Wire diameter 2.5mm ²
Battery positive	2	Wire diameter 2.5mm ²

Weichai / GTSC1 with BOSCH

Terminals of controller	Engine port	Remark
Fuel relay output	1,40	Connect to engine ignition lock
Start relay output	1,61	
CAN GND	-	CAN communication shielding line(connect to the controller at this end only)
CAN(H)	1,35	Impedance 120 Ω connecting line is recommended.
CAN(L)	1,34	Impedance 120 Ω connecting line is recommended.

8 Technical Specifications

Ambient

Items		Contents
Power Supply	Operating Voltage	8.0 V _{DC} to 35.0 V _{DC} , Continuous Power Supply. Reverse polarity protected
	Maximum supply voltage	Short Time 80 V (5-10 s) Long Time 50 V
	Minimum supply voltage	6.5 V
	Maximum operating current	(All relays closed, LCD bright) 380 mA (12 V); 188 mA (24 V)
	Maximum standby current	(All relays closed, LCD dimm) 90 mA (12 V); 42 mA (24 V)
Power Consumption		<4 W (standby ≤ 2 W)
Battery voltage measurement Accuracy		1% (12V/24V)
Alternator Input Range	3-Phase 4-Wire	AC15V-AC 360V (ph-N)
	3-Phase 3-Wire	AC30V - AC620V (ph-ph)
	Single-Phase 2-Wire	AC15V - AC360V (ph-N)
	2-Phase 3-Wire	AC15V - AC360V (ph-N)
AC-Measurement	Voltage Accuracy (400/480 V % rated)	Phase-phase: 100 .. 624 V : 1%; 50 .. 100 V : 1.5 % Phase-neutral: 100 .. 360 V : 1% 50 .. 100 V : 1.5 %
	Minimum frequency	Generator: 10 Hz
	Maximum frequency	Generator: 99.5 Hz
	Frequency resolution	0.1 Hz (10 .. 99 Hz)
	Frequency accuracy	±0.1 Hz
	Nominal CT secondary rating	5 A
	Overload Measurement	Max.: 10 A
	Current Accuracy	1 %
Alternator Frequency		50 Hz/60 Hz
Case Dimension		237 mm x 172 mm x 45 mm
Panel Cutout		214 mm x 160 mm
Working Conditions		Temperature: (-25 to +70) °C; Humidity: (20 to 93) %RH
Storage Condition		Temperature: (-25 to +70) °C
Protection Level against water and dust		Front: IP65 by using mounting material delivered with device Back: IP20

Technical Specifications

Items	Contents
Insulating Intensity	Apply 2.2 kV _{AC} voltage between high voltage terminal and low voltage terminal. The leakage current is not more than 3 mA within 1 min.
Net Weight	0.85 kg

Inputs/Outputs

Items	Contents	
Speed Sensor	Voltage	1.0 V to 24.0 V (RMS)
	Frequency	10,000 Hz (max.)
Excitation current D+	110 mA (12 V)	
	230 mA (24 V)	
Start Relay Output	16A DC28V supply output	
Fuel Relay Output	16A DC28V supply output	
Auxiliary Relay Output (1 .. 3)	7A DC28V supply output	
Auxiliary Relay Output (4 .. 6)	7A AC250V voltage free output	
Digital Inputs	Low level threshold	Approx. 1.3 V
	Maximum input voltage	60V
	Minimum input voltage	0 V
	High level threshold	1.7 V
CAN port (isolated)	Baud rate	250 K
Ethernet port		available
USB Port	Max. allowed cable length	1.5 m
RS485 Serial port (isolated)	Baud rate	9600
	Duplex	Half
	Max. allowed cable length	1000 m

Approvals

EMC test (CE)	Tested according to applicable EMC standards
Listings	CE marking UL6200/cUL NFPA110

Display

- 480 x 272 TFT LCD with backlight, multilingual interface (including English, Chinese or other languages) which can be chosen at the site, making commissioning convenient for factory personnel
- LCD wear-resistance and scratch resistance due to hard screen acrylic;

Housing

- Silicon panel and pushbuttons for better operation in high-temperature environment;
- Waterproof security level IP55 due to rubber seal installed between the controller enclosure and panel fascia
- Metal fixing clips enable perfect in high temperature environment
- Modular design, self-extinguishing ABS plastic enclosure, plug-gable connection terminals and embedded installation way; compact structure with easy mounting

Interfaces

- RS485 communication port enabling:
 - remote control
 - remote measuring
 - remote communication via ModBus protocol
- CANbus port and can communicate with J1939 genset:
 - Monitoring frequently-used data (such as water temperature, oil pressure, speed, fuel consumption and so on) of ECU
 - Control START, STOP, raising speed, and speed droop

Phase Configuration

- Suitable for 3-phase 4-wire, 3-phase 3-wire, single phase 2-wire, and 2-phase 3-wire systems with
 - voltage 120/240 V and
 - frequency 50/60 Hz

8.1 Measuring and Monitoring

- Measures and monitors
 - 3-phase voltage, current, power parameter, and frequency of
 - generator.

Generator

- Line voltage (U_{ab} , U_{bc} , and U_{ca})
- Phase voltage (U_a , U_b , and U_c)
- Phase sequence
- Frequency Hz
- For generator, controller has over and under voltage, over and under frequency, loss of phase, phase sequence wrong, over and reverse power, over current functions

Load

- Current I_A , I_B , I_C
- Each phase and total active power kW
- Each phase and total reactive power kvar
- Each phase and total apparent power kVA
- Each phase and average power factor PF
- Accumulate total generator power kWh, kvarh, kVAh
- Earth current A

Technical Specifications

Measuring and Monitoring

Miscellaneous

- 3 fixed analog sensors (temperature, oil pressure and fuel level)
- 2 flexible sensors can be set as temperature sensor, oil pressure sensor or level sensor
- Precision measure and display parameters about Engine:
 - Temp. (WT) °C/°F both be displayed
 - Oil pressure (OP) kPa/psi/bar all be displayed
 - Fuel level (FL) %(unit)
 - Speed (SPD) r/min (unit)
 - Battery Voltage (VB) V (unit)
 - Charger Voltage (VD) V (unit)
- Hour count (HC) can accumulate to max. 65535 hours.
- Start times can accumulate to max. 65535 times

9 Appendix

9.1 Alarms and Warnings

9.1.1 Alarm Classes

Alarm class	Visible in the display	LED and horn	Open GCB	Shut-down engine	Engine blocked until acknowledge
Warn	X	X			
	This alarm does not interrupt the unit operation. An output of the centralized alarm occurs and the command "Horn" is issued. Alarm text + flashing LED + Relay centralized alarm (horn)				
Shutdown	X	X	Immediately	Immediately	X
	With this alarm the GCB is opened immediately and the engine is stopped. Alarm text + flashing LED + Relay centralized alarm (horn) + GCB open + Engine stop.				
Trip/shut	x	x	Immediately	Cool down time	X
	With this alarm the GCB is opened immediately and the engine is stopped after cool down. Alarm text + flashing LED + Relay centralized alarm (horn) + GCB open + Cool down + Engine stop.				
Trip	X	X	X		
	With this alarm the GCB is opened immediately but does not interrupt the unit operation. Alarm text + flashing LED + Relay centralized alarm (horn) + GCB open.				
Indication	X				
	This alarm does not interrupt the unit operation. A message output without a centralized alarm occurs. Alarm text				

9.1.2 Warnings

No	Type	Description
1	Overspeed	When the controller detects that the engine speed has exceeded the pre-set value, it will initiate a warning alarm.
2	Underspeed	When the controller detects that the engine speed has fallen below the pre-set value, it will initiate a warning alarm.
3	Loss of speed signal	When the controller detects that the engine speed is 0 and the action select "Warn", it will initiate a warning alarm.
4	Gen. overfrequency	When the controller detects that the genset frequency has exceeded the pre-set value, it will initiate a warning alarm.
5	Gen. underfrequency	When the controller detects that the genset frequency has fallen below the pre-set value, it will initiate a warning alarm.
6	Gen. overvoltage	When the controller detects that the generator voltage has exceeded the pre-set value, the controller will initiate a warning alarm.
7	Gen. undervoltage	When the controller detects that the genset voltage has fallen below the pre-set value, it will initiate a warning alarm.
8	Gen. overcurrent	When the controller detects that the genset current has exceeded the pre-set value and the action select "Warn", it will initiate a warning alarm.
9	Fail to stop	After "Stop solenoid hold" delay, if genset does not stop completely, it will initiate a warning alarm.
10	Charge alternator low voltage	When the controller detects that charger voltage has fallen below the pre-set value, it will initiate a warning alarm.
11	Battery undervoltage	When the controller detects that start battery voltage has fallen below the pre-set value, it will initiate a warning alarm.
12	Battery overvoltage	When the controller detects that start battery voltage has exceeded the pre-set value, it will initiate a warning alarm.
13	Maintenance due	When count down time is 0 and the action select "Warn", it will initiate a warning alarm.

Appendix

Alarms and Warnings > Shutdown Alarms

No	Type	Description
14	Gen. reverse power	If reverse power detection is enabled, when the controller detects that the reverse power value (power is negative) has fallen below the pre-set value and the action select "Warn", it will initiate a warning alarm.
15	Overload	If over power detection is enabled, when the controller detects that the over power value (power is positive) has exceeded the pre-set value and the action select "Warn", it will initiate a warning alarm.
16	ECU warning alarm	If an error message is received from ECU via J1939, it will initiate a warning alarm.
17	Gen. loss of phase	If loss of phase detection is enabled, When controller detects the generator loss phase, it will initiate a warning alarm.
18	Gen. phase rotation mismatch	When the controller detects a phase rotation error, it will initiate a warning alarm.
19	Breaker open/close fail	When the controller detects that the breaker close or open failure occurs, and the action select "Warn", it will initiate a warning alarm.
20	Temperature sensor wire break	When the controller detects that the temperature sensor is open circuit and the action select "Warn", it will initiate a warning alarm.
21	High temperature	When the controller detects that engine temperature has exceeded the pre-set value, it will initiate a warning alarm.
22	Low temperature	When the controller detects that engine temperature has fallen below the pre-set value, it will initiate a warning alarm.
23	Oil pressure sensor wire break	When the controller detects that the oil pressure sensor is open circuit and the action select "Warn", it will initiate a warning alarm.
24	Low oil pressure	When the controller detects that the oil pressure has fallen below the pre-set value, it will initiate a warning alarm.
25	Fuel level sensor wire break	When the controller detects that the level sensor is open circuit and the action select "Warn", it will initiate a warning alarm.
26	Low fuel level	When the controller detects that the fuel level has fallen below the pre-set value, it will initiate a warning alarm.
27	Analog input 4 Wire break	When the controller detects that the flexible sensor 1 is open circuit and the action select "Warn", it will initiate a warning alarm.
28	Analog input 4 High limit	When the controller detects that the sensor 1 value has exceeded the pre-set value, it will initiate a warning alarm.
29	Analog input 4 Low limit	When the controller detects that the sensor 1 value has fallen below the pre-set value, it will initiate a warning alarm.
30	Analog input 5 Wire break	When the controller detects that the flexible sensor 2 is open circuit and the action select "Warn", it will initiate a warning alarm.
31	Analog input 5 High limit	When the controller detects that the sensor 2 value has exceeded the pre-set value, it will initiate a warning alarm.
32	Analog input 5 Low limit	When the controller detects that the sensor 2 value has fallen below the pre-set value, it will initiate a warning alarm.
33	Discrete input xyz	When digit input port is set as warning and the alarm is active, it will initiate a warning alarm.
34	GSM Communication fail	When select GSM enable but the controller couldn't detect GSM model, controller sends corresponding warning signal.
35	Ground fault	If earth fault detection is enabled, when the controller detects that the earth fault current has exceeded the pre-set value and the action select "Warn", it will initiate a warning alarm.

9.1.3 Shutdown Alarms

When controller detects shutdown alarm, it will send signal to open breaker and shuts down generator.

No	Type	Description
1	Emergency stop	When the controller detects an emergency stop alarm signal, it will initiate a shutdown alarm.
2	Overspeed	When the controller detects that the generator speed has exceeded the pre-set value, it will initiate a shutdown alarm.
3	Underspeed	When the controller detects that the generator speed has fallen below the pre-set value, it will initiate a shutdown alarm.
4	Loss of speed signal	When the controller detects that the engine speed is 0 and the action select "Shutdown", it will initiate a shutdown alarm.
5	Gen. overfrequency	When the controller detects that the genset frequency has exceeded the pre-set value, it will initiate a shutdown alarm.
6	Gen. underfrequency	When the controller detects that the genset frequency has fallen below the pre-set value, it will initiate a shutdown alarm.
7	Gen. overvoltage	When the controller detects that the generator voltage has exceeded the pre-set value, the controller will initiate a shutdown alarm.
8	Gen. undervoltage	When the controller detects that the genset voltage has fallen below the pre-set value, it will initiate a shutdown alarm.
9	Fail to stop	If the engine does not fire after the pre-set number of attempts, it will initiate a shutdown alarm.
10	Gen. overcurrent	When the controller detects that the genset current has exceeded the pre-set value and the action select "Shutdown", it will initiate a shutdown alarm.
11	Maintenance due	When count down time is 0 and the action select "Shutdown", it will initiate a shutdown alarm.
12	ECU shutdown alarm	If an error message is received from ECU via J1939, it will initiate a shutdown alarm.
13	ECU communication fail	If the module does not detect the ECU data, it will initiate a shutdown alarm.
14	Gen. reverse power	If reverse power detection is enabled, when the controller detects that the reverse power value (power is negative) has fallen below the pre-set value and the action select "Shutdown", it will initiate a shutdown alarm.
15	Overload	If over power detection is enabled, when the controller detects that the over power value (power is positive) has exceeded the pre-set value and the action select "Shutdown", it will initiate a shutdown alarm.
16	Temperature sensor wire break	When the controller detects that the temperature sensor is open circuit and the action select "Shutdown", it will initiate a shutdown alarm.
17	High temperature	When the controller detects that engine temperature has exceeded the pre-set value, it will initiate a shutdown alarm.
18	Oil pressure sensor wire break	When the controller detects that the oil pressure sensor is open circuit and the action select "Shutdown", it will initiate a shutdown alarm.
19	Low oil pressure	When the controller detects that the oil pressure has fallen below the pre-set value, it will initiate a shutdown alarm.
20	Level sensor wire break	When the controller detects that the level sensor is open circuit and the action select "Shutdown", it will initiate a shutdown alarm.
21	Analog input 4 Wire break	When the controller detects that the flexible sensor 1 is open circuit and the action select "Shutdown", it will initiate a shutdown alarm.
22	Analog input 4 High limit	When the controller detects that the sensor 1 value has exceeded the pre-set value, it will initiate a shutdown alarm.
23	Analog input 4 Low limit	When the controller detects that the sensor 1 value has fallen below the pre-set value, it will initiate a shutdown alarm.
24	Analog input 5 Wire break	When the controller detects that the flexible sensor 2 is open circuit and the action select "Shutdown", it will initiate a shutdown alarm.
25	Analog input 5 High limit	When the controller detects that the sensor 2 value has exceeded the pre-set value, it will initiate a shutdown alarm.
26	Analog input 5 Low limit	When the controller detects that the sensor 2 value has fallen below the pre-set value, it will initiate a shutdown alarm.
27	Discrete input	When digit input port is set as shutdown and the alarm is active, it will initiate a shutdown alarm.

Appendix

Alarms and Warnings > Trip Alarms

No	Type	Description
28	Ground fault	If earth fault detection is enabled, when the controller detects that the earth fault current has exceeded the pre-set value and the action select "Shutdown", it will initiate a shutdown alarm.
29	Low coolant level	Controller initiate shutdown alarm after digital input port been configured as low coolant level shutdown (is active).
30	Detonation shutdown (Gas engine)	Controller initiate shutdown alarm after digital input port been configured as detonation shutdown (is active).
31	Gas leak shutdown	Controller initiate shutdown alarm after digital input port been configured as gas leak shutdown (is active).

9.1.4 Trip and Stop Alarms

On initiation of the trip and stop condition the controller will de-energize the 'Close Generator' Output to remove the load from the generator. Once this has occurred the controller will start the Cooling delay and allow the engine to cool before shutting down the engine.

No	Type	Description
1	Gen. overcurrent	When the controller detects that the genset current has exceeded the pre-set value and the action select "Trip and Stop", it will initiate a trip and stop alarm.
2	Maintenance due	When count down time is 0 and the action select "Trip and Stop", it will initiate a trip and stop alarm.
3	Gen. reverse power	If reverse power detection is enabled, when the controller detects that the reverse power value (power is negative) has fallen below the pre-set value and the action select "Trip and Stop", it will initiate a trip and stop alarm.
4	Overload	If over power detection is enabled, when the controller detects that the over power value (power is positive) has exceeded the pre-set value and the action select "Trip and Stop", it will initiate a trip and stop alarm.
5	Discrete input	When digit input port is set as "Trip and Stop" and the alarm is active, it will initiate a trip and stop alarm.
6	Ground fault	If earth fault detection is enabled, when the controller detects that the earth fault current has exceeded the pre-set value and the action select "Trip and Stop", it will initiate a trip and stop alarm.

9.1.5 Trip Alarms

On initiation of the trip condition the controller will de-energize the 'Close Generator' Output without stop the generator.

No	Type	Description
1	Gen. overcurrent	When the controller detects that the genset current has exceeded the pre-set value and the action select "Trip", it will initiate a trip alarm.
2	Gen. reverse power	If reverse power detection is enabled, when the controller detects that the reverse power value (power is negative) has fallen below the pre-set value and the action select "Trip", it will initiate a trip alarm.
3	Overload	If over power detection is enabled, when the controller detects that the over power value (power is positive) has exceeded the pre-set value and the action select "Trip", it will initiate a trip alarm.

No	Type	Description
4	Discrete Input	When digit input port is set as "Trip" and the alarm is active, it will initiate a trip alarm.
5	Ground fault	If earth fault detection is enabled, when the controller detects that the earth fault current has exceeded the pre-set value and the action select "Trip", it will initiate a trip alarm.

9.2 Trouble Shooting

Symptoms	Possible Solutions
Controller no response with power.	Check starting batteries; Check controller connection wiring; Check DC fuse.
Genset shutdown	Check the water/cylinder temperature is too high or not; Check the genset AC voltage; Check DC fuse.
Controller emergency stop	Check emergence stop button is correct or not; Check whether the starting battery positive is connected with the emergency stop input; Check whether the circuit is open.
Low oil pressure alarm after crank disconnect	Check the oil pressure sensor and its connections.
High water temp. alarm after crank disconnect	Check the temperature sensor and its connections.
Shutdown Alarm in running	Check related switch and its connections according to the information on LCD; Check auxiliary input ports.
Fail to start	Check fuel oil circuit and its connections; Check starting batteries; Check speed sensor and its connections; Refer to engine manual.
Starter no response	Check starter connections; Check starting batteries.
Genset running while ATS not transfer	Check ATS; Check the connections between ATS and controllers.
RS485 communication is abnormal	Check connections; Check COM port setting is correct or not; Check RS-485 connections of A and B is reverse connect or not; Check RS485 transfer model whether damage or not; Check communication port of PC whether damage or not.
ECU communication failed	Check connections of CAN high and low polarity; Check if correctly connected of 120 Ω resistor; Check if type of engine correct; Check if connections from controller to engine and output ports setting are correct.
ECU warning or shutdown	Get information from LCD of alarm page; If there is detailed alarm, check engine according to description. If not, please refer to engine manual according to SPN alarm code.

9.3 Data Telegrams

General Notes

This protocol describes read and write command format of PC serial port and the definition of internal information data for the third-party to develop and use.

MODBUS communication protocol allows the module to transfer information and data effectively with PLC, RTU, SCADA system of international brands (such as, Schneider, Siemens, and Modicon), and DCS or third-party monitoring system compatible with MODBUS. The monitoring system can be set up if only adding central communication master software (such as Kingview, Intouch, FIX, Synal) basing on PC (or IPC).

9.3.1 Modbus Basics

- All communication loops should follow the master-slave mode. If so, data can be transferred between a master (e.g. PC) and 32 slaves.
- No communication can start from slaves.

Appendix

Data Telegrams > Modbus Basics > Information Frame Format

- In communication loop, all communication should be transmitted in information frame.
- If received information frame contains unknown command, no response will be given.

1) All communication loops should follow the master-slave mode. If so, data can be transferred between a master (e.g. PC) and 32 slaves. 2) No communication can start from slaves. 3) In communication loop, all communication should be transmitted in information frame. 4) If received information frame contains unknown command, no response will be given.

9.3.1.1 Data Frame Format

Communication is asynchronously transferred, using byte (data frame) as unit. Between master and slave, every transmitted data frame is 10-bit (stop bit: 1) or 11-bit (stop bit: 2) serial data stream. Data frame format is:

Start bit	1-bit
Data bit	8-bit
Parity bit	No parity
Stop bit	1-bit or 2-bit can be set.
Baud rate	9600bps

9.3.1.2 Modbus Communication Protocol

When communication command is sent to the slave, corresponding slave receives the communication command, then removes address code, and read the information. If no mistakes, it will execute commands, and sends the result back to the master. Response information includes address code, function code, data and error check code (CRC). If an error occurred in receipt of the command, it will send no information.

9.3.1.3 Information Frame Format

Initiating structure	Address code	Function code	Data field	CRC	End structure
Delay (equivalent to 4 bytes)	1 byte 8-bit	1 byte 8-bit	N bytes N*8-bit	2 bytes 16-bit	Delay (equivalent to 4 bytes)

9.3.1.4 Address Code

Address code is the first data frame (8-bit) in each transmitted information frame. Device address range is 1 to 255, this byte shows that the slave defined by users will receive the information sent by the master. Each slave has a unique address code, and responses begin with the address code. A master addresses a slave by placing the slave address in the address field of the message. When the slave sends its response, it places its own address in this address field of the response to let the master know which slave is responding.

9.3.1.5 Function Code

This is the second byte of each transmission. ModBus communication protocol defined function code as 1 to 255 (01H_hex to 0FFH_hex). This easYgen controllers use part of it. Master sends the request and the slave executes actions according to the function code. If the function code sent by slave is same as that sent by master, it means the response is active. But if the function code MSB is 1 (function code range > 127), it means there is no response or response has error. The following table shows the specific signification and operation of function code.

Function code	Definition	Operation
03_hex	Read Holding Registers	Reads the contents of holding registers
05_hex	Force Single Coil	Forces a single coil to either ON or OFF.
06_hex	Preset Single Register	Presets a value into a single holding register.

03_hex Read Holding Registers

With function code 03_hex command, the master can read the numerical registers inside the device (numerical registers contains various analog and parameter setting values). Input register values of function code 03_hex mapping data field are 16 bits (2 bytes). So, from the device reads registers values are 2 bytes. Maximum number of readable registers is 125 each time. The slave received command format is slave address, function code, data field and the CRC code. The data of data field is in double bytes with every two bytes for a group, and high byte is in advance.

05_hex Force Single Coil

Master uses this command to save a single coil data into bit registers in the device (such as ATS transfer control). The slave also uses this function code to foldback information to the master.

06_hex Preset Single register

Master uses this command to save a single register data into registers in the device. The register data in the response message are packed as two bytes per register, with the binary contents right justified within each byte. For each register, the first byte contains the high order bits and the second contains the low order bits. The slave received command format is slave address, function code, data field and the CRC code.

Appendix

Data Telegrams > Modbus Basics > Error Check Code (CRC)

9.3.1.6 Data Field

Data field varies with different function codes.

Function # 03(03_hex) – Read Holding Registers

Request:		
Data sequence	1	2
Data signification	Starting address	Read registers
Byte count	2	2

Response:		
Data sequence	1	2
Data signification	Loopback byte count	N - register data
Byte count	1	N

Function # 05 (05_hex) – Force Single Coil

Request:		
Data sequence	1	2
Data signification	Coil address	Forced single coil value
Byte count	2	2

Response:		
Data sequence	1	2
Data signification	Coil address	Single coil value
Byte count	2	2

Function # 06 (06_hex) – Preset Single Register

Request:		
Data sequence	1	2
Data signification	Register address	Register value (2-byte)
Byte count	2	2

Response:		
Data sequence	1	2
Data signification	Register address	Register value (2-byte)
Byte count	2	2

9.3.1.7 Error Check Code (CRC)

The Error Check Code allows the receiving device to detect a packet that has been corrupted with transmission errors. Sometimes, the transmission information occurs imperceptible changes due to electronic noise and other interference and the CRC code ensure the error information does not work to increase the system's safety and efficiency. When the CRC is appended to the message, the low-order byte is appended first, followed by the high-order byte.



All information frame format are same:

address code, function code, data area and CRC code. The CRC field is two bytes, containing a 16-bit binary value. The CRC value is calculated by the transmitting device, which appends the CRC to the message. The receiving device recalculates a CRC during receipt of the message, and compares the calculated value to the actual value that received in the CRC field. If the two values are not equal, an error will result.

The CRC is started by first preloading a 16-bit register to all 1's. Then a process begins of applying successive 8-bit bytes of the message to the current contents of the register. Only the eight bits of data in each character are used for generating the CRC. Start and stop bits do not apply to the CRC. During generation of the CRC, each 8-bit character is exclusive OR'ed with the register contents. Then the result is shifted in the direction of the least significant bit (LSB), with a zero filled into the most significant bit (MSB) position. The LSB is extracted and examined. If the LSB was a 1, the register is then exclusive OR'ed with a preset, fixed value. If the LSB was a 0, no exclusive OR takes place. This process is repeated until eight shifts have been performed. After the last (eighth) shift, the next 8-bit byte is exclusive OR'ed with the register's current value, and the process repeats for eight more shifts as described above. The final contents of the register, after all the bytes of the message have been applied, is the CRC value.

A procedure for generating a CRC-16 is:

1. ➤ Load a 16-bit register with FFFF hex (all 1's). Call this the CRC register.
2. ➤ Exclusive OR the first 8-bit byte of the message with the low-order byte of the 16-bit CRC register, putting the result in the CRC register. Shift the CRC register one bit to the right (toward the LSB), zero-filling the MSB. Extract and examine the LSB.
3. ➤ (If the LSB was 0): Repeat Step 3 (another shift).
(If the LSB was 1): Exclusive OR the CRC register with the polynomial value A001 hex (1010 0000 0000 0001).
4. ➤ Repeat Steps 3 and 4 until 8 shifts have been performed. When this is done, a complete 8-bit byte will have been processed. Repeat Steps 2 through 5 for the next 8-bit byte of the message. Continue doing this until all bytes have been processed.
5. ➤ The final contents of the CRC register are the CRC value. Least Significant Byte first. When the 16-bit CRC (two 8-bit bytes) is transmitted in the message, the low-order byte will be transmitted first, followed by the high-order byte.



The calculating of CRC code starts from [slave address] and except for all bytes of [CRC code].

Appendix

Data Telegrams > Modbus Basics > Error Check Code (CRC)

Example: Read 3 holding registers @ Function Code 03_hex (slave address 01_hex, starting address 0026_hex)

Address	Data(Hex)
0026_hex	14
0027_hex	14
0028_hex	5

Request	Bytes	Example (Hex)
Slave address	1	01 Send to the slave 01
Function code	1	03 Read Holding Registers
Starting address	2	00 Starting address is 0026_hex 26
No. of Points	2	00 Read 3 registers (total 6 bytes) 03
CRC code	2	E4 CRC code which calculated by PC 00

Response	Bytes	Example (Hex)
Slave address	1	01 Respond to the slave 01
Function code	1	03 Read register
Read count	1	06 3 registers (total 6 bytes)
Data 1	2	00 The content of address 0026_hex 14
Data 2	2	00 The content of address 0027_hex 14
Data 3	2	00 The content of address 0028_hex 05
CRC code	2	91 CRC code which calculated by slave 71

Example: Read coil @ Function Code 05_hex (slave address 01_hex, starting address 0002_hex is addressed as 1.)

Address	Data(Hex)
0000	0
0001	1
0002	0

Request	Bytes	Example (Hex)
Slave address	1	01 Send to the slave 01
Function code	1	05 Force Single Coli
Starting address	2	FF Set coil as 1 00
Data	2	00 Read 3 registers (total 6 bytes) 03
CRC code	2	CD CRC code which calculated by PC FB

Response	Bytes	Example (Hex)
Slave address	1	01 Respond to the slave 01
Function code	1	05 Force Single Coli
Starting address	2	00 Starting address is 0000_hex 00
Data	2	FF Set coil as 1 00
CRC code	2	CD CRC code which calculated by slave FB

Appendix

Data Telegrams > Modbus Basics > Error Handling

Example: Preset register as 0002_hex @ Function Code 06_hex (slave address 01_hex, starting address 00E3_hex)

Request	Bytes	Example (Hex)
Slave address	1	01 Send to the slave 01
Function code	1	06 Preset Single Register
Starting address	2	00 Starting address is 00E3_hex E3
Data	2	00 Preset Register Data (2 bytes) 02
CRC code	2	F9 CRC code which calculated by PC FD

Response	Bytes	Example (Hex)
Slave address	1	01 Respond to the slave 01
Function code	1	06 Preset Single Register
Starting address	2	00 Starting address is 00E3_hex E3
Data	2	00 Preset Register Data (2 bytes) 02
CRC code	2	F9 CRC code which calculated by slave FD

9.3.1.8 Error Handling

General Notes

When device detected other errors except the CRC code, the slave must send information to the master. The function code MSB is 1, which means the response function code by slave should add 128 based on the function code.

The following codes show that unexpected errors have occurred. CRC error received from the master will be ignored by the device.

The frame format of error code that responds by slave is as follows (CRC excluded):

Address code	1 byte
Function code	1 byte (MSB is 1)
Error code	1 byte
CRC code	2 bytes

Error codes

01 - illegal function code

The function code received in the query is NO allowed slave action

02 - illegal data address

The data address received in the query is NO allowed slave address

03 - illegal data value

A value contained in the query data field is NO allowed slave value

9.3.2 Read Holding Registers 03_hex



If an easYgen model does not support an information or detail, value will be empty.

Address	Items	Description	Bytes Count
0	Common Alarm	1 for active (LSB)	1bit
	Common Shutdown	1 for active	1bit
	Common Alarm	1 for active	1bit
	Common Trip and Stop	1 for active	1bit
	Common Trip	1 for active	1bit
	Common ELE Trip & Common Shutdown	1 for active	1bit
	Reserved	1 for active	1bit
	Reserved	1 for active	1bit
	In Test Mode	1 for active	1bit
	In Auto Mode	1 for active	1bit
	In Manual Mode	1 for active	1bit
	In Stop Mode	1 for active	1bit
	Reserved	1 for active	1bit
	Reserved	1 for active	1bit
	Reserved	1 for active	1bit
	Reserved	1 for active (MSB)	1bit
1	Emergency Stop	1 for active	1bit
	Over Speed	1 for active	1bit
	Under Speed	1 for active	1bit
	Loss of Speed Signal	1 for active	1bit
	Over Frequency	1 for active	1bit
	Under Frequency	1 for active	1bit
	Over Voltage	1 for active	1bit
	Under Voltage	1 for active	1bit

Appendix

Data Telegrams > Read Holding Registers 03_...

Address	Items	Description	Bytes Count
	Fail to Start	1 for active	1bit
	Over Current	1 for active	1bit
	Maintenance Due	1 for active	1bit
	ECU	1 for active	1bit
	Reverse Power Shutdown	1 for active	1bit
	Over Power Shutdown	1 for active	1bit
	Aux High Temp Shutdown	1 for active	1bit
	Aux Low OP Shutdown	1 for active	1bit
2	ECU Com Fail Shutdown	1 for active	1bit
	Reserved	1 for active	1bit
	Reserved	1 for active	1bit
	Reserved	1 for active	1bit
	Reserved	1 for active	1bit
	Negative Seq Current	1 for active	1bit
	Earth Fault	1 for active	1bit
	Loss of Exciting	1 for active	1bit
	Temp Sensor Open	1 for active	1bit
	High Temp Shutdown	1 for active	1bit
	Reserved	1 for active	1bit
	Reserved	1 for active	1bit
	Pressure Sensor Open	1 for active	1bit
	Reserved	1 for active	1bit
	Low OP Shutdown	1 for active	1bit
	Reserved	1 for active	1bit
3	Level Sensor Open	1 for active	1bit
	Reserved	1 for active	1bit
	Reserved	1 for active	1bit
	Reserved	1 for active	1bit
	Flexible Sensor 1 Open	1 for active	1bit
	Flexible Sensor 1 High	1 for active	1bit
	Flexible Sensor 1 Low	1 for active	1bit
	Reserved	1 for active	1bit
	Flexible Sensor 2 Open	1 for active	1bit
	Flexible Sensor 2 High	1 for active	1bit
	Flexible Sensor 2 Low	1 for active	1bit
	Reserved	1 for active	1bit
	Reserved	1 for active	1bit
	Reserved	1 for active	1bit
	Reserved	1 for active	1bit
	Input Module2 Cylinder Temp High	1 for active	1bit
4	Input Module1 Com Fail	1 for active	1bit
	Input Module1 Venting Temp High	1 for active	1bit

Address	Items	Description	Bytes Count
	Input Module1 Sensor15 Open	1 for active	1bit
	Input Module1 Sensor15 High	1 for active	1bit
	Input Module1 Sensor15 Low	1 for active	1bit
	Input Module1 Sensor16 Open	1 for active	1bit
	Input Module1 Sensor16 High	1 for active	1bit
	Input Module1 Sensor16 Low	1 for active	1bit
	Input Module1 Sensor17 Open	1 for active	1bit
	Input Module1 Sensor17 High	1 for active	1bit
	Input Module1 Sensor17 Low		
	Input Module1 Sensor18 Open		
	Input Module1 Sensor18 High		
	Input Module1 Sensor18 Low		
	Input Module1 Sensor19 Open		
	Input Module1 Sensor19 High	1 for active	1bit
	5	Input Module1 Sensor19 Low	1 for active
Input Module1 Sensor20 Open		1 for active	1bit
Input Module1 Sensor20 High		1 for active	1bit
Input Module1 Sensor20 Low		1 for active	1bit
Input Module1 Sensor21 Open		1 for active	1bit
Input Module1 Sensor21 High			
Input Module1 Sensor21 Low			
Input Module1 Sensor22 Open			
Input Module1 Sensor22 High			
Input Module1 Sensor22 Low			
Input Module1 Sensor23 Open			
Input Module1 Sensor23 High			
Input Module1 Sensor23 Low			
Input Module1 Sensor24 Open			
Input Module1 Sensor24 High			
Input Module1 Sensor24 Low			
6	Input Module2 Com Fail		
	Input Module2 Venting Temp High		
	Input Module2Sensor15 Open		
	Input Module2 Sensor15 High		
	Input Module2 Sensor15 Low		
	Input Module2 Sensor16 Open		
	Input Module2 Sensor16 High		
	Input Module2 Sensor16 Low		
	Input Module2 Sensor17 Open		

Appendix

Data Telegrams > Read Holding Registers 03_...

Address	Items	Description	Bytes Count
	Input Module2 Sensor17 High		
	Input Module2 Sensor17 Low		
	Input Module2 Sensor18 Open		
	Input Module2 Sensor18 High		
	Input Module2 Sensor18 Low		
	Input Module2 Sensor19 Open		
	Input Module2 Sensor19 High		
7	Input Module2 Sensor19 Low		
	Input Module2 Sensor20 Open		
	Input Module2 Sensor20 High		
	Input Module2 Sensor20 Low		
	Input Module2 Sensor21 Open		
	Input Module2 Sensor21 High		
	Input Module2 Sensor21 Low		
	Input Module2 Sensor22 Open		
	Input Module2 Sensor22 High		
	Input Module2 Sensor22 Low		
	Input Module2 Sensor23 Open		
	Input Module2 Sensor23 High		
	Input Module2 Sensor23 Low		
	Input Module2 Sensor24 Open		
Input Module2 Sensor24 High			
Input Module2 Sensor24 Low			
8	Aux Input 1 Shutdown	1 for active	1bit
	Aux Input 2 Shutdown	1 for active	1bit
	Aux Input 3 Shutdown	1 for active	1bit
	Aux Input 4 Shutdown	1 for active	1bit
	Aux Input 5 Shutdown	1 for active	1bit
	Aux Input 6 Shutdown	1 for active	1bit
	Aux Input 7 Shutdown	1 for active	1bit
	Reserved	1 for active	1bit
	Reserved	1 for active	1bit
	Reserved	1 for active	1bit
	Reserved	1 for active	1bit
	Reserved	1 for active	1bit
	Reserved		1bit
	Reserved		1bit
	Reserved		1bit

Address	Items	Description	Bytes Count
	Reserved		1bit
9	Reserved		2Bytes
	Reserved		
	Reserved		
	Reserved		
	Reserved		
	Reserved		
	Reserved		
	Reserved		
	Reserved		
	Reserved		
	Reserved		
	Reserved		
	Reserved		
	Reserved		
	Reserved		
	10	Reserved	
Reserved			
Expansion Switch Input Com Fail			
Expansion Switch Output Com Fail			
Expansion Switch Input1			
Expansion Switch Input2			
Expansion Switch Input3			
Expansion Switch Input4			
Expansion Switch Input5			
Expansion Switch Input6			
Expansion Switch Input7			
Expansion Switch Input8			
Expansion Switch Input9			
Expansion Switch Input10			
Expansion Switch Input11			
Expansion Switch Input12			
11	Expansion Switch Input13		
	Expansion Switch Input14		
	Expansion Switch Input15		
	Expansion Switch Input16		

Appendix

Data Telegrams > Read Holding Registers 03_...

Address	Items	Description	Bytes Count	
	Input Module1 Cylinder Temp Difference Large			
	Input Module1 Cylinder Temp High			
	Input Module2 Cylinder Temp Difference Large			
	Input Module2 Cylinder Temp High			
	Reserved			
	Reserved			
	Reserved			
	Reserved			
	Reserved			
	Reserved			
	Reserved			
	Reserved			
12	Over Current ELE Trip	1 for active	1bit	
	Maintenance Due ELE Trip	1 for active	1bit	
	Reverse Power ELE Trip	1 for active	1bit	
	Over Power ELE Trip	1 for active	1bit	
	Input 1 ELE Trip	1 for active	1bit	
	Input 2 ELE Trip	1 for active	1bit	
	Input 3 ELE Trip	1 for active	1bit	
	Input 4 ELE Trip	1 for active	1bit	
	Input 5 ELE Trip	1 for active	1bit	
	Input 6 ELE Trip	1 for active	1bit	
	Input 7 ELE Trip	1 for active	1bit	
	Input 8 ELE Trip	1 for active	1bit	
	Reserved	1 for active	1bit	
	Reserved	1 for active	1bit	
	Expansion Switch Input Com Fail	1 for active	1bit	
	Expansion Switch Output Com Fail	1 for active	1bit	
	13	Reserved		
		Reserved		
Reserved				
Reserved				
Reserved				
Reserved				
Reserved				
Reserved				
Reserved				
Reserved				
Reserved				
Reserved				

Address	Items	Description	Bytes Count
	Reserved		
	Reserved		
	Reserved		
	Reserved		
	Reserved		
14	Reserved		
	Reserved		
	Reserved		
	Reserved		
	Reserved		
	Reserved		
	Expansion Switch Input1		
	Expansion Switch Input2		
	Expansion Switch Input3		
	Expansion Switch Input4		
	Expansion Switch Input5		
	Expansion Switch Input6		
	Expansion Switch Input7		
	Expansion Switch Input8		
Expansion Switch Input9			
Expansion Switch Input1			
15	Expansion Switch Input11		
	Expansion Switch Input12		
	Expansion Switch Input13		
	Expansion Switch Input14		
	Expansion Switch Input15		
	Expansion Switch Input16		
	Reserved		
	Reserved		
	Reserved		
	Reserved		
	Reserved		
	Reserved		
	Reserved		
	Loss of Exciting		
Earth Fault			
Negative Seq Current			

Appendix

Data Telegrams > Read Holding Registers 03_...

Address	Items	Description	Bytes Count
16	Over Current Trip	1 for active	1bit
	Maintenance Due Trip	1 for active	1bit
	Reverse Power Trip	1 for active	1bit
	Over Power Trip	1 for active	1bit
	Input 1 Trip	1 for active	1bit
	Input 2 Trip	1 for active	1bit
	Input 3 Trip	1 for active	1bit
	Input 4 Trip	1 for active	1bit
	Input 5 Trip	1 for active	1bit
	Input 6 Trip	1 for active	1bit
	Input 7 Trip	1 for active	1bit
	Input 8 Trip	1 for active	1bit
	Reserved	1 for active	1bit
	Reserved	1 for active	1bit
	Expansion Switch Input Com Fail	1 for active	1bit
	Expansion Switch Output Com Fail	1 for active	1bit
17	PLC 1		
	PLC 2		
	PLC 3		
	PLC 4		
	PLC 5		
	PLC 6		
	PLC 7		
	PLC 8		
	PLC 9		
	PLC 10		
	PLC 11		
	PLC 12		
	PLC 13		
	PLC 14		
	PLC 15		
	PLC 16		
18	PLC 17		
	PLC 18		
	PLC 19		
	PLC 20		
	Reserved		
	Reserved		
	Expansion Switch Input1		

Address	Items	Description	Bytes Count
	Expansion Switch Input2		
	Expansion Switch Input3		
	Expansion Switch Input4		
	Expansion Switch Input5		
	Expansion Switch Input6		
	Expansion Switch Input7		
	Expansion Switch Input8		
	Expansion Switch Input9		
	Expansion Switch Input1		
19	Expansion Switch Input11		2Bytes
	Expansion Switch Input12		
	Expansion Switch Input13		
	Expansion Switch Input14		
	Expansion Switch Input15		
	Expansion Switch Input16		
	Reserved		
	Reserved		
	Reserved		
	Reserved		
	Reserved		
	Reserved		
	Reserved		
	Loss of Exciting		
	Earth Fault		
Negative Seq Current			
Reserved			
20	Gen Over Speed Warn	1 for active	1bit
	Gen Under Speed Warn	1 for active	1bit
	Gen Loss Of Speed Warn	1 for active	1bit
	Gen Over Frequency Warn	1 for active	1bit
	Gen Under Frequency Warn	1 for active	1bit
	Gen Over Voltage Warn	1 for active	1bit
	Gen Under Voltage Warn	1 for active	1bit
	Gen Over Current Warn	1 for active	1bit
	Fail to Stop Warn	1 for active	1bit
	Charge Alt Fail Warn	1 for active	1bit
	Battery High Voltage Warn	1 for active	1bit
	Battery Low Voltage Warn	1 for active	1bit
	Maintenance Due Warn	1 for active	1bit
	Reverse Power Warn	1 for active	1bit

Appendix

Data Telegrams > Read Holding Registers 03_...

Address	Items	Description	Bytes Count
	Over Power Warn	1 for active	1bit
	ECU	1 for active	1bit
21	Gen Loss of Phase Warn	1 for active	1bit
	Gen Phase Seq Wrong	1 for active	1bit
	Reserved	1 for active	1bit
	Negative Seq Current	1 for active	1bit
	Earth Fault	1 for active	1bit
	Loss of Exciting	1 for active	1bit
	Reserved	1 for active	1bit
	Breaker Warn	1 for active	1bit
	Temp Sensor Open Warn	1 for active	1bit
	High Temp Warn	1 for active	1bit
	Low Temp Warn	1 for active	1bit
	Reserved	1 for active	1bit
	Pressure Sensor Open Warn	1 for active	1bit
	Reserved	1 for active	1bit
	Low OP Warn	1 for active	1bit
	Reserved	1 for active	1bit
22	Level Sensor Open	1 for active	1bit
	Reserved	1 for active	1bit
	Low Level Warn	1 for active	1bit
	Reserved	1 for active	1bit
	Flexible Sensor 1 Open Warn	1 for active	1bit
	Flexible Sensor 1 High Warn	1 for active	1bit
	Flexible Sensor 1 Low Warn	1 for active	1bit
	Reserved	1 for active	1bit
	Flexible Sensor 2 Open Warn	1 for active	1bit
	Flexible Sensor 2 High Warn	1 for active	1bit
	Flexible Sensor 2 Low Warn	1 for active	1bit
	Reserved	1 for active	1bit
	Reserved	1 for active	1bit
	Reserved	1 for active	1bit
	Reserved	1 for active	1bit
	Input Module2 Cylinder Temp High	1 for active	1bit
23	Input Module1 Com Fail		
	Input Module1 Venting Temp High		
	Input Module1 Sensor15 Open		
	Input Module1 Sensor15 High		
	Input Module1 Sensor15 Low		
	Input Module1 Sensor16 Open		
	Input Module1 Sensor16 High		

Address	Items	Description	Bytes Count
	Input Module1 Sensor16 Low		
	Input Module1 Sensor17 Open		
	Input Module1 Sensor17 High		
	Input Module1 Sensor17 Low		
	Input Module1 Sensor18 Open		
	Input Module1 Sensor18 High		
	Input Module1 Sensor18 Low		
	Input Module1 Sensor19 Open		
24	Input Module1 Sensor19 High		
	Input Module1 Sensor19 Low		
	Input Module1 Sensor20 Open		
	Input Module1 Sensor20 High		
	Input Module1 Sensor20 Low		
	Input Module1 Sensor21 Open		
	Input Module1 Sensor21 High		
	Input Module1 Sensor21 Low		
	Input Module1 Sensor22 Open		
	Input Module1 Sensor22 High		
	Input Module1 Sensor22 Low		
	Input Module1 Sensor23 Open		
	Input Module1 Sensor23 High		
	Input Module1 Sensor23 Low		
	Input Module1 Sensor24 Open		
	Input Module1 Sensor24 High		
25	Input Module1 Sensor24 Low		
	Input Module2 Com Fail		
	Input Module2 Venting Temp High		
	Input Module2Sensor15 Open		
	Input Module2 Sensor15 High		
	Input Module2 Sensor15 Low		
	Input Module2 Sensor16 Open		
	Input Module2 Sensor16 High		
	Input Module2 Sensor16 Low		
	Input Module2 Sensor17 Open		
	Input Module2 Sensor17 High		
	Input Module2 Sensor17 Low		
	Input Module2 Sensor18 Open		

Appendix

Data Telegrams > Read Holding Registers 03_...

Address	Items	Description	Bytes Count
	Input Module2 Sensor18 High		
	Input Module2 Sensor18 Low		
	Input Module2 Sensor19 Open		
26	Input Module2 Sensor19 High		
	Input Module2 Sensor19 Low		
	Input Module2 Sensor20 Open		
	Input Module2 Sensor20 High		
	Input Module2 Sensor20 Low		
	Input Module2 Sensor21 Open		
	Input Module2 Sensor21 High		
	Input Module2 Sensor21 Low		
	Input Module2 Sensor22 Open		
	Input Module2 Sensor22 High		
	Input Module2 Sensor22 Low		
	Input Module2 Sensor23 Open		
	Input Module2 Sensor23 High		
	Input Module2 Sensor23 Low		
	Input Module2 Sensor24 Open		
	Input Module2 Sensor24 High		
27	Reserved	1 for active	1bit
	Expansion Switch Input Com Fail	1 for active	1bit
	Expansion Switch Output Com Fail	1 for active	1bit
	Expansion Switch Input1	1 for active	1bit
	Expansion Switch Input2	1 for active	1bit
	Expansion Switch Input3	1 for active	1bit
	Expansion Switch Input4	1 for active	1bit
	Expansion Switch Input5	1 for active	1bit
	Expansion Switch Input6	1 for active	1bit
	Expansion Switch Input7	1 for active	1bit
	Expansion Switch Input8	1 for active	1bit
	Expansion Switch Input9	1 for active	1bit
	Expansion Switch Input10	1 for active	1bit
	Expansion Switch Input11	1 for active	1bit
Expansion Switch Input12	1 for active	1bit	
Expansion Switch Input13	1 for active	1bit	
28	Expansion Switch Input14		
	Expansion Switch Input15		
	Expansion Switch Input16		
	Reserved		

Address	Items	Description	Bytes Count	
	Reserved			
	Reserved			
	Reserved			
	Reserved			
	Reserved			
	Reserved			
	Reserved			
	Input Module1 Cylinder Temp Difference Large			
	Input Module1 Cylinder Temp High			
	Input Module2 Cylinder Temp Difference Large			
	Input Module2 Cylinder Temp High			
	Reserved			
	29	Aux Input 1 Warn	1 for active	1bit
		Aux Input 2 Warn	1 for active	1bit
Aux Input 3 Warn		1 for active	1bit	
Aux Input 4 Warn		1 for active	1bit	
Aux Input 5 Warn		1 for active	1bit	
Aux Input 6 Warn		1 for active	1bit	
Aux Input 7 Warn		1 for active	1bit	
Aux Input 8 Warn		1 for active	1bit	
Reserved			1bit	
Reserved			1bit	
Reserved			1bit	
Reserved			1bit	
Reserved			1bit	
Reserved			1bit	
Reserved		1bit		
30	Reserved		1bit	
	Reserved		1bit	
	Reserved		1bit	
	Reserved		1bit	
	Reserved		1bit	
	Reserved		1bit	
	Reserved		1bit	
	Reserved		1bit	
	Reserved		1bit	
	Reserved		1bit	
	Reserved		1bit	

Appendix

Data Telegrams > Read Holding Registers 03_...

Address	Items	Description	Bytes Count
	Reserved		1bit
	Reserved		1bit
	Reserved		1bit
	Reserved		1bit
	Reserved		1bit
	Reserved		1bit
31	Reserved		2Bytes
32	Reserved		2Bytes
33	Reserved		2Bytes
34	Reserved		2Bytes
35	Emergency Stop Input Status	1 for active	1bit
	Digital Input 1 Status	1 for active	1bit
	Digital Input 2 Status	1 for active	1bit
	Digital Input 3 Status	1 for active	1bit
	Digital Input 4 Status	1 for active	1bit
	Digital Input 5 Status	1 for active	1bit
	Digital Input 6 Status	1 for active	1bit
	Digital Input 7 Status	1 for active	1bit
	Digital Input 8 Status	1 for active	1bit
	Reserved	1 for active	1bit
	Reserved	1 for active	1bit
	Reserved	1 for active	1bit
	Reserved	1 for active	1bit
	Reserved	1 for active	1bit
Reserved	1 for active	1bit	
36	Reserved		2Bytes
37	Fuel Relay Output Status	1 for active	1bit
	Start Relay Output Status	1 for active	1bit
	Digital Output 1 Status	1 for active	1bit
	Digital Output 2 Status	1 for active	1bit
	Digital Output 3 Status	1 for active	1bit
	Digital Output 4 Status	1 for active	1bit
	Digital Output 5 Status	1 for active	1bit
	Digital Output 6 Status	1 for active	1bit
	Reserved	1 for active	1bit
	Reserved	1 for active	1bit
	Reserved	1 for active	1bit
	Reserved	1 for active	1bit
	Reserved	1 for active	1bit

Address	Items	Description	Bytes Count
	Reserved	1 for active	1bit
	Reserved	1 for active	1bit
	Reserved	1 for active	1bit
38	Reserved		2Bytes
39	Reserved		2Bytes
40	Reserved		2Bytes
41	Reserved		2Bytes
42	Reserved		2Bytes
43	Reserved	1 for active	1bit
	Reserved	1 for active	1bit
	Reserved	1 for active	1bit
	Reserved	1 for active	1bit
	Reserved	1 for active	1bit
	Reserved	1 for active	1bit
	Reserved	1 for active	1bit
	Reserved	1 for active	1bit
	Reserved	1 for active	1bit
	Reserved	1 for active	1bit
	Reserved	1 for active	1bit
	Reserved	1 for active	1bit
	Reserved	1 for active	1bit
	Reserved	1 for active	1bit
	Reserved	1 for active	1bit
44	Reserved	1 for active	1bit
	Reserved	1 for active	1bit
	Reserved	1 for active	1bit
	Reserved	1 for active	1bit
	Reserved	1 for active	1bit
	Reserved	1 for active	1bit
	Reserved	1 for active	1bit
	Reserved	1 for active	1bit
	Reserved	1 for active	1bit
	Reserved	1 for active	1bit
	Reserved	1 for active	1bit
	Reserved	1 for active	1bit
	Reserved	1 for active	1bit
	Reserved	1 for active	1bit
	Reserved	1 for active	1bit

Appendix

Data Telegrams > Read Holding Registers 03_...

Address	Items	Description	Bytes Count
45	Aux Input 1 Active	1 for active	1bit
	Aux Input 2 Active	1 for active	1bit
	Aux Input 3 Active	1 for active	1bit
	Aux Input 4 Active	1 for active	1bit
	Aux Input 5 Active	1 for active	1bit
	Aux Input 6 Active	1 for active	1bit
	Aux Input 7 Active	1 for active	1bit
	Aux Input 8 Active	1 for active	1bit
	Reserved	1 for active	1bit
	Reserved	1 for active	1bit
	Reserved	1 for active	1bit
	Reserved	1 for active	1bit
	Reserved	1 for active	1bit
	Reserved	1 for active	1bit
	Reserved	1 for active	1bit
46	Reserved		2Bytes
47	Reserved		2Bytes
48	Reserved		2Bytes
49	Reserved		2Bytes
50	Reserved		2Bytes
51	Reserved		2Bytes
52	Reserved		2Bytes
53	Reserved		2Bytes
54	Reserved		2Bytes
55	Reserved		2Bytes
56	Reserved		2Bytes
57	Reserved		2Bytes
58	Reserved		2Bytes
59	Reserved		2Bytes
60	Reserved		2Bytes
61	Reserved		2Bytes
62	Reserved		2Bytes
63	Reserved		2Bytes
64	Reserved		2Bytes
65	Reserved		2Bytes
66	Reserved		2Bytes
67	Reserved		2Bytes
68	Reserved		2Bytes

Address	Items	Description	Bytes Count
69	Reserved		2Bytes
70	Reserved		2Bytes
71	Reserved		2Bytes
72	Reserved		2Bytes
73	Reserved		2Bytes
74	Reserved		2Bytes
75	Gen UAB		2Bytes
76	Gen UBC		2Bytes
77	Gen UCA		2Bytes
78	Gen UA		2Bytes
79	Gen UB		2Bytes
80	Gen UC		2Bytes
81	Gen UA Phase	Signed	2Bytes
82	Gen UB Phase	Signed	2Bytes
83	Gen UC Phase	Signed	2Bytes
84	Gen Freq	(*10)	2Bytes
85	Reserved	Signed	2Bytes
86	Reserved	Signed (*100)	2Bytes
87	Reserved	Signed (*10)	2Bytes
88	Reserved	Signed (*10)	2Bytes
89	Reserved	Signed (*10)	2Bytes
90	Reserved	Signed (*10)	2Bytes
91	Reserved	Signed (*10)	2Bytes
92	Reserved	Signed (*10)	2Bytes
93	Reserved	Signed (*10)	2Bytes
94	Reserved		2Bytes
95	A-phase Current	(*10)	2Bytes
96	B-phase Current	(*10)	2Bytes
97	C-phase Current	(*10)	2Bytes
98	Earth Current	(*10)	2Bytes
99	Reserved		2Bytes
100	Reserved		2Bytes
101	Reserved		2Bytes
102	Reserved		2Bytes
0103 0104	A-phase Active Power	Signed (*10)	4Bytes
0105 0106	B-phase Active Power	Signed (*10)	4Bytes
0107 0108	C-phase Active Power	Signed (*10)	4Bytes
0109 0110	Total Active Power	Signed (*10)	4Bytes
0111 0112	A-phase Reactive Power	Signed (*10)	4Bytes
0113 0114	B-phase Reactive Power	Signed (*10)	4Bytes

Appendix

Data Telegrams > Read Holding Registers 03_...

Address	Items	Description	Bytes Count
0115 0116	C-phase Reactive Power	Signed (*10)	4Bytes
0117 0118	Total Reactive Power	Signed (*10)	4Bytes
0119 0120	A-phase Apparent Power	Signed (*10)	4Bytes
0121 0122	B-phase Apparent Power	Signed (*10)	4Bytes
0123 0124	C-phase Apparent Power	Signed (*10)	4Bytes
0125 0126	Total Apparent Power	Signed (*10)	4Bytes
127	A-phase Power Factor	Signed (*100)	2Bytes
128	B-phase Power Factor	Signed (*100)	2Bytes
129	C-phase Power Factor	Signed (*100)	2Bytes
130	Average Power Factor	Signed (*100)	2Bytes
131	Reserved		2Bytes
132	Reserved		2Bytes
133	Reserved		2Bytes
134	Reserved		2Bytes
135	Reserved		2Bytes
136	Reserved		2Bytes
137	Reserved		2Bytes
138	Reserved		2Bytes
139	Reserved		2Bytes
140	Reserved		2Bytes
141	Engine Speed		2Bytes
142	Battery Voltage	(*10)	2Bytes
143	Charger Voltage	(*10)	2Bytes
144	GSM Signal strength		2Bytes
145	Reserved		2Bytes
146	Reserved		2Bytes
147	Reserved		2Bytes
148	Temp Sensor Resistance Value	Unsigned (*10)	2Bytes
149	Temp Sensor Value	Signed	2Bytes
150	Pressure Sensor Resistance Value	Unsigned (*10)	2Bytes
151	Pressure Sensor Value	Signed	2Bytes
152	Level Sensor Resistance Value	Unsigned (*10)	2Bytes
153	Level Sensor Value	Signed	2Bytes
154	Config Sensor 1 Resistance Value	Unsigned (*10)	2Bytes
155	Config Sensor 1 Value	Signed	2Bytes
156	Config Sensor 2 Resistance Value	Unsigned (*10)	2Bytes
157	Config Sensor 2 Value	Signed	2Bytes
158	Reserved		2Bytes
159	Reserved		2Bytes

Address	Items	Description	Bytes Count
160	Reserved		2Bytes
161	Reserved		2Bytes
162	Coolant Level	Signed; These items are -Reserved if ECU is NOT used.	2Bytes
163	Oil Temperature		2Bytes
164	Coolant Pressure		2Bytes
165	Fuel Pressure		2Bytes
166	Fuel Temperature		2Bytes
167	Inlet Temperature		2Bytes
168	Exhaust Temperature		2Bytes
169	Turbo Pressure		2Bytes
170	Fuel Consumption		2Bytes
171	Total Fuel Consumption		4Bytes
172			
173	Reserved		2Bytes
174	Reserved		2Bytes
175	Reserved		2Bytes
176	Reserved		2Bytes
177	Reserved		2Bytes
178	Reserved		2Bytes
179	Reserved		2Bytes
180	Reserved		2Bytes
181	Reserved		2Bytes
182	Reserved		2Bytes
183	Reserved		2Bytes
184	Reserved		2Bytes
185	Reserved		2Bytes
186	Reserved		2Bytes
187	Reserved		2Bytes
188	Reserved		2Bytes
189	Gen Status	Generator Status Form	2Bytes
190	Gen Delay		2Bytes
191	Remote Start Status	Remote Start Status Form	2Bytes
192	Remote Start Delay		2Bytes
193	Breaker Status	Breaker Status Form	2Bytes
194	Transfer Rest		2Bytes
195	Reserved		2Bytes
196	Reserved		2Bytes

Appendix

Data Telegrams > Read Holding Registers 03_...

Address	Items	Description	Bytes Count
197	Reserved		2Bytes
198	Reserved		2Bytes
199	Run Time (HH)		2Bytes
200	Run Time (MM)		2Bytes
201	Run Time (SS)		2Bytes
202	Accumulated Start Times		2Bytes
0203 0204	Accumulated Energy kWh		4Bytes
0205 0206	Accumulated Energy kVarh		4Bytes
0207 0208	Accumulated Energy kVAh		4Bytes
0209 0210	Reserved		4Bytes
211	Maintenance Remain Time (HH)		2Bytes
212	Maintenance Remain Time (MM)		2Bytes
213	Maintenance Remain Time (SS)		2Bytes
214	Reserved		2Bytes
215	Reserved		2Bytes
216	Reserved		2Bytes
217	Model		2Bytes
218	Software Version	(*10)	2Bytes
219	Hardware Version	(*10)	2Bytes
220	Issue Date (YY)	Save the last two digits only.	2Bytes
221	Issue Date (MM)		2Bytes
222	Issue Date (DD)		2Bytes
223	Reserved		2Bytes
224	Reserved		2Bytes
225	Controller Current Time (YY)	Save the last two digits only.	2Bytes
226	Controller Current Time (MM)		2Bytes
227	Controller Current Time (DD)		2Bytes
228	Controller Current Time (Week)		2Bytes
229	Controller Current Time (HH)		2Bytes
230	Controller Current Time (MM)		2Bytes
231	Controller Current Time (SS)		2Bytes
232	Reserved		2Bytes
233	Reserved		2Bytes
234	Reserved		2Bytes
235	Reserved		2Bytes
236	Reserved		2Bytes
237	Reserved		2Bytes

Address	Items	Description	Bytes Count
238	Reserved		2Bytes
239	Reserved		2Bytes
240	Reserved		2Bytes
241	Reserved		2Bytes
242	Reserved		2Bytes
243	Reserved		2Bytes
244	Reserved		2Bytes
245	Reserved		2Bytes
246	Reserved		2Bytes
247	Reserved		2Bytes
248	Reserved		2Bytes
249	Reserved		2Bytes
250	Reserved		2Bytes
251	Reserved		2Bytes
252	Reserved		2Bytes
253	Reserved		2Bytes
254	Reserved		2Bytes
255	Reserved		2Bytes
256	Reserved		2Bytes
257	Reserved		2Bytes
258	Reserved		2Bytes
259	Reserved		2Bytes
260	Reserved		2Bytes
261	Reserved		2Bytes
262	Reserved		2Bytes
263	Reserved		2Bytes
264	Reserved		2Bytes
265	Reserved		2Bytes
266	Reserved		2Bytes
267	Reserved		2Bytes
268	Reserved		2Bytes
269	Reserved		2Bytes
270	Reserved		2Bytes
271	Reserved		2Bytes
272	Reserved		2Bytes
273	Reserved		2Bytes
274	Reserved		2Bytes

Appendix

Data Telegrams > Read Holding Registers 03_...

Address	Items	Description	Bytes Count
275	Reserved		2Bytes
276	Reserved		2Bytes
277	Reserved		2Bytes
278	Reserved		2Bytes
279	Reserved		2Bytes
280	Reserved		2Bytes
281	Reserved		2Bytes
282	Reserved		2Bytes
283	Reserved		2Bytes
284	Reserved		2Bytes
285	Reserved		2Bytes
286	Reserved		2Bytes
287	Reserved		2Bytes
288	Reserved		2Bytes
289	Reserved		2Bytes
290	Reserved		2Bytes
291	Reserved		2Bytes
292	Reserved		2Bytes
293	Reserved		2Bytes
294	Reserved		2Bytes
295	Reserved		2Bytes
296	Reserved		2Bytes
297	Reserved		2Bytes
298	Reserved		2Bytes
299	Reserved		2Bytes
300	Reserved		2Bytes
301	Reserved		2Bytes
302	Reserved		2Bytes
303	Reserved		2Bytes
304	Reserved		2Bytes
305	Reserved		2Bytes
306	Reserved		2Bytes
307	Reserved		2Bytes
308	Reserved		2Bytes
309	Reserved		2Bytes
310	Reserved		2Bytes

Address	Items	Description	Bytes Count
311	Reserved		2Bytes
312	Reserved		2Bytes

9.3.3 Force Single Coil 05H_hex



If an easYgen model does not support an information or detail, value will be empty.

Address	Item	Description
0	Remote Start Key	1 for active
1	Remote Stop Key	1 for active
2	Reserved	1 for active
3	Remote Auto Key	1 for active
4	Remote Manual Key	1 for active
5	Reserved	1 for active
6	Remote Generator Close/Open Key	1 for active
7	Remote Up Key	1 for active
8	Remote Down Key	1 for active
9	Remote Left Key	1 for active
10	Remote Right Key	1 for active
11	Remote Confirm Key	1 for active
12	Remote Mute Key	1 for active
13	Reserved	1 for active
14	Reserved	1 for active
15	Remote Fast Stop Key	1 for active
16	Reserved	1 for active
17	Reserved	1 for active
18	Reserved	1 for active
19	Remote Output 1	1 for active; 0 for inactive
20	Remote Output 2	1 for active; 0 for inactive
21	Remote Output 3	1 for active; 0 for inactive
22	Remote Output 4	1 for active; 0 for inactive
23	Remote Output 5	1 for active; 0 for inactive
24	Remote Output 6	1 for active; 0 for inactive
25	Reserved	1 for active
26	Reserved	1 for active
27	Reserved	1 for active
28	Reserved	1 for active

Appendix

Data Telegrams > Preset Single Register 06H... > Remote Start Status

9.3.4 Preset Single Register 06H_hex

9.3.4.1 Generator Status



If an easYgen model does not support an information or detail, value will be empty.

No.	Items	Description
0	At Rest	This status has no –delay value
1	Pre-heating	
2	Fuel On	This status has no –delay value
3	Cranking	
4	Crank Rest	
5	Safety On	
6	Start Idle	
7	Warming Up	
8	Waiting for Load	This status has no –delay value
9	Normal Running	This status has no –delay value
10	Cooling Down	
11	Stop Idle	
12	ETS Hold	
13	Wait for Stop	
14	After Stop	
15	Failed to Stop	This status has no –delay value

9.3.4.2 Remote Start Status

No.	Items	Description
0	No Delay	This status has no –delay value
1	Start Delay	
2	Stop Delay	

9.3.4.3 Breaker Status



If an easYgen model does not support an information or detail, value will be empty.

No.	Items	Description
0	Load Off	This status has no –delay value
1	Reserved	
2	Gen Closed	This status has no –delay value
3	Opening	
4	Transfer Rest	
5	Reserved	
6	Closing Gen	
7	Wait for Opened	This status has no –delay value
8	Wait for Gen Closed	This status has no –delay value
9	Reserved	
10	OK	This status has no –delay value

Appendix

Data Telegrams > Preset Single Register 06H... > Breaker Status

10 Glossary And List Of Abbreviations

AM	AnalogManager
BDEW	German community of 1,800 companies represented by the German Association of Energy and Water Industries (Bundesverband der Energie- und Wasserwirtschaft)
CB	Circuit Breaker
CL	Code Level
CT	Current Transformer
DI	Discrete Input
DO	Discrete (Relay) Output
ECU	Engine Control Unit
FMI	Failure Mode Indicator
GAP	Graphical Application Programming (GAP™)
GCB	Generator Circuit Breaker
GCP	Woodward device series (Genset Control) - not preferred for new design!
GGB	Generator Group Breaker
GOV	(speed) Governor; rpm regulator
HMI	Human Machine Interface e.g., a front panel with display and buttons for interaction
I	Current
IOP	Islanded Operation in Parallel ("Islanded Parallel Operation")
LDSS	Load-Dependent Start/Stop operation
LM	LogicsManager©
LSG	Woodward device: Load Share Gateway (communication converter)
MCB	Mains Circuit Breaker
MFR	Woodward device series (multifunctional relays) - not preferred for new design!
MOP	Mains Operation in Parallel
MPU	Magnetic Pickup Unit
N.C.	Normally Closed (break) contact
N.O.	Normally Open (make) contact
NC	Neutral Contactor
OC	Occurrence Count
Operation	In (general) operation. State when the genset is running according to the selected mode, all parameters are in allowed values and ranges, and without OPEN requests or alarms. Somehow "waiting for next occurrence".
P	Real power
P/N	Part Number
PF	Power Factor
PID	Proportional Integral Derivative controller

Glossary And List Of Abbreviations

PLC	Programmable Logic Control
PT	Potential (Voltage) Transformer
Q	Reactive power
S	Apparent power
S/N	Serial Number
Sequencer	A sequencer file is carrying specific settings e.g. to enable communication with and/or control of an expansion module. Such files can be prepared by Woodward.
SPN	Suspect Parameter Number
V	Voltage

11 Index

C

Contact person 11

Customer Service 11

I

Intended use 11, 20

P

Personnel 12

S

Service 11

Symbols

 in the instructions 9

U

Use 11, 20

W

Warranty 11



Designed in Europe

Woodward GmbH

Handwerkstrasse 29

70565 Stuttgart

Germany

Phone +49 (0) 711 789 54-510

Fax +49 (0) 711 789 54-101

Stgt-Doku@woodward.com