



DSE Genset®



DEEP SEA ELECTRONICS

DSE4510 MKII & DSE4520 MKII

Operator Manual

Document Number: 057-260

Author: Ashley Senior





Deep Sea Electronics Ltd.

Highfield House
Hunmanby
North Yorkshire
YO14 0PH
England

Sales Tel: +44 (0) 1723 890099

E-mail: sales@deepseaelectronics.com

Website: www.deepseaelectronics.com

DSE4510 MKII & DSE4520 MKII Operator Manual

© Deep Sea Electronics Ltd.

All rights reserved. No part of this publication may be reproduced in any material form (including photocopying or storing in any medium by electronic means or other) without the written permission of the copyright holder except in accordance with the provisions of the Copyright, Designs and Patents Act 1988.

Applications for the copyright holder's written permission to reproduce any part of this publication must be addressed to Deep Sea Electronics Ltd. at the address above.

The DSE logo and the names DSEGenset®, DSEATS®, DSEPower® and DSEControl® are UK registered trademarks of Deep Sea Electronics Ltd.

Any reference to trademarked product names used within this publication is owned by their respective companies.

Deep Sea Electronics Ltd. reserves the right to change the contents of this document without prior notice.

Amendments Since Last Publication

Issue No.	Comments
1	Initial Release
1.1	Changed output source 98 to reserved.
2	Update to Bibliography, J1939-75, Adding External Sounder, Module Display, Configurable CAN Instrumentation and Front Panel Editor
3	Update to Analogue Input A Specification, Alarm Icons and Front Panel Editor.
4	Addition of Current Configuration to Analogue Input A Specification, update to FPE list.
5	Add custom icons for user configured inputs and wait to start.
6	Added Part Numbering Info, DC Output F 5V Specification, Sensor Wiring Diagrams, Text Icons and FPE Additions.

TABLE OF CONTENTS

SECTION	PAGE
1 INTRODUCTION.....	7
1.1 CLARIFICATION OF NOTATION.....	8
1.2 GLOSSARY OF TERMS.....	8
1.3 BIBLIOGRAPHY.....	10
1.3.1 INSTALLATION INSTRUCTIONS.....	10
1.3.2 MANUALS.....	10
1.3.3 TRAINING GUIDES.....	11
1.3.4 THIRD PARTY DOCUMENTS.....	11
2 SPECIFICATION.....	12
2.1 PART NUMBERING.....	12
2.2 OPERATING TEMPERATURE.....	12
2.2.1 OPTIONAL HEATED SCREEN OPERATION.....	12
2.3 REQUIREMENTS FOR UL.....	13
2.4 TERMINAL SPECIFICATION.....	13
2.5 POWER SUPPLY REQUIREMENTS.....	14
2.5.1 MODULE SUPPLY INSTRUMENTATION DISPLAY.....	14
2.6 VOLTAGE & FREQUENCY SENSING.....	14
2.7 CURRENT SENSING.....	15
2.7.1 VA RATING OF THE CTS.....	15
2.7.2 CT POLARITY.....	16
2.7.3 CT PHASING.....	16
2.7.4 CT CLASS.....	16
2.8 INPUTS.....	17
2.8.1 DIGITAL INPUTS.....	17
2.8.2 ANALOGUE INPUTS.....	17
2.8.2.1 ANALOGUE INPUT A.....	17
2.8.2.2 ANALOGUE INPUT B.....	18
2.8.2.3 ANALOGUE INPUT C.....	18
2.8.3 CHARGE FAIL INPUT.....	19
2.9 OUTPUTS.....	19
2.9.1 DC OUTPUTS A & B (FUEL & START).....	19
2.9.2 DC OUTPUTS C, D & E.....	19
2.9.3 DC OUTPUT F.....	19
2.10 COMMUNICATION PORTS.....	20
2.11 COMMUNICATION PORT USAGE.....	21
2.11.1 USB SLAVE PORT (PC CONFIGURATION).....	21
2.11.2 CAN PORT (J1939).....	22
2.11.2.1 J1939-75.....	23
2.12 ADDING AN EXTERNAL SOUNDER.....	24
2.13 ACCUMULATED INSTRUMENTATION.....	25
2.14 DIMENSIONS AND MOUNTING.....	25
2.14.1 DIMENSIONS.....	25
2.14.2 PANEL CUTOUT.....	25
2.14.3 WEIGHT.....	25
2.14.4 FIXING CLIPS.....	26
2.14.5 OPTIONAL SILICON SEALING GASKET.....	27
2.15 APPLICABLE STANDARDS.....	28
2.15.1 ENCLOSURE CLASSIFICATIONS.....	30
2.15.1.1 IP CLASSIFICATIONS.....	30
2.15.1.2 NEMA CLASSIFICATIONS.....	30
3 INSTALLATION.....	31
3.1 USER CONNECTIONS.....	31
3.2 CONNECTION DESCRIPTIONS.....	32
3.2.1 DC SUPPLY, DC OUTPUTS & CHARGE FAIL INPUT.....	32

3.2.2	ANALOGUE SENSOR INPUTS	33
3.2.3	CONFIGURABLE DIGITAL INPUTS & CAN.....	34
3.2.4	GENERATOR & MAINS VOLTAGE & FREQUENCY SENSING	35
3.2.5	CURRENT TRANSFORMERS.....	36
3.2.5.1	CT CONNECTIONS.....	36
3.2.6	USB SLAVE (PC CONFIGURATION) CONNECTOR.....	37
3.3	TYPICAL WIRING DIAGRAM	38
3.3.1	DSE4510 MKII TYPICAL WIRING DIAGRAM (3 PHASE 4 WIRE)	39
3.3.2	DSE4520 MKII TYPICAL WIRING DIAGRAM (3 PHASE 4 WIRE)	40
3.3.3	EARTH SYSTEMS	41
3.3.3.1	NEGATIVE EARTH.....	41
3.3.3.2	POSITIVE EARTH.....	41
3.3.3.3	FLOATING EARTH.....	41
3.3.4	TYPICAL 4 MA TO 20 MA AND 0 V TO 10 V SENSOR WIRING.....	42
3.4	ALTERNATE TOPOLOGY WIRING DIAGRAMS	46
3.4.1	GENERATOR.....	46
3.4.2	MAINS (DSE4520 MKII ONLY).....	47
4	DESCRIPTION OF CONTROLS.....	48
4.1	CONTROL PUSH BUTTONS	49
4.2	MODULE DISPLAY.....	51
4.2.1	INSTRUMENTATION ICONS	52
4.2.2	ACTIVE CONFIGURATION	54
4.2.3	FRONT PANEL EDITOR (FPE) / AUTO RUN ICON.....	54
4.2.4	MODE ICON.....	55
4.2.5	LOAD SWITCHING ICON.....	55
4.2.6	SPLASH SCREEN.....	56
4.2.7	BACKLIGHT	56
4.2.8	ALARM ICONS (PROTECTIONS)	57
4.2.8.1	WARNING ALARM ICONS	58
4.2.8.2	ELECTRICAL TRIP ALARM ICONS.....	60
4.2.8.3	SHUTDOWN ALARM ICONS	62
4.3	VIEWING THE INSTRUMENT PAGES.....	65
4.3.1	NAVIGATION MENU	65
4.3.1.1	NAVIGATION MENU ICONS	66
4.3.2	GENERAL NAVIGATION.....	67
4.3.3	HOME	68
4.3.3.1	VOLTAGE INSTRUMENTATION	68
4.3.3.2	ENGINE TIER 4 INSTRUMENTATION	68
4.3.4	GENERATOR.....	69
4.3.5	MAINS (DSE4520 MKII ONLY).....	69
4.3.6	LOAD	70
4.3.7	ENGINE	71
4.3.8	CONFIGURABLE CAN INSTRUMENTS	72
4.3.9	INFO	72
4.3.10	ENGINE DTC (ECU ALARMS)	73
4.3.10.1	VIEWING ACTIVE ENGINE DTC.....	73
4.3.11	EVENT LOG.....	75
4.3.11.1	VIEWING THE EVENT LOG	75
4.3.12	ENGINE TIER 4 INFORMATION	76
4.3.12.1	ENGINE TIER 4 LAMPS.....	77
4.3.12.2	DPF INHIBIT CONTROL.....	78
5	OPERATION.....	79
5.1	QUICKSTART GUIDE.....	79
5.1.1	STARTING THE ENGINE	79
5.1.2	STOPPING THE ENGINE.....	80
5.2	STOP/RESET MODE	81
5.3	AUTOMATIC MODE	82
5.3.1	WAITING IN AUTO MODE	82
5.3.2	STARTING SEQUENCE.....	83

5.3.3	ENGINE RUNNING	84
5.3.4	STOPPING SEQUENCE	84
5.4	MANUAL/START MODE.....	85
5.4.1	STARTING SEQUENCE.....	85
5.4.2	ENGINE RUNNING	86
5.4.3	STOPPING SEQUENCE	86
5.5	MAINTENANCE ALARMS	87
5.6	SCHEDULER.....	88
5.6.1	STOP MODE.....	88
5.6.2	MANUAL MODE.....	88
5.6.3	AUTO MODE.....	88
5.8	ALTERNATIVE CONFIGURATIONS.....	89
6	FRONT PANEL CONFIGURATION.....	90
6.1	ACCESSING THE MAIN CONFIGURATION EDITOR	91
6.2	ENTERING PIN.....	91
6.3	EDITING A PARAMETER.....	92
6.4	EXITING THE MAIN CONFIGURATION EDITOR.....	92
6.5	ADJUSTABLE PARAMETERS.....	93
6.5.1	MODULE SETTINGS.....	93
6.5.2	CAN SETTINGS	94
6.5.3	DIGITAL INPUT SETTINGS.....	94
6.5.4	DIGITAL OUTPUT SETTINGS.....	94
6.5.5	TIMER SETTINGS.....	95
6.5.6	GENERATOR SETTINGS	96
6.5.7	MAINS SETTINGS	97
6.5.8	ENGINE SETTINGS	98
6.5.9	ANALOGUE INPUT SETTINGS.....	99
6.5.10	SCHEDULER SETTINGS.....	100
6.5.11	TIME SETTINGS	100
6.5.12	MAINTENANCE ALARM SETTINGS	101
6.5.13	ALTERNATIVE CONFIGURATION 1 SETTINGS.....	102
6.5.14	ALTERNATIVE CONFIGURATION 2 SETTINGS.....	104
6.5.15	ALTERNATIVE CONFIGURATION 3 SETTINGS.....	106
6.6	SELECTABLE PARAMETERS	108
6.6.1	INPUT SOURCES	108
6.6.2	OUTPUT SOURCES	109
6.6.3	ALARM ACTION.....	112
6.6.4	POWER UP MODE	112
6.6.5	AC SYSTEM.....	112
6.6.6	DIGITAL INPUT ALARM ARMING	112
6.6.7	DIGITAL INPUT POLARITY.....	112
6.6.8	OUTPUT POLARITY	112
7	COMMISSIONING	113
8	CAN INTERFACE SPECIFICATION (J1939-75).....	114
8.1	BROADCAST MESSAGES J1939-75	114
8.1.1	ACS - AC SWITCHING DEVICE STATUS	115
8.1.2	GC1 - GENERATOR CONTROL 1.....	115
8.1.3	GAAC - GENERATOR AVERAGE BASIC AC QUANTITIES	116
8.1.4	GPAAC - GENERATOR PHASE A BASIC AC QUANTITIES	116
8.1.5	GPAACP - GENERATOR PHASE A AC POWER	116
8.1.6	GPAACR - GENERATOR PHASE A AC REACTIVE POWER.....	117
8.1.7	GPBAC - GENERATOR PHASE B BASIC AC QUANTITIES	117
8.1.8	GPBACP - GENERATOR PHASE B AC POWER	117
8.1.9	GPBACR - GENERATOR PHASE B AC REACTIVE POWER.....	118
8.1.10	GPCAC - GENERATOR PHASE C BASIC AC QUANTITIES	118
8.1.11	GPCACP - GENERATOR PHASE C AC POWER.....	118
8.1.12	GPCACR - GENERATOR PHASE C AC REACTIVE POWER	119
8.1.13	GTACPP - GENERATOR TOTAL AC PERCENT POWER.....	119

8.1.14	GTACE - GENERATOR TOTAL KW HOURS EXPORT	119
8.1.15	GTACER - GENERATOR TOTAL AC REACTIVE ENERGY	119
8.1.16	GTACP - GENERATOR TOTAL AC POWER.....	120
8.1.17	GTACR - GENERATOR TOTAL AC REACTIVE POWER	120
8.2	BROADCAST MESSAGES ENGINE INSTRUMENTATION	120
8.2.1	DD - DASH DISPLAY	120
8.2.2	EC2 - ENGINE CONFIGURATION 2.....	121
8.2.3	EEC1- ENGINE SPEED	121
8.2.4	EEC4 - CRANK ATTEMPT COUNT ON PRESENT START ATTEMPT	121
8.2.5	EFL_P1 - OIL PRESSURE	121
8.2.6	EOI - EMERGENCY STOP.....	122
8.2.7	ET1 - COOLANT TEMPERATURE	122
8.2.8	HOURS - ENGINE HOURS REVOLUTIONS	122
8.2.9	VEP1 - VEHICLE ELECTRICAL POWER	122
8.3	DM01 - CONDITIONS ACTIVE DIAGNOSTIC TROUBLE CODES	123
9	FAULT FINDING.....	124
9.1	STARTING.....	124
9.2	LOADING.....	124
9.3	ALARMS.....	125
9.4	COMMUNICATIONS	125
9.5	INSTRUMENTS.....	125
9.6	MISCELLANEOUS.....	126
10	MAINTENANCE, SPARES, REPAIR AND SERVICING	127
10.1	PURCHASING ADDITIONAL CONNECTOR PLUGS FROM DSE.....	127
10.1.1	PACK OF PLUGS.....	127
10.1.2	INDIVIDUAL PLUGS	127
10.2	PURCHASING ADDITIONAL FIXING CLIPS FROM DSE	127
10.3	PURCHASING ADDITIONAL SEALING GASKET FROM DSE	127
11	WARRANTY	128
12	DISPOSAL	128
12.1	WEEE (WASTE ELECTRICAL AND ELECTRONIC EQUIPMENT).....	128

1 INTRODUCTION

This document details the installation and operation requirements of the DSE4510 MKII and DSE4520 MKII module and is part of the DSEGenset® range of products.

The manual forms part of the product and should be kept for the entire life of the product. If the product is passed or supplied to another party, ensure that this document is passed to them for reference purposes.

This is not a *controlled document*. DSE do not automatically inform on updates. Any future updates of this document are included on the DSE website at www.deepseaelectronics.com

The DSE4xxx MKII series is designed to provide differing levels of functionality across a common platform. This allows the generator OEM greater flexibility in the choice of controller to use for a specific application.

The DSE45xx MKII modules have been designed to allow the operator to start and stop the generator, and if required, transfer the load to the generator either manually or automatically. Additionally, the DSE4520 MKII automatically starts and stops the generator set depending upon the status of the mains (utility) supply.

The user also has the facility to view the system operating parameters via the text LCD display.

The DSE45xx MKII modules monitor the engine, indicating the operational status and fault conditions, automatically shutting down the engine and giving a true first up fault condition of an engine failure by the text LCD display.

The powerful ARM microprocessor contained within the module allows for incorporation of a range of complex features:

- *Icon based LCD display*
- **True RMS Voltage**
- *Current and Power monitoring*
- *USB Communications*
- *Engine parameter monitoring.*
- *Fully configurable inputs for use as alarms or a range of different functions.*
- *Engine ECU interface to **electronic engines***



The DSE Configuration Suite PC Software allows alteration of selected operational sequences, timers, alarms, and operational sequences. Additionally, the module's integral front panel configuration editor allows adjustment of this information.

Access to critical operational sequences and timers for use by qualified engineers, can be protected by a security code. Module access can also be protected by PIN code. Selected parameters can be changed from the module's front panel.

The module is housed in a robust plastic case suitable for panel mounting. Connections to the module are via locking plug and sockets.

1.1 CLARIFICATION OF NOTATION

Clarification of notation used within this publication.

	NOTE:	Highlights an essential element of a procedure to ensure correctness.
	CAUTION!	Indicates a procedure or practice, which, if not strictly observed, could result in damage or destruction of equipment.
	WARNING!	Indicates a procedure or practice, which could result in injury to personnel or loss of life if not followed correctly.

1.2 GLOSSARY OF TERMS

Term	Description
DSE4000 MKII, DSE4xxx MKII	All modules in the DSE4xxx MKII range.
DSE4500 MKII, DSE45xx MKII	All modules in the DSE45xx MKII range.
DSE4510 MKII	DSE4510 MKII module/controller
DSE4520 MKII	DSE4520 MKII module/controller
CAN	Controller Area Network Vehicle standard to allow digital devices to communicate to one another.
CDMA	Code Division Multiple Access. Cell phone access used in small number of areas including parts of the USA and Australia.
CT	Current Transformer An electrical device that takes a large AC current and scales it down by a fixed ratio to a smaller current.
BMS	Building Management System A digital/computer based control system for a building's infrastructure.
DEF	Diesel Exhaust Fluid (AdBlue) A liquid used as a consumable in the SCR process to lower nitric oxide and nitrogen dioxide concentration in engine exhaust emissions.
DM1	Diagnostic Message 1 A DTC that is currently active on the engine ECU.
DM2	Diagnostic Message 2 A DTC that was previously active on the engine ECU and has been stored in the ECU's internal memory.
DPF	Diesel Particulate Filter A filter fitted to the exhaust of an engine to remove diesel particulate matter or soot from the exhaust gas.
DPTC	Diesel Particulate Temperature Controlled Filter A filter fitted to the exhaust of an engine to remove diesel particulate matter or soot from the exhaust gas which is temperature controlled.
DTC	Diagnostic Trouble Code The name for the entire fault code sent by an engine ECU.
ECU/ECM	Engine Control Unit/Management An electronic device that monitors engine parameters and regulates the fuelling.
FMI	Failure Mode Indicator A part of DTC that indicates the type of failure, e.g. high, low, open circuit etc.

Continued over page...

Introduction

Term	Description
GSM	Global System for Mobile communications. Cell phone technology used in most of the World.
HEST	High Exhaust System Temperature Initiates when DPF filter is full in conjunction with an extra fuel injector in the exhaust system to burn off accumulated diesel particulate matter or soot.
HMI	Human Machine Interface A device that provides a control and visualisation interface between a human and a process or machine.
OC	Occurrence Count A part of DTC that indicates the number of times that failure has occurred.
PGN	Parameter Group Number A CAN address for a set of parameters that relate to the same topic and share the same transmission rate.
PLC	Programmable Logic Controller A programmable digital device used to create logic for a specific purpose.
SCADA	Supervisory Control And Data Acquisition A system that operates with coded signals over communication channels to provide control and monitoring of remote equipment
SCR	Selective Catalytic Reduction A process that uses DEF with the aid of a catalyst to convert nitric oxide and nitrogen dioxide into nitrogen and water to reduce engine exhaust emission.
SIM	Subscriber Identity Module. The small card supplied by the GSM/CDMA provider that is inserted into the cell phone, GSM modem or DSEGateway device to give GSM/GPRS connection.
SMS	Short Message Service The text messaging service of mobile/cell phones.
SPN	Suspect Parameter Number A part of DTC that indicates what the failure is, e.g. oil pressure, coolant temperature, turbo pressure etc.

1.3 BIBLIOGRAPHY

This document refers to and is referred by the following DSE publications which are obtained from the DSE website: www.deepseaelectronics.com or by contacting DSE technical support: support@deepseaelectronics.com.

1.3.1 INSTALLATION INSTRUCTIONS

Installation instructions are supplied with the product in the box and are intended as a 'quick start' guide only.

DSE Part	Description
053-190	DSE4510 MKII & DSE4520 MKII Installation Instructions

1.3.2 MANUALS

Product manuals are obtained from the DSE website: www.deepseaelectronics.com or by contacting DSE technical support: support@deepseaelectronics.com.

DSE Part	Description
N/A	Gencomm (MODBUS protocol for DSE controllers)
057-004	Electronic Engines and DSE Wiring Guide
057-151	DSE Configuration Suite PC Software Installation & Operation Manual
057-220	Options for Communications with DSE Controllers
057-258	DSE4510 MKII & DSE4520 MKII DSE Configuration Suite PC Software Manual

1.3.3 TRAINING GUIDES

Training guides are provided as 'hand-out' sheets on specific subjects during training sessions and contain specific information regarding to that subject.

DSE Part	Description
056-005	Using CTs With DSE Products
056-006	Introduction to Comms
056-010	Over Current Protection
056-022	Breaker Control
056-023	Adding New CAN Files
056-026	kW, kvar, kVA and pf.
056-029	Smoke Limiting
056-030	Module PIN Codes
056-055	Alternate Configurations
056-069	Firmware Update
056-075	Adding Language Files
056-076	Reading DSEGencomm Alarms
056-079	Reading DSEGencomm Status
056-080	MODBUS
056-081	Screen Heaters
056-082	Override Gencomm PLC Example
056-091	Equipotential Earth Bonding
056-092	Best Practices for Wiring Resistive Sensors
056-095	Remote Start Input Functions
056-097	USB Earth Loop and Isolation

1.3.4 THIRD PARTY DOCUMENTS

The following third party documents are also referred to:

Reference	Description
ISBN 1-55937-879-4	IEEE Std C37.2-1996 IEEE Standard Electrical Power System Device Function Numbers and Contact Designations. Institute of Electrical and Electronics Engineers Inc
ISBN 0-7506-1147-2	Diesel generator handbook. L.L.J. Mahon
ISBN 0-9625949-3-8	On-Site Power Generation. EGSA Education Committee.

2 SPECIFICATION

2.1 PART NUMBERING

At the time of this document production, there are two variants of this product.

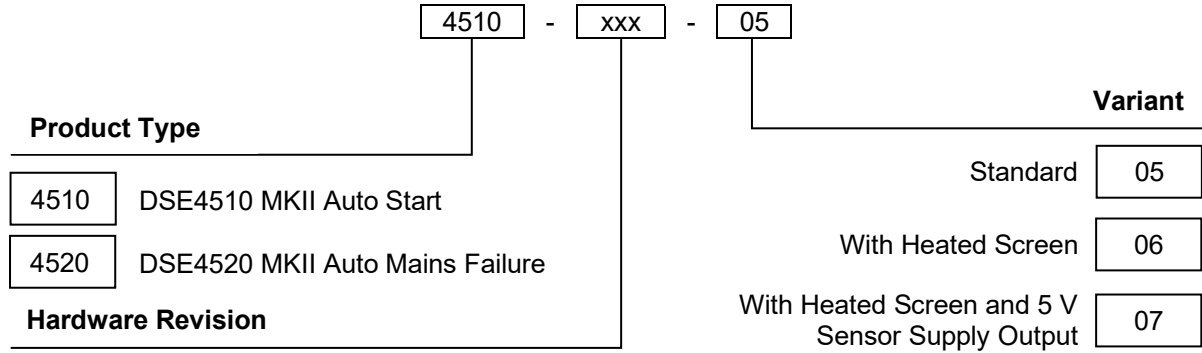

2.2 OPERATING TEMPERATURE

Module	Specification
Standard Variants	-30 °C +70 °C (-22 °F +158 °F)
Display Heater Variants	-40 °C +70 °C (-40 °F +158 °F)

2.2.1 OPTIONAL HEATED SCREEN OPERATION

Screen Heater Function	Specification
Turn On When Temperature Falls Below	-10 °C (+14 °F)
Turn Off When Temperature Rises Above	-5 °C (+23 °F)

2.3 REQUIREMENTS FOR UL

 **WARNING!** More than one live circuit exists, refer to section entitled *Typical Wiring Diagram* elsewhere in this document

Description	Specification
Screw Terminal Tightening Torque	4.5 lb-in (0.5 Nm)
Conductors	<ul style="list-style-type: none"> Terminals suitable for connection of conductor size 13 AWG to 20 AWG (0.5 mm² to 2.5 mm²). Conductor protection must be provided in accordance with NFPA 70, Article 240 Low voltage circuits (35 V or less) must be supplied from the engine starting battery or an isolated secondary circuit. The communication, sensor, and/or battery derived circuit conductors shall be separated and secured to maintain at least ¼" (6 mm) separation from the generator and mains connected circuit conductors unless all conductors are rated 600 V or greater.
Current Inputs	Must be connected through UL Listed or Recognized isolating current transformers with the secondary rating of 5 A max.
Communication Circuits	Must be connected to communication circuits of UL Listed equipment
Output Pilot Duty	0.5 A
Mounting	<ul style="list-style-type: none"> Suitable for use in type 1 Enclosure Type rating with surrounding air temperature -22 °F to +158 °F (-30 °C to +70 °C) Suitable for pollution degree 3 environments when voltage sensing inputs do not exceed 300 V. When used to monitor voltages over 300 V device to be installed in an unventilated or filtered ventilation enclosure to maintain a pollution degree 2 environment.
Operating Temperature	-22 °F to +158 °F (-30 °C to +70 °C)
Storage Temperature	-40 °F to +176 °F (-40 °C to +80 °C)

2.4 TERMINAL SPECIFICATION

Description	Specification	
Connection Type	Two part connector. Male part fitted to module Female part supplied in module packing case - Screw terminal, rising clamp, no internal spring.	 Example showing cable entry and screw terminals of a 10 way connector
Minimum Cable Size	0.5 mm ² (AWG 20)	
Maximum Cable Size	2.5 mm ² (AWG 13)	
Tightening Torque	0.5 Nm (4.5 lb-in)	
Wire Strip Length	7 mm (9/32")	

2.5 POWER SUPPLY REQUIREMENTS

Description	Specification
Minimum Supply Voltage	8 V continuous, 5 V for up to 1 minute.
Cranking Dropouts	Able to survive 0 V for 100 ms providing the supply was at least was greater than 5 V for 2 seconds before the dropout and recovers to 5 V afterwards.
Maximum Supply Voltage	35 V continuous (60 V protection)
Reverse Polarity Protection	-35 V continuous
Maximum Operating Current	96 mA at 12 V 85 mA at 24 V
Maximum Standby Current	51 mA at 12 V 47 mA at 24 V
Maximum Current When In Sleep Mode	35 mA at 12 V 32 mA at 24 V
Maximum Current When In Deep Sleep Mode	Less than 10 μ A at 12 V Less than 10 μ A at 24 V
Typical Power (Controller On, Heater Off)	3.8 W to 4.1 W
Typical Power (Controller On, Heater On)	6.8 W to 7.1 W

2.5.1 MODULE SUPPLY INSTRUMENTATION DISPLAY

Description	Specification
Range	0 V to 70 V DC (Maximum continuous operating voltage of 35 V DC)
Resolution	0.1 V
Accuracy	1 % full scale (± 0.35 V)

2.6 VOLTAGE & FREQUENCY SENSING

Description	Specification
Measurement Type	True RMS conversion
Harmonics	Up to 11 th
Input Impedance	450 k Ω phase to neutral
Phase To Neutral	15 V (minimum required for sensing frequency) to 415 V AC (absolute maximum) Suitable for 345 V AC nominal (± 20 % for under/overvoltage detection)
Phase To Phase	25 V (minimum required for sensing frequency) to 720 V AC (absolute maximum) Suitable for 600 V AC nominal (± 20 % for under/overvoltage detection)
Common Mode Offset From Earth	100 V AC (max)
Resolution	1 V AC phase to neutral 2 V AC phase to phase
Accuracy	± 1 % of full scale phase to neutral ± 2 % of full scale phase to phase
Minimum Frequency	3.5 Hz
Maximum Frequency	75.0 Hz
Frequency Resolution	0.1 Hz
Frequency Accuracy	± 0.05 Hz

2.7 CURRENT SENSING

Description	Specification
Measurement Type	True RMS conversion
Harmonics	Up to 11 th
Nominal CT Secondary Rating	1 A and 5 A
Maximum Continuous Current	5 A
Absolute Maximum Overload	15 A for 1 second
Burden	0.25 VA (0.01 Ω current shunts)
Resolution	25 mA
Accuracy	±1 % of Nominal (excluding CT error)

2.7.1 VA RATING OF THE CTS

NOTE: Details for 4 mm² cables are shown for reference only. The connectors on the DSE modules are only suitable for cables up to 2.5 mm².

The VA burden of the module on the CTs is 0.25 VA. However, depending upon the type and length of cabling between the CTs and the module, CTs with a greater VA rating than the module are required.

The distance between the CTs and the measuring module should be estimated and cross-referenced against the chart opposite to find the VA burden of the cable itself.

If the CTs are fitted within the alternator top box, the star point (common) of the CTs should be connected to system ground (earth) as close as possible to the CTs. This minimises the length of cable used to connect the CTs to the DSE module.

Example:

If 1.5 mm² cable is used and the distance from the CT to the measuring module is 20 m, then the burden of the cable alone is approximately 15 VA. As the burden of the DSE controller is 0.25 VA, then a CT with a rating of at least 15 VA + 0.25 VA = 15.25 VA

must be used. If 2.5 mm² cables are used over the same distance of 20 m, then the burden of the cable on the CT is approximately 7 VA. CT's required in this instance is at least 7.25 VA (7 + 0.25).

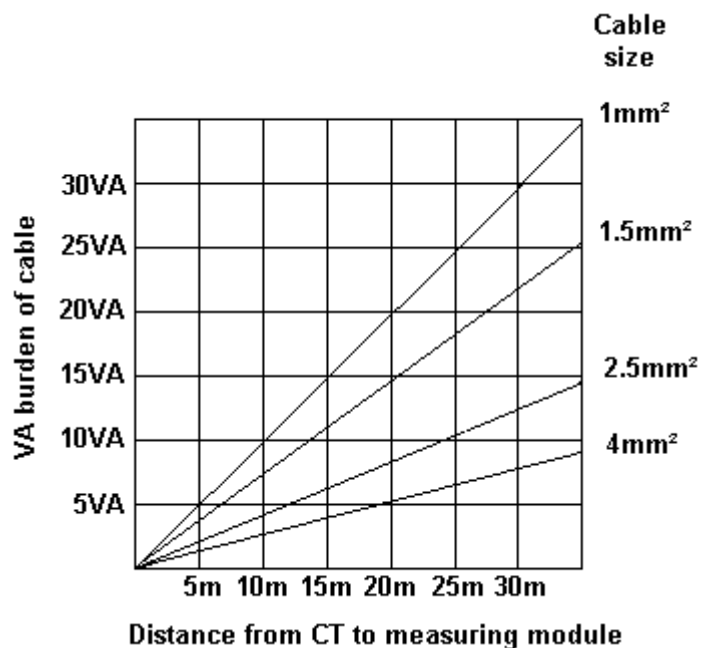

2.7.2 CT POLARITY

NOTE: Take care to ensure correct polarity of the CT primary as shown above. If in doubt, check with the CT supplier.

Take care to ensure the correct polarity of the CTs. Incorrect CT orientation leads to negative kW readings when the set is supplying power. Take note that paper stick-on labels on CTs that show the orientation are often incorrectly placed on the CT. It is more reliable to use the labelling in the case moulding as an indicator to orientation (if available).

To test orientation, run the generator in island mode (not in parallel with any other supply) and load the generator to around 10 % of the set rating. Ensure the DSE module shows positive kW for all three individual phase readings.

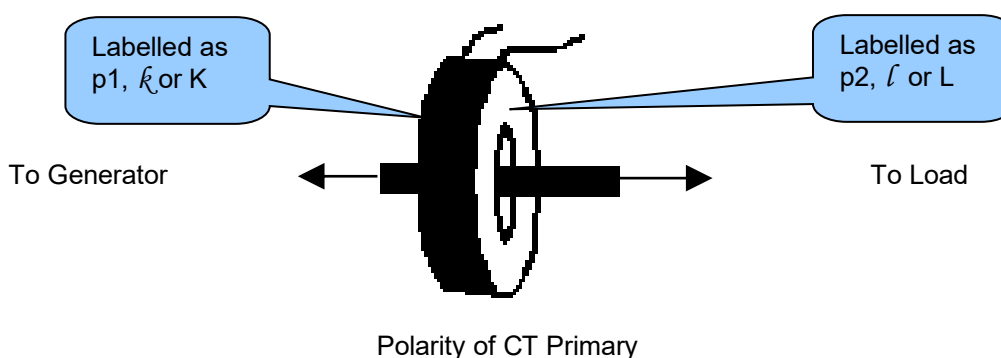

2.7.3 CT PHASING

Take particular care that the CTs are connected to the correct phases. For instance, ensure that the CT on phase 1 is connected to the terminal on the DSE module intended for connection to the CT for phase 1.

Additionally, ensure that the voltage sensing for phase 1 is connected to generator phase 1. Incorrect connection of the phases as described above results in incorrect power factor (pf) measurements, which in turn results in incorrect kW measurements.

One way to check for this is to make use of a single-phase load. Place the load on each phase in turn, run the generator and ensure the kW value appears in the correct phase. For instance, if the load is connected to phase 3, ensure the kW figure appears in phase 3 display and not in the display for phase 1 or 2.

2.7.4 CT CLASS

Ensure the correct CT type is chosen. For instance, if the DSE module is providing over current protection, ensure the CT is capable of measuring the overload level required to protect against, and at the accuracy level required.

For instance, this may mean fitting a protection class CT (P15 type) to maintain high accuracy while the CT is measuring overload currents.

Conversely, if the DSE module is using the CT for instrumentation only (current protection is disabled or not fitted to the controller), then measurement class CTs can be used. Again, bear in mind the accuracy required. The DSE module is accurate to better than 1% of the full-scale current reading. To maintain this accuracy, fit a Class 0.5 or Class 1 CT.

Check with the CT manufacturer for further advice on selecting CTs.

2.8 INPUTS

2.8.1 DIGITAL INPUTS

Description	Specification
Number	4 configurable digital inputs (7 when <i>Analogue Inputs</i> are configured as digital inputs)
Arrangement	Contact between terminal and ground
Low Level Threshold	3.2 V minimum
High Level Threshold	8.1 V maximum
Maximum Input Voltage	+60 V DC with respect to module DC supply negative
Minimum Input Voltage	-24 V DC with respect to module DC supply negative
Contact Wetting Current	6 mA typical
Open Circuit Voltage	12 V typical

2.8.2 ANALOGUE INPUTS

2.8.2.1 ANALOGUE INPUT A

Description	Specification
Input Type	Flexible: Configured for <i>Oil Sensor</i> in the DSE default configuration. Flexible Options: Not used, Digital Input, Flexible Analogue & Oil Sensor.
Flexible Input Selection	Pressure Sensor Percentage Sensor Temperature Sensor
Flexible Measured Quantity	Resistive Voltage Current

Resistive Configuration

Description	Specification
Measurement Type	Resistance measurement by measuring voltage across sensor with a fixed current applied
Arrangement	Differential resistance measurement input
Measurement Current	11 mA \pm 10%
Full Scale	240 Ω
Over Range / Fail	270 Ω
Resolution	0.1 bar (1 to 2 PSI)
Accuracy	\pm 2 % of full-scale resistance (\pm 4.8 Ω) excluding transducer error
Max Common Mode Voltage	\pm 2 V
Display Range	Configurable by PC Software

0 V to 10 V Configuration

 **NOTE: The 0 V to 10 V selection is only available on the 45xx-004-xx hardware variants.**

Description	Specification
Full Scale	0 V to 10 V
Resolution	1% of full scale
Accuracy	\pm 2% of full-scale voltage (\pm 0.2 V) excluding sensor error
Max Common Mode Voltage	\pm 2 V
Display Range	Configurable by PC Software

4 mA to 20 mA Configuration

▲ NOTE: The 4 mA to 20 mA selection is only available on the 45xx-004-xx hardware variants.

▲ NOTE: To use a 4 mA to 20 mA sensor, an external 240 Ω shunt resistor must be fitted across terminals 10 and 11. To attain the best possible accuracy, ensure a high accuracy resistor is used.

Description	Specification
Full Scale	0 mA to 20 mA
Resolution	2% of full scale
Accuracy	±4% of full-scale current (±0.8 mA) excluding sensor error and external shunt resistor error
Max Common Mode Voltage	±2 V
Display Range	Configurable by PC Software

2.8.2.2 ANALOGUE INPUT B

Description	Specification
Input Type	Coolant Temperature Sensor or Digital Input
Measurement Type	Resistance measurement by measuring voltage across sensor with a fixed current applied
Arrangement	Differential resistance measurement input
Measurement Current	11 mA ±10%
Full Scale	480 Ω
Over Range / Fail	600 Ω
Resolution	±1 % of full scale
Accuracy	±2% of full-scale resistance (±9.6 Ω) excluding transducer error
Max Common Mode Voltage	±2 V
Display Range	Configurable by PC Software

2.8.2.3 ANALOGUE INPUT C

Description	Specification
Input Type	Fuel Level Sensor, Flexible Sensor or Digital Input
Flexible Input Selection	Pressure Sensor, Percentage Sensor or Temperature Sensor
Measurement Type	Resistance measurement by measuring voltage across sensor with a fixed current applied
Arrangement	Differential resistance measurement input
Measurement Current	11 mA ±10 %
Full Scale	480 Ω
Over Range / Fail	600 Ω
Resolution	±1 % of full scale
Accuracy	±2 % of full-scale resistance (±9.6 Ω) excluding sensor error
Max Common Mode Voltage	±2 V
Display Range	Configurable by PC Software

2.8.3 CHARGE FAIL INPUT

The charge fail input is a combined input and output. Whenever the generator is required to run, the terminal provides excitation current to the charge alternator field winding.

When the charge alternator is correctly charging the battery, the voltage of the terminal is close to the plant battery supply voltage. In a failed charge situation, the voltage of this terminal is pulled down to a low voltage. It is this drop in voltage that triggers the *Charge Failure* alarm. The level at which this operates and whether this triggers a warning or shutdown alarm is configurable using the DSE Configuration Suite Software.

Description	Specification
Minimum Voltage	0 V
Maximum Voltage	35 V
Resolution	0.2 V
Accuracy	±1 % of full scale
Excitation	Active circuit constant power output
Output Power	2.5 W nominal at 12 V and 24 V
Current At 12V	210 mA
Current At 24V	105 mA

2.9 OUTPUTS

2.9.1 DC OUTPUTS A & B (FUEL & START)

Description	Specification
Type	Normally used as Fuel & Start outputs. Fully configurable for other purposes if the module is configured to control an electronic engine, supplied from DC supply terminal 2.
Rating	10 A resistive for 10 seconds, 5 A resistance continuous at module supply.

2.9.2 DC OUTPUTS C, D & E

Description	Specification
Type	Fully configurable, supplied from DC supply terminal 2.
Rating	2 A resistive at module supply.

2.9.3 DC OUTPUT F

DC Output Configuration

Description	Specification
Type	Fully configurable, supplied from DC supply terminal 2.
Rating	2 A resistive at module supply.

5 V Sensor Supply Output Configuration

 **NOTE:** The 5 V sensor supply output selection is only available on the 45xx-xxx-07 product variant.

Description	Specification
Type	Supplied from DC supply terminal 2.
Rating	20 mA resistive at 5 V.

2.10 COMMUNICATION PORTS

▲ NOTE: All communication ports can be used at the same time.

Description	Specification
USB Slave Port	Type B USB 2.0 For connection to PC running DSE Configuration Suite Max distance 6 m (20 feet)
CAN Port	<p data-bbox="528 495 1393 607">▲ NOTE: For additional length, the DSE124 CAN & MSC Extender is available. For more information, refer to DSE Publication: 057-116 DSE124 Operator Manual</p> <p data-bbox="528 618 1193 768">Engine CAN Port Standard implementation of 'Slow mode', up to 250 kb/s Non-Isolated. Internal Termination provided (120 Ω) Max distance 40 m (133 feet)</p>

2.11 COMMUNICATION PORT USAGE

2.11.1 USB SLAVE PORT (PC CONFIGURATION)

NOTE: DSE stock 2 m (6.5 feet) USB type A to type B cable, DSE Part Number: 016-125. Alternatively, they are purchased from any PC or IT store.

NOTE: The DC supply must be connected to the module for configuration by PC.

NOTE: For further details of module configuration, refer to DSE Publication: 057-258 *DSE4510 MKII & DSE4520 MKII Configuration Suite PC Software Manual.*

The USB port is provided to give a simple means of connection between a PC and the controller. Using the DSE Configuration Suite Software, the operator is then able to control the module, starting or stopping the engine, selecting operating modes, etc.

Additionally, the various operating parameters (such as coolant temperature, oil pressure, etc.) of the engine are available to be viewed or changed.

To connect a module to a PC by USB, the following items are required:

- DSE45xx MKII Module
- DSE Configuration Suite PC Software (Available from www.deepseaelectronics.com).

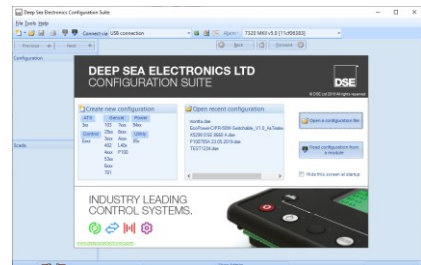

- USB cable Type A to Type B.
(This is the same cable as often used between a PC and a USB printer)
DSE stock this cable:
PC Configuration interface lead (USB type A – type B) DSE Part No 016-125



2.11.2 CAN PORT (J1939)

NOTE: For further details of module configuration, refer to DSE Publication: *057-258 DSE4510 MKII & DSE4520 MKII Configuration Suite PC Software Manual*.

NOTE: For further details on connection to electronic engines, refer to DSE Publication: *057-004 Electronic Engines And DSE Wiring*

NOTE: Screened 120 Ω impedance cable specified for use with CAN must be used for the CAN link.
DSE stock and supply Belden cable 9841 which is a high quality 120 Ω impedance cable suitable for CAN use (DSE part number 016-030)

NOTE: For additional length, the DSE124 CAN & MSC Extender is available. For more information, refer to DSE Publication: *057-116 DSE124 Operator Manual*

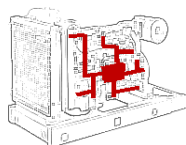

The modules are fitted with a CAN interface as standard and are capable of receiving engine data from engine ECU/ECMs compliant with the CAN J1939 standard.

ECU/ECMs monitor the engine's operating parameters such as speed, oil pressure, coolant temperature (among others) to closely monitor and control the engine. The industry standard communications interface (CAN) transports data gathered by the engine's ECU/ECM using the J1939 protocol. This allows engine controllers such as DSE to access these engine parameters with no physical connection to the sensor device.

The *ECU Port* is used for point-to-point cable connection of more than one device and allows for connection to CAN Scanner, PLC, and CAN controllers (to name just a few devices). The operator is then able to view the various operating parameters.

2.11.2.1 J1939-75

Note: For further details of module configuration, refer to DSE Publication: *057-258 DSE4520 MKII & DSE4520 MKII Configuration Suite PC Software Manual*.

NOTE: For further details of CAN communication, see the section entitled *CAN Interface Specification (J1939-75)* elsewhere in this document.

When the J1939-75 is enabled in the module's configuration, the module's AC measurements and alarms are sent onto the CANbus using the *ECU Port* to be received by an external monitoring device. There are two check boxes to enable each of the two parts of the interface as shown below, AC measurement and AC related alarms. The module AC alarms are translated into J1939 DM1 diagnostic messages. There are no additional display screens visible on the module when these options are selected. The default CAN source address for additional J1939-75 messages is 44 however this may be changed by the generator supplier.

Miscellaneous Options

J1939-75 Instrumentation Enable

J1939-75 Alarms Enable

CAN source address (instrumentation)

2.12 ADDING AN EXTERNAL SOUNDER

If an external alarm or indicator be required, this is achievable by using the DSE Configuration Suite PC software to configure an auxiliary output for *Audible Alarm*, and by configuring an auxiliary input for *Alarm Mute*.

The audible alarm output activates and de-activates at the same time as the module's internal sounder. The *Audible Alarm* output de-activates when the *Alarm Mute* input activates or after the *Audible Alarm Duration* time has ceased.

Example of configuration to achieve external sounder with external alarm mute button or an automatic mute after 1 minute and 30 seconds:

The screenshot displays four configuration panels from the DSE Configuration Suite software:

- Relay Outputs (DC Supply Out):** Shows 'Output E' configured with 'Source' set to 'Audible Alarm' and 'Polarity' set to 'Energise'.
- Digital Input A:** Shows 'Function' set to 'Alarm Mute', 'Polarity' set to 'Close to Activate', and 'Activation Delay' set to 0s.
- Module Options:** A list of options with checkboxes and a dropdown menu. 'Show Load Switching Icons' and 'Limit Audible Alarm Duration' are checked. 'Power Up In Mode' is set to 'Stop'.
- Module Timers:** A list of timers with sliders. 'Audible Alarm' is set to 20s.

Option	State
Lamp Test at Power-Up	<input type="checkbox"/>
Protected Start Mode	<input type="checkbox"/>
Event Log In Hours Run	<input type="checkbox"/>
Display SPN Strings	<input type="checkbox"/>
Enable Fast Loading	<input type="checkbox"/>
Maintenance Pin Protected Enable	<input type="checkbox"/>
Enable Cool Down In Stop Mode	<input type="checkbox"/>
Power Up In Mode	Stop
All warnings are latched	<input type="checkbox"/>
Enhanced Tier IV Home Screen	<input type="checkbox"/>
Show Load Switching Icons	<input checked="" type="checkbox"/>
Limit Audible Alarm Duration	<input checked="" type="checkbox"/>

Timer	Value
Backlight Power Save Mode Delay	1m
Power Save Mode Delay	1m
Deep Sleep Delay	1m 30s
Page Delay	5m
Audible Alarm	20s

2.13 ACCUMULATED INSTRUMENTATION

NOTE: When an accumulated instrumentation value exceeds the maximum number as listed below, the value is reset and begins counting from zero again.

The number of logged *Engine Hours* and *Number of Starts* can be set/reset using the DSE Configuration Suite PC software. Depending upon module configuration, this may have been PIN number locked by the generator supplier.

Description	Specification
Engine Hours Run	Maximum 99999 hrs 59 minutes (Approximately 11yrs 4 months)
Number of Starts	1,000,000 (1 Million)
Accumulated Power	999999 kWh / kvarh / kVAh

2.14 DIMENSIONS AND MOUNTING

2.14.1 DIMENSIONS

140 mm x 113 mm x 43 mm
(5.5 " x 4.4 " x 1.7 ")

2.14.2 PANEL CUTOUT

118 mm x 92 mm
(4.6 " x 3.6 ")

2.14.3 WEIGHT

0.16 kg
(0.35 lb)

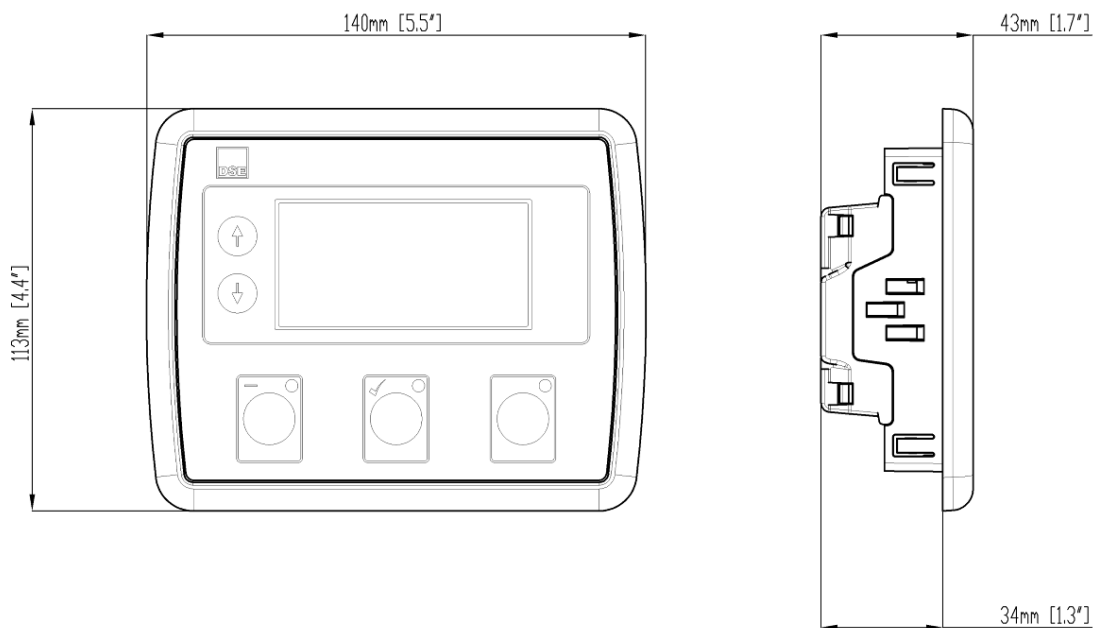

2.14.4 FIXING CLIPS

NOTE: In conditions of excessive vibration, mount the module on suitable anti-vibration mountings.

The module is held into the panel fascia using the supplied fixing clips.

- Withdraw the fixing clip screw (turn anticlockwise) until only the pointed end is protruding from the clip.
- Insert the two 'prongs' of the fixing clip into the slots in the side of the module case.
- Pull the fixing clip backwards (towards the back of the module) ensuring all three prongs of the clip are inside their allotted slots.
- Turn the fixing clip screws clockwise until they contact the panel fascia.
- Turn the screw a quarter of a turn to secure the module into the panel fascia. Care must be taken not to over tighten the fixing clip screws.

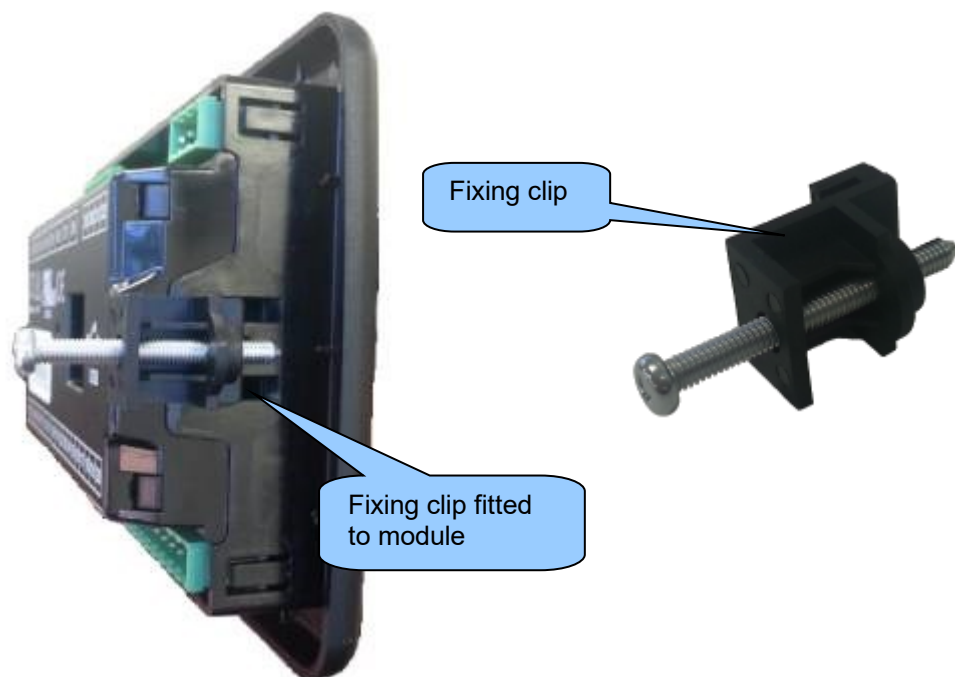

2.14.5 OPTIONAL SILICON SEALING GASKET

▲ NOTE: For purchasing a silicon gasket from DSE, see the section entitled **Maintenance, Spares, Repair and Servicing** elsewhere in this document.

The silicon gasket provides improved sealing between module and the panel fascia. The gasket is fitted to the module before installation into the panel fascia. Take care to ensure the gasket is correctly fitted to the module to maintain the integrity of the seal.

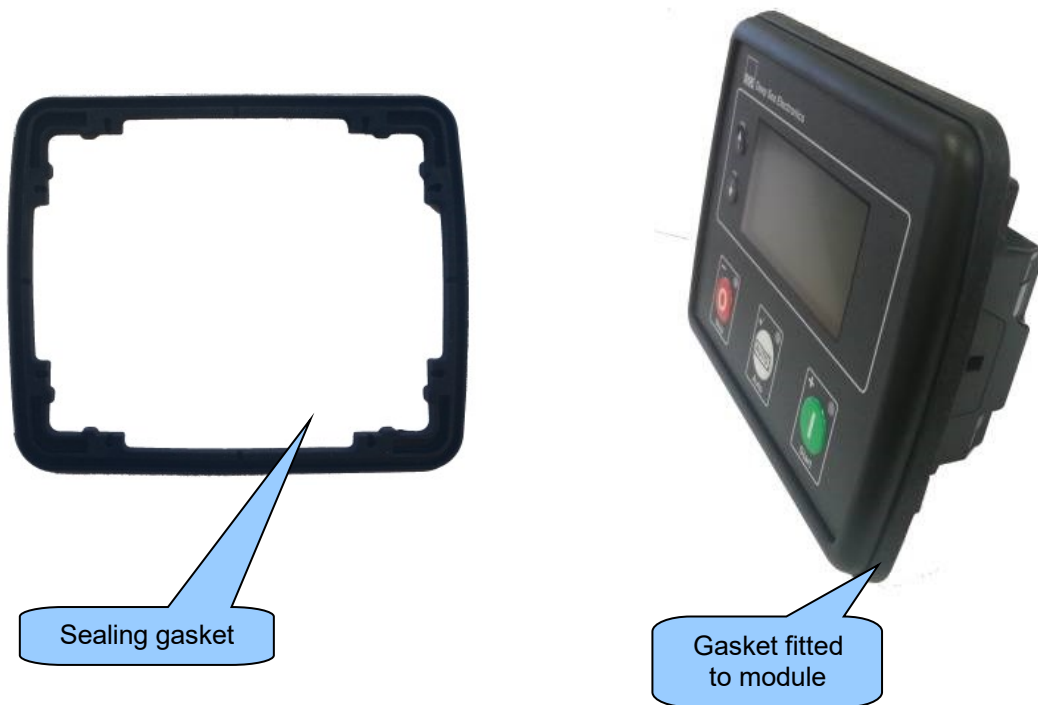

2.15 APPLICABLE STANDARDS

Standard	Description
BS 4884-1	This document conforms to BS4884-1 1992 Specification for presentation of essential information.
BS 4884-2	This document conforms to BS4884-2 1993 Guide to content
BS 4884-3	This document conforms to BS4884-3 1993 Guide to presentation
BS EN 60068-2-1 (Minimum temperature)	-30 °C (-22 °F) -40 °C (-22 °F) with heated screen variant
BS EN 60068-2-2 (Maximum temperature)	+70 °C (158 °F)
BS EN 60068-2-6 (Vibration)	Ten sweeps in each of three major axes 5 Hz to 8 Hz at ± 7.5 mm 8 Hz to 500 Hz at 2 gn
BS EN 60068-2-27 (Shock)	Three shocks in each of three major axes 15 gn in 11 ms
BS EN 60068-2-30 (Damp heat cyclic)	20°C to 55 °C at 95% relative humidity for 48 hours
BS EN 60068-2-78 (Damp heat static)	40 °C at 95% relative humidity for 48 hours
BS EN 60950 (Electrical safety)	Safety of information technology equipment, including electrical business equipment
BS EN 61000-6-2 (Electro-magnetic Compatibility)	EMC Generic Immunity Standard (Industrial)
BS EN 61000-6-4 (Electro-magnetic Compatibility)	EMC Generic Emission Standard (Industrial)
BS EN 60529 (Degrees of protection provided by enclosures)	IP65 (front of module when installed into the control panel with the optional sealing gasket) IP42 (front of module when installed into the control panel WITHOUT being sealed to the panel)
UL508 NEMA rating (Approximate)	12 (Front of module when installed into the control panel with the optional sealing gasket). 2 (Front of module when installed into the control panel WITHOUT being sealed to the panel)
IEEE C37.2 (Standard Electrical Power System Device Function Numbers and Contact Designations)	Under the scope of IEEE 37.2, function numbers can also be used to represent functions in microprocessor devices and software programs. The controller is device number 11L-8000 (Multifunction device protecting Line (generator) –module). As the module is configurable by the generator OEM, the functions covered by the module vary. Depending on module configuration, the device numbers included within the module could be: 2 – Time Delay Starting Or Closing Relay 3 – Checking Or Interlocking Relay 5 – Stopping Device 6 – Starting Circuit Breaker 8 – Control Power Disconnecting Device 10 – Unit Sequence Switch 11 – Multifunction Device 12 – Overspeed Device 14 – Underspeed Device

Continued over the page...

Specification

Standard	Description
IEEE C37.2 (Standard Electrical Power System Device Function Numbers and Contact Designations)	Continued... 26 – Apparatus Thermal Device 27AC – AC Undervoltage Relay 27DC – DC Undervoltage Relay 29 – Isolating Contactor Or Switch 30 – Annunciator Relay 31 – Separate Excitation Device 42 – Running Circuit Breaker 50 – Instantaneous Overcurrent Relay 52 – AC Circuit Breaker 53 – Exciter Or DC Generator Relay 54 – Turning Gear Engaging Device 59AC – AC Overvoltage Relay 59DC – DC Overvoltage Relay 62 – Time Delay Stopping Or Opening Relay 63 – Pressure Switch 71 – Level Switch 74 – Alarm Relay 81 – Frequency Relay 83 – Automatic Selective Control Or Transfer Relay 86 – Lockout Relay

In line with our policy of continual development, Deep Sea Electronics, reserve the right to change specification without notice.

2.15.1 ENCLOSURE CLASSIFICATIONS

2.15.1.1 IP CLASSIFICATIONS

The modules specification under BS EN 60529 Degrees of protection provided by enclosures

IP65 (Front of module when module is installed into the control panel with the optional sealing gasket).
IP42 (front of module when module is installed into the control panel WITHOUT being sealed to the panel)

First Digit	Second Digit
Protection against contact and ingress of solid objects	Protection against ingress of water
0 No protection	0 No protection
1 Protected against ingress solid objects with a diameter of more than 50 mm. No protection against deliberate access, e.g. with a hand, but large surfaces of the body are prevented from approach.	1 Protection against dripping water falling vertically. No harmful effect must be produced (vertically falling drops).
2 Protected against penetration by solid objects with a diameter of more than 12 mm. Fingers or similar objects prevented from approach.	2 Protection against dripping water falling vertically. There must be no harmful effect when the equipment (enclosure) is tilted at an angle up to 15° from its normal position (drops falling at an angle).
3 Protected against ingress of solid objects with a diameter of more than 2.5 mm. Tools, wires etc. with a thickness of more than 2.5 mm are prevented from approach.	3 Protection against water falling at any angle up to 60° from the vertical. There must be no harmful effect (spray water).
4 Protected against ingress of solid objects with a diameter of more than 1 mm. Tools, wires etc. with a thickness of more than 1 mm are prevented from approach.	4 Protection against water splashed against the equipment (enclosure) from any direction. There must be no harmful effect (splashing water).
5 Protected against harmful dust deposits. Ingress of dust is not totally prevented but the dust must not enter in sufficient quantity to interface with satisfactory operation of the equipment. Complete protection against contact.	5 Protection against water projected from a nozzle against the equipment (enclosure) from any direction. There must be no harmful effect (water jet).
6 Protection against ingress of dust (dust tight). Complete protection against contact.	6 Protection against heavy seas or powerful water jets. Water must not enter the equipment (enclosure) in harmful quantities (splashing over).

2.15.1.2 NEMA CLASSIFICATIONS

	NOTE: There is no direct equivalence between IP / NEMA ratings. IP figures shown are approximate only.
---	---

12 (Front of module when module is installed into the control panel with the optional sealing gasket).
2 (Front of module when module is installed into the control panel WITHOUT being sealed to the panel)

1 IP30	Provides a degree of protection against contact with the enclosure equipment and against a limited amount of falling dirt.
2 IP31	Provides a degree of protection against limited amounts of falling water and dirt.
3 IP64	Provides a degree of protection against windblown dust, rain and sleet; undamaged by the formation of ice on the enclosure.
3R IP32	Provides a degree of protection against rain and sleet; undamaged by the formation of ice on the enclosure.
4 (X) IP66	Provides a degree of protection against splashing water, windblown dust and rain, hose directed water; undamaged by the formation of ice on the enclosure. (Resist corrosion).
12/12K IP65	Provides a degree of protection against dust, falling dirt and dripping noncorrosive liquids.
13 IP65	Provides a degree of protection against dust and spraying of water, oil and non-corrosive coolants.

3 INSTALLATION

The module is designed to be mounted on the panel fascia. For dimension and mounting details, see the section entitled *Dimension and Mounting* elsewhere in this document.

3.1 USER CONNECTIONS

NOTE: Availability of some terminals depends upon module version. Full details are given in the section entitled *Terminal Description* elsewhere in this manual.

To aid user connection, icons are used on the rear of the module to help identify terminal functions. An example of this is shown below.

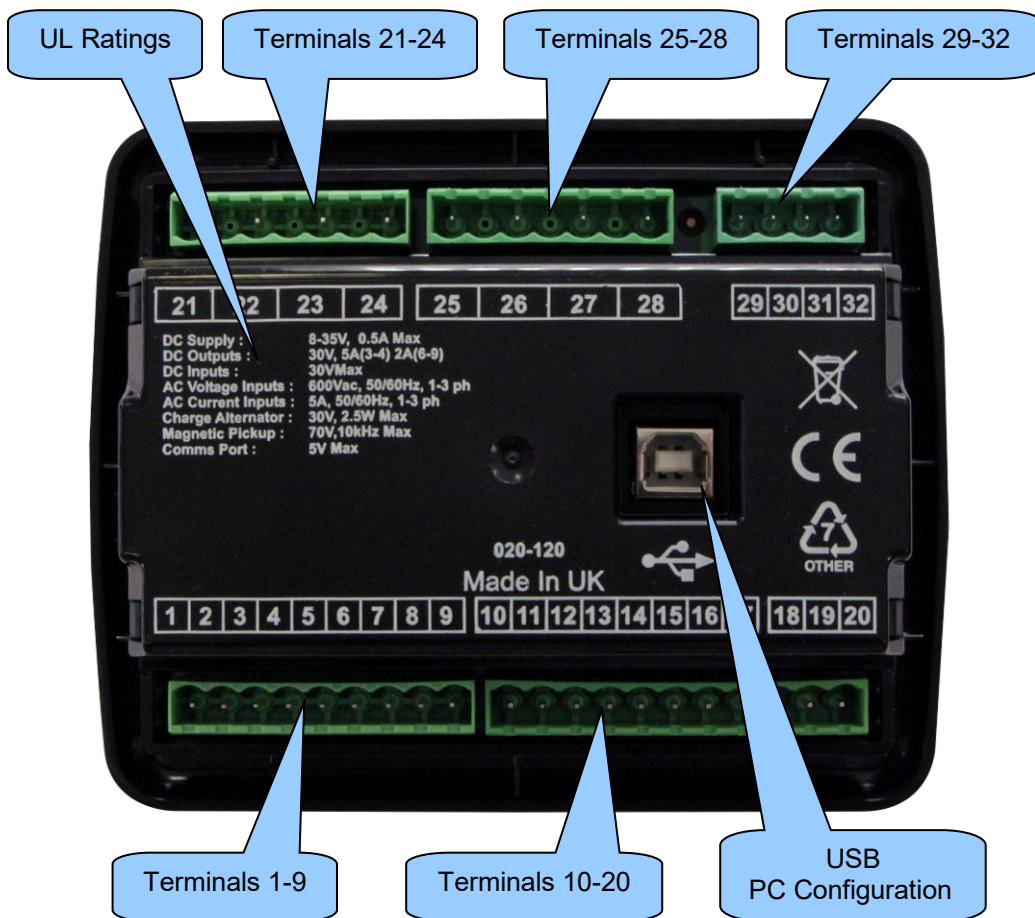

3.2 CONNECTION DESCRIPTIONS

3.2.1 DC SUPPLY, DC OUTPUTS & CHARGE FAIL INPUT

▲ NOTE: When the module is configured for operation with an electronic engine, *Fuel* and *Start* output requirements may be different. For further details on connection to electronic engines, refer to DSE Publication: *057-004 Electronic Engines And DSE Wiring*

▲ NOTE: For further details of module configuration, refer to DSE Publication: *057-258 DSE4510 MKII & DSE4520 MKII Configuration Suite PC Software Manual.*

Pin No	Description	Cable Size	Notes
1	DC Plant Supply Input (Negative)	2.5mm ² AWG 13	
2	DC Plant Supply Input (Positive)	2.5 mm ² AWG 13	Supplies the module and DC Outputs A, B, C, D, E & F
3	DC Output A (FUEL)	2.5mm ² AWG 13	Plant Supply Positive from terminal 2. 10 A for 10 seconds, 5 A resistive continuous Fixed as FUEL relay if electronic engine is not configured.
4	DC Output B (START)	2.5mm ² AWG 13	Plant Supply Positive from terminal 2. 10 A for 10 seconds, 5 A resistive continuous Fixed as START relay if electronic engine is not configured.
5	Charge Fail / Excite	2.5mm ² AWG 13	Do not connect to ground (battery negative). If charge alternator is not fitted, leave this terminal disconnected.
6	DC Output C	1.0mm ² AWG 18	2 Amp rated from module supply.
7	DC Output D	1.0mm ² AWG 18	2 Amp rated from module supply.
8	DC Output E	1.0mm ² AWG 18	2 Amp rated from module supply.
9	DC Output F	1.0mm ² AWG 18	2 Amp rated from module supply as a DC Output. 20 mA at 5 V when configured as sensor supply output.

3.2.2 ANALOGUE SENSOR INPUTS

▲ NOTE: For further details of module configuration, refer to DSE Publication: *057-258 DSE4510 MKII & DSE4520 MKII Configuration Suite PC Software Manual*.

▲ NOTE: It is VERY important that terminal 10 (sensor common) is connected to an earth point on the ENGINE BLOCK, not within the control panel, and must be a sound electrical connection to the sensor bodies. This connection **MUST NOT** be used to provide an earth connection for other terminals or devices. The simplest way to achieve this is to run a **SEPARATE** earth connection from the system earth star point, to terminal 10 directly, and not use this earth for other connections.

▲ NOTE: If PTFE insulating tape is used on the sensor thread when using earth return sensors, ensure not to insulate the entire thread, as this prevents the sensor body from being earthed via the engine block.

Pin No	Description	Cable Size	Notes
10	Sensor Common Return	0.5 mm ² AWG 20	Ground Return Feed For Sensors
11	Analogue Sensor Input A	0.5 mm ² AWG 20	Connect To Oil Pressure Sensor
12	Analogue Sensor Input B	0.5mm ² AWG 20	Connect To Coolant Temperature Sensor
13	Analogue Sensor Input C	0.5 mm ² AWG 20	Connect To Fuel Level Sensor or a Flexible Sensor

3.2.3 CONFIGURABLE DIGITAL INPUTS & CAN

NOTE: For further details of module configuration, refer to DSE Publication: *057-258 DSE4510 MKII & DSE4520 MKII Configuration Suite PC Software Manual.*

NOTE: For further details on connection to electronic engines, refer to DSE Publication: *057-004 Electronic Engines And DSE Wiring*

NOTE: Screened 120 Ω impedance cable specified for use with CAN must be used for the CAN link.
DSE stock and supply Belden cable 9841 which is a high quality 120 Ω impedance cable suitable for CAN use (DSE part number 016-030)

Pin No	Description	Cable Size	Notes
14	Configurable Digital Input A	0.5mm ² AWG 20	Switch to negative
15	Configurable Digital Input B	0.5mm ² AWG 20	Switch to negative
16	Configurable Digital Input C	0.5mm ² AWG 20	Switch to negative
17	Configurable Digital Input D	0.5mm ² AWG 20	Switch to negative
18	CAN Port H	0.5mm ² AWG 20	Use only 120 Ω CAN approved cable
19	CAN Port L	0.5mm ² AWG 20	Use only 120 Ω CAN approved cable
20	CAN Port Screen	Shield	Use only 120 Ω CAN approved cable

3.2.4 GENERATOR & MAINS VOLTAGE & FREQUENCY SENSING

NOTE: The below table describes connections to a three phase, four wire alternator. For alternative wiring topologies, see the section entitled *Alternate Topology Wiring Diagrams* elsewhere in this document.

NOTE: Terminals 25 to 28 are not fitted to DSE4510 MKII

Pin No	Description	Cable Size	Notes
21	Generator L1 (U) Voltage Sensing	1.0 mm ² AWG 18	Connect to Generator L1 (U) output (AC) (Recommend 2 A fuse)
22	Generator L2 (V) Voltage Sensing	1.0 mm ² AWG 18	Connect to Generator L2 (V) output (AC) (Recommend 2 A fuse)
23	Generator L3 (W) Voltage Sensing	1.0 mm ² AWG 18	Connect to Generator L3 (W) output (AC) (Recommend 2 A fuse)
24	Generator Neutral (N) Input	1.0 mm ² AWG 18	Connect to Generator Neutral terminal (AC)
25	Mains L1 (R) Voltage Monitoring	1.0mm ² AWG 18	Connect to Mains L1 (R) output (AC) (Recommend 2A fuse)
26	Mains L2 (S) Voltage Monitoring	1.0mm ² AWG 18	Connect to Mains L2 (S) output (AC) (Recommend 2A fuse)
27	Mains L3 (T) Voltage Monitoring	1.0mm ² AWG 18	Connect to Mains L3 (T) output (AC) (Recommend 2A fuse)
28	Mains Neutral (N) Input	1.0mm ² AWG 18	Connect to Mains Neutral terminal (AC)

3.2.5 CURRENT TRANSFORMERS

 **WARNING!** Do not disconnect this plug when the CTs are carrying current. Disconnection open circuits the secondary of the C.T.'s and dangerous voltages may then develop. Always ensure the CTs are not carrying current and the CTs are short circuit connected before making or breaking connections to the module.

 **NOTE:** The module has a burden of 0.25 VA on the CT. Ensure the CT is rated for the burden of the controller, the cable length being used and any other equipment sharing the CT. If in doubt, consult with the CT supplier.

 **NOTE:** Take care to ensure correct polarity of the CT primary as shown below. If in doubt, consult with the CT supplier.

Pin No	Description	Cable Size	Notes
29	CT Secondary for L1	2.5mm ² AWG 13	Connect to s1 secondary of L1 monitoring CT
30	CT Secondary for L2	2.5mm ² AWG 13	Connect to s1 secondary of L2 monitoring CT
31	CT Secondary for L3	2.5mm ² AWG 13	Connect to s1 secondary of L3 monitoring CT
32	CT Common	2.5mm ² AWG 13	

3.2.5.1 CT CONNECTIONS

p1, κ or K is the primary of the CT that 'points' towards the Generator

p2, ℓ or L is the primary of the CT that 'points' towards the Load

s1 is the secondary of the CT that connects to the DSE Module's input for the CT measuring

s2 is the secondary of the CT that should be commoned with the s2 connections of all the other CTs and connected to the CT common terminal of the module.

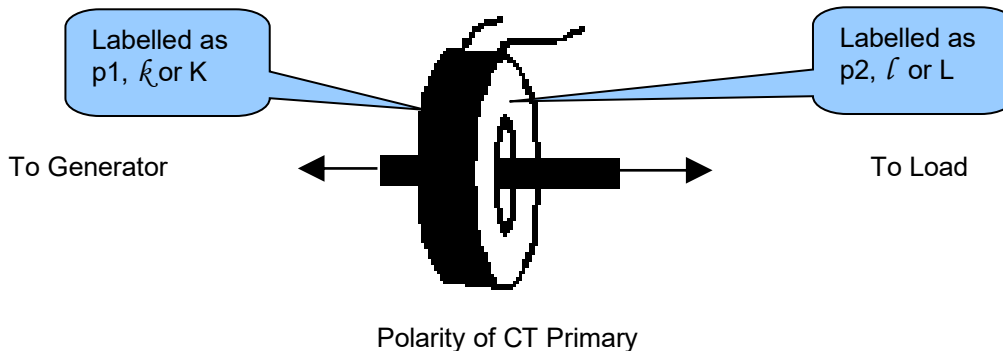



3.2.6 USB SLAVE (PC CONFIGURATION) CONNECTOR

NOTE: The USB connection cable between the PC and the module must not be extended beyond 5 m (yards). For distances over 5 m, it is possible to use a third party USB extender. Typically, they extend USB up to 50 m. The supply and support of this type of equipment is outside the scope of Deep Sea Electronics Ltd.

CAUTION!: Care must be taken not to overload the PC's USB system by connecting more than the recommended number of USB devices to the PC. For further information, consult your PC supplier.

NOTE: For further details of module configuration, refer to DSE Publication: *057-258 DSE4510 MKII & DSE4520 MKII Configuration Suite PC Software Manual*.

	Description	Cable Size	Notes
	Socket for connection to PC with DSE Configuration Suite Software	0.5 mm ² AWG 20	This is a standard USB type A to type B connector. 

3.3 TYPICAL WIRING DIAGRAM

As every system has different requirements, these diagrams show only a typical system and do not intend to show a complete system.

Genset manufacturers and panel builders may use these diagrams as a starting point; however always refer to the completed system diagram provided by the system manufacturer for complete wiring detail.

Further wiring suggestions are available in the following DSE publications, available at www.deepseaelectronics.com to website members.

DSE Part	Description
057-004	Electronic Engines and DSE Wiring
056-005	Using CTs With DSE Products
056-022	Switchgear Control
056-091	Equipotential Earth Bonding
056-092	Best Practices for Wiring Resistive Sensors

3.3.1 DSE4510 MKII TYPICAL WIRING DIAGRAM (3 PHASE 4 WIRE)

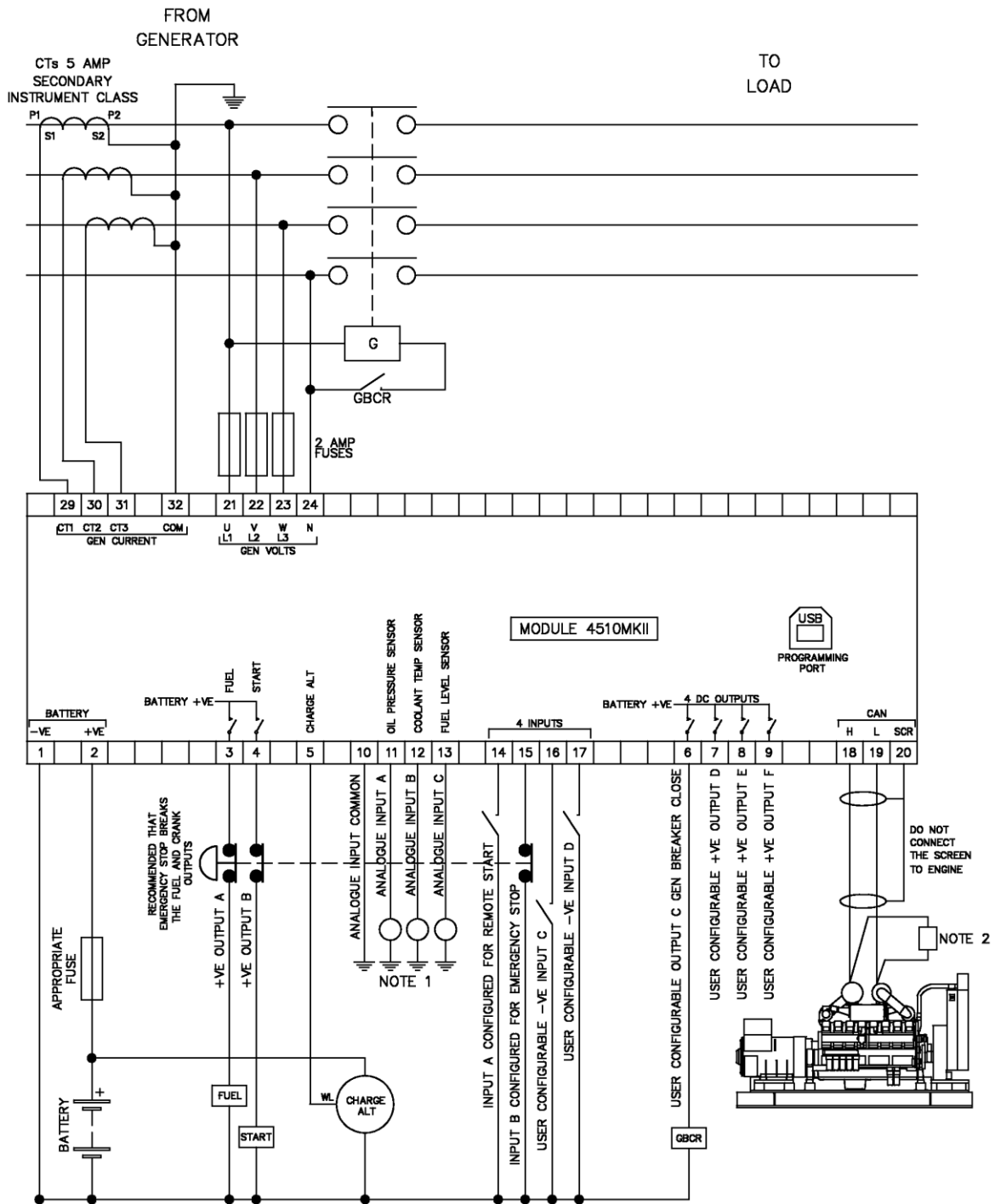

BATTERY NEGATIVE MUST BE GROUNDED

NOTE 1. THESE GROUND CONNECTIONS MUST BE ON THE ENGINE BLOCK, AND MUST BE TO THE SENSOR BODIES.

NOTE 2. 120 R TERMINATING RESISTOR MAY BE REQUIRED EXTERNALLY, SEE ENGINE MANUFACTURERS LITERATURE.

3.3.2 DSE4520 MKII TYPICAL WIRING DIAGRAM (3 PHASE 4 WIRE)

NOTE: It is possible to have a different AC topology for the Mains and Generator supplies. For further details of module configuration, refer to DSE Publication: *057-258 DSE4510 MKII & DSE4520 MKII Configuration Suite PC Software Manual.*

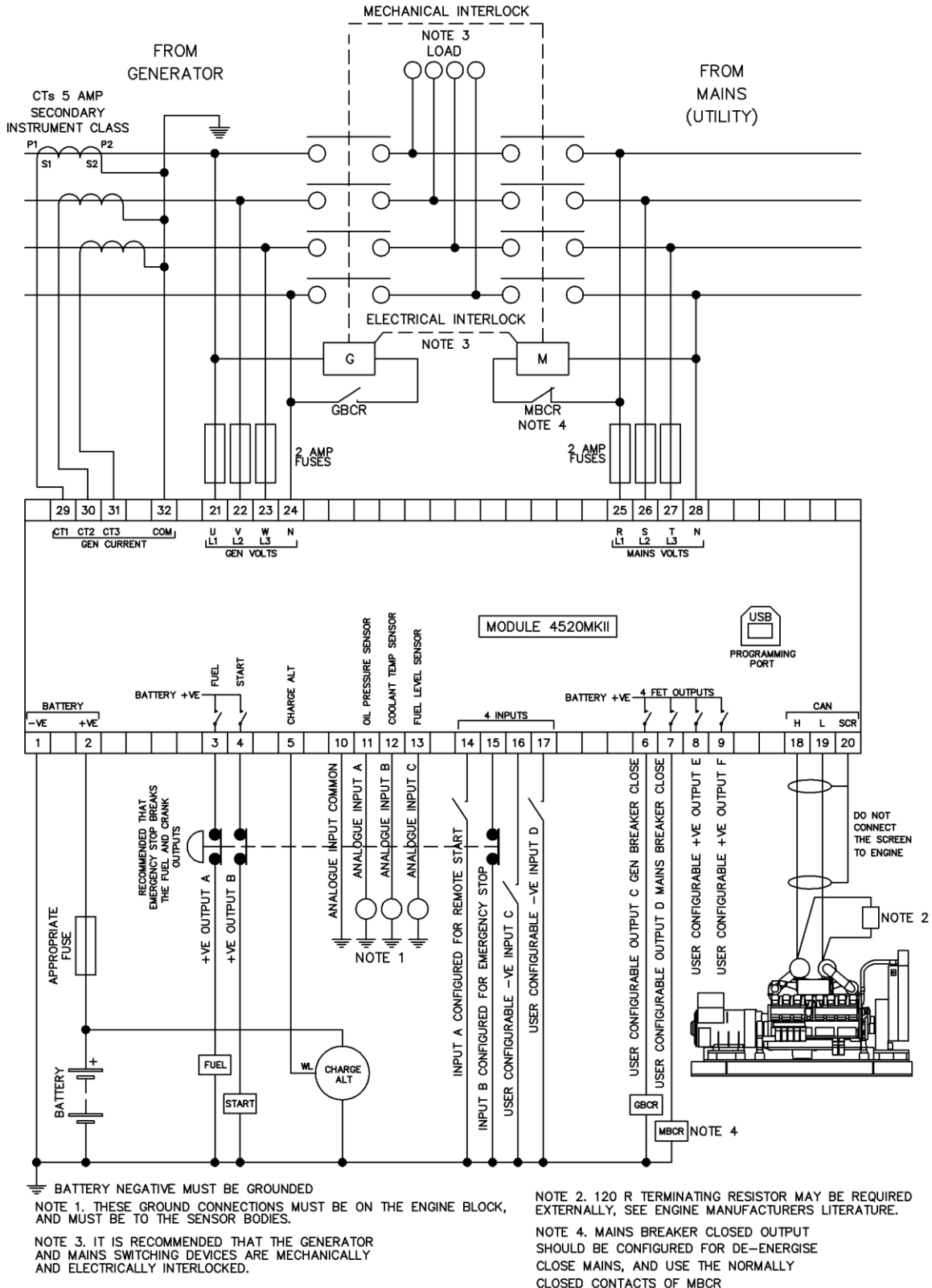

3.3.3 EARTH SYSTEMS

3.3.3.1 NEGATIVE EARTH

The typical wiring diagrams located within this document show connections for a negative earth system (the battery negative connects to Earth).

3.3.3.2 POSITIVE EARTH

When using a DSE module with a Positive Earth System (the battery positive connects to Earth), the following points must be followed:

Follow the typical wiring diagram as normal for all sections **except** the earth points. All points shown as Earth on the typical wiring diagram should connect to **battery negative** (not earth).

3.3.3.3 FLOATING EARTH

Where neither the battery positive nor battery negative terminals are connected to earth the following points must be followed:

Follow the typical wiring diagram as normal for all sections **except** the earth points. All points shown as Earth on the typical wiring diagram should connect to **battery negative** (not earth).

3.3.4 TYPICAL 4 MA TO 20 MA AND 0 V TO 10 V SENSOR WIRING

Typical Wiring For a 4 mA to 20 mA Loop Powered Sensor

NOTE: The 0 V to 10 V and 4 mA to 20 mA selection is only available on the 45xx-004-xx hardware variants.

NOTE: To use a 4 mA to 20 mA sensor, an external 240 Ω shunt resistor must be fitted across terminals 10 and 11. To attain the best possible accuracy, ensure a high accuracy resistor is used.

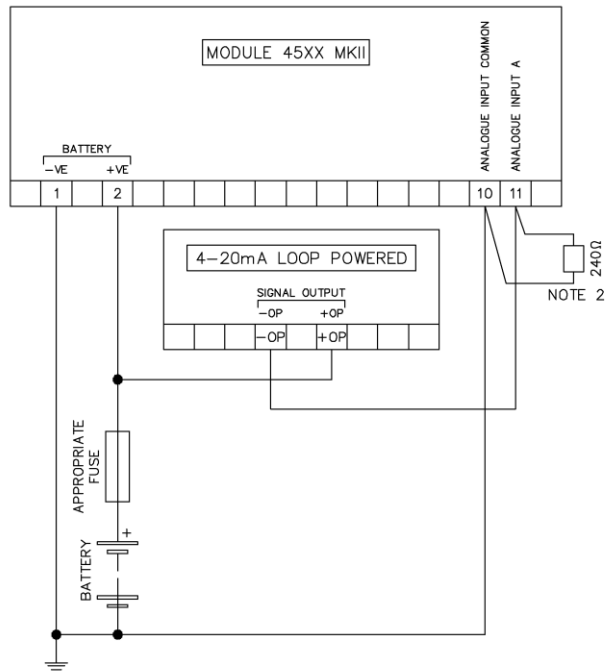

NOTE 1. THESE GROUND CONNECTIONS MUST BE ON THE ENGINE BLOCK, AND MUST BE TO THE SENSOR BODIES.

NOTE 2. WHEN USING A 4-20mA SENSOR, AN EXTERNAL 240Ω RESISTOR MUST BE FITTED ACROSS TERMINALS 10 AND 11.

Typical Wiring For a 4 mA to 20 mA Self Powered Sensor

NOTE: The 0 V to 10 V and 4 mA to 20 mA selection is only available on the 45xx-004-xx hardware variants.

NOTE: To use a 4 mA to 20 mA sensor, an external 240 Ω shunt resistor must be fitted across terminals 10 and 11. To attain the best possible accuracy, ensure a high accuracy resistor is used.

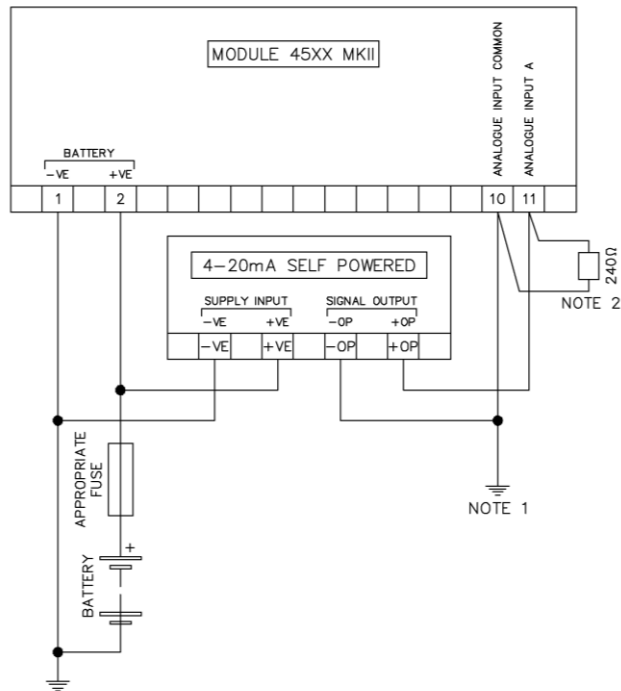

NOTE 1. THESE GROUND CONNECTIONS MUST BE ON THE ENGINE BLOCK, AND MUST BE TO THE SENSOR BODIES.

NOTE 2. WHEN USING A 4-20mA SENSOR, AN EXTERNAL 240Ω RESISTOR MUST BE FITTED ACROSS TERMINALS 10 AND 11.

Typical Wiring For a 0 V to 10 V Self Powered Sensor

NOTE: The 0 V to 10 V and 4 mA to 20 mA selection is only available on the 45xx-004-xx hardware variants.

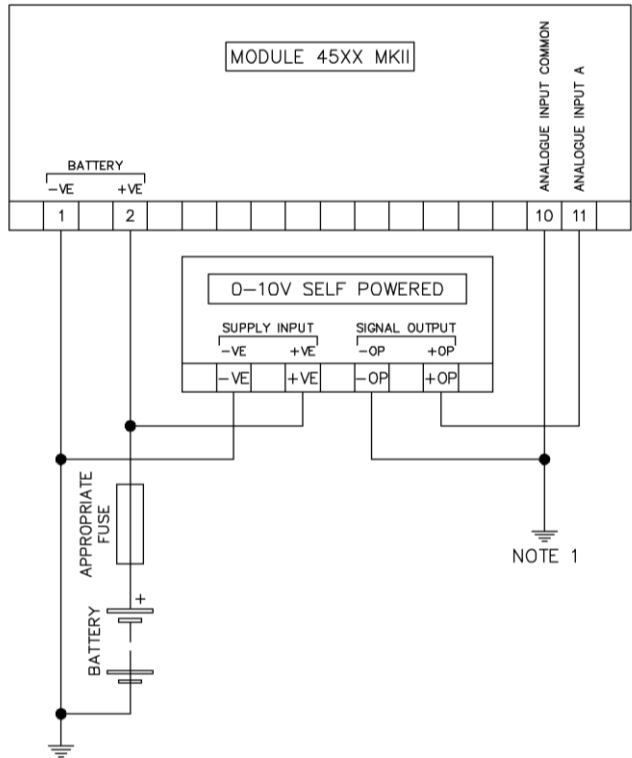

NOTE 1. THESE GROUND CONNECTIONS MUST BE ON THE ENGINE B AND MUST BE TO THE SENSOR BODIES.

Typical Wiring For a Sensor That Requires a 5 V Supply

NOTE: The 5 V sensor supply output selection is only available on the 45xx-xxx-07 product variant.

NOTE: The 0 V to 10 V and 4 mA to 20 mA selection is only available on the 45xx-004-xx hardware variants.

NOTE: The 5 V sensor supply output is available for any type of sensor, a voltage sensor is used in the example below.

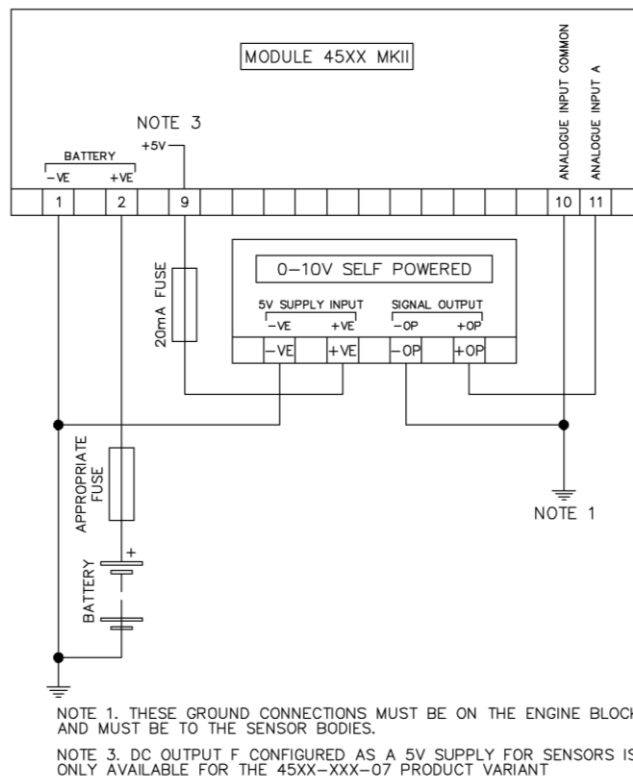

3.4 ALTERNATE TOPOLOGY WIRING DIAGRAMS

3.4.1 GENERATOR

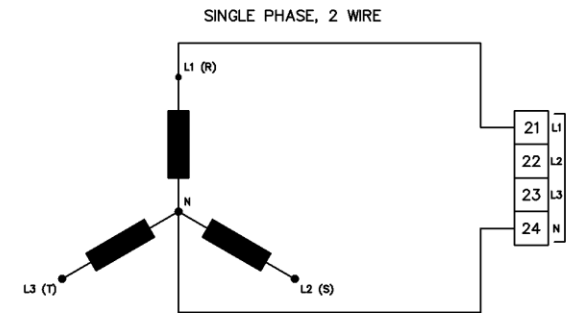
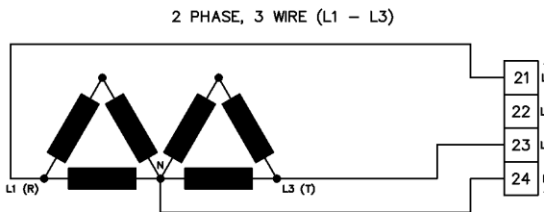
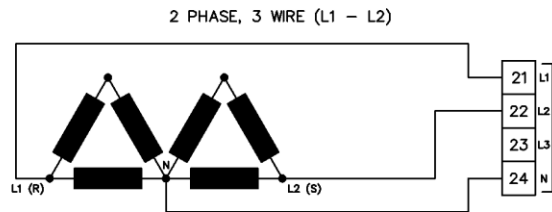
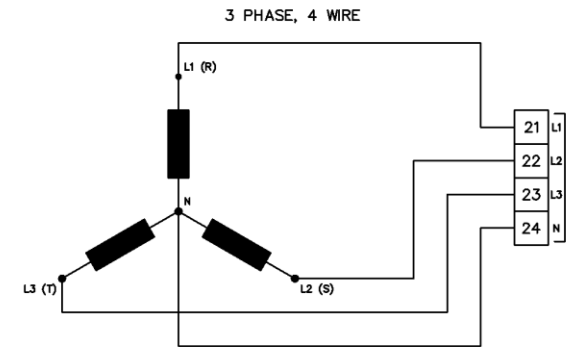
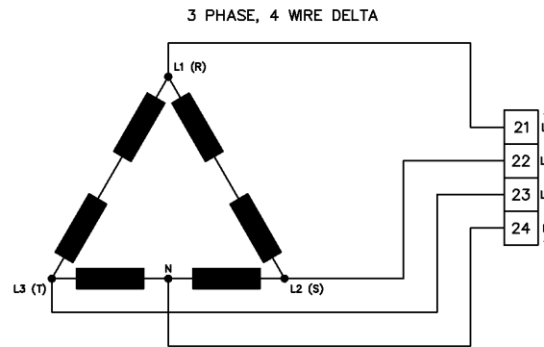
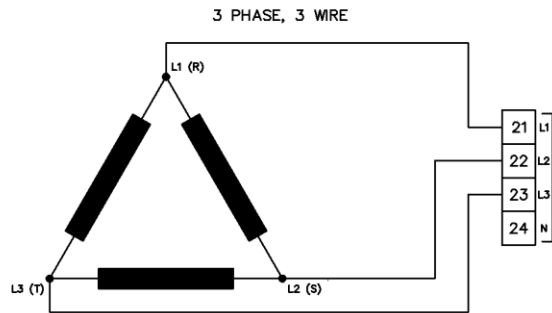



Installation

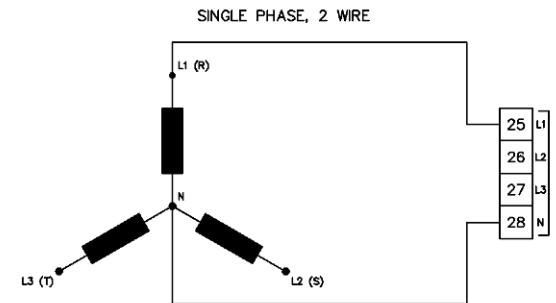
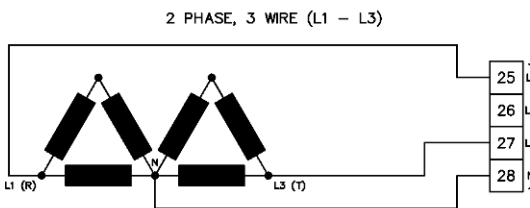
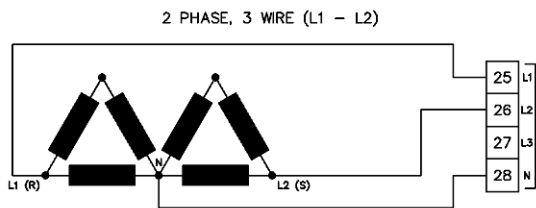
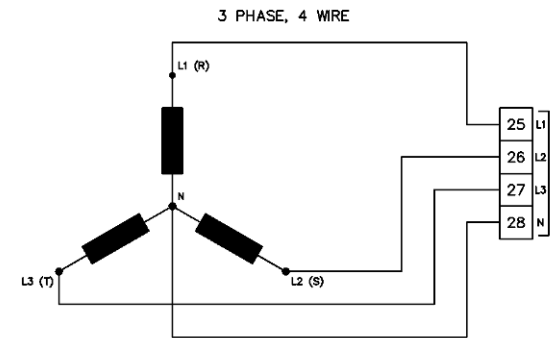
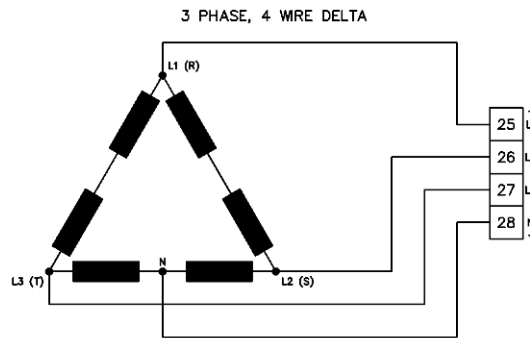
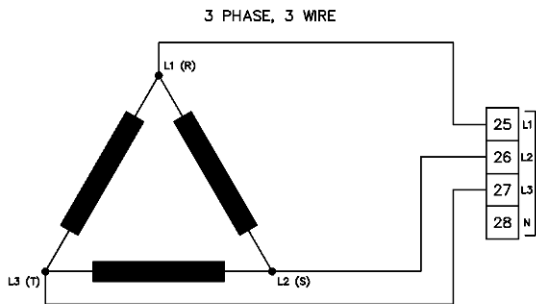

3.4.2 MAINS (DSE4520 MKII ONLY)



4 DESCRIPTION OF CONTROLS

 **CAUTION:** The module may instruct an engine start event due to external influences. Therefore, it is possible for the engine to start at any time without warning. Prior to performing any maintenance on the system, it is recommended that steps are taken to remove the battery and isolate supplies.





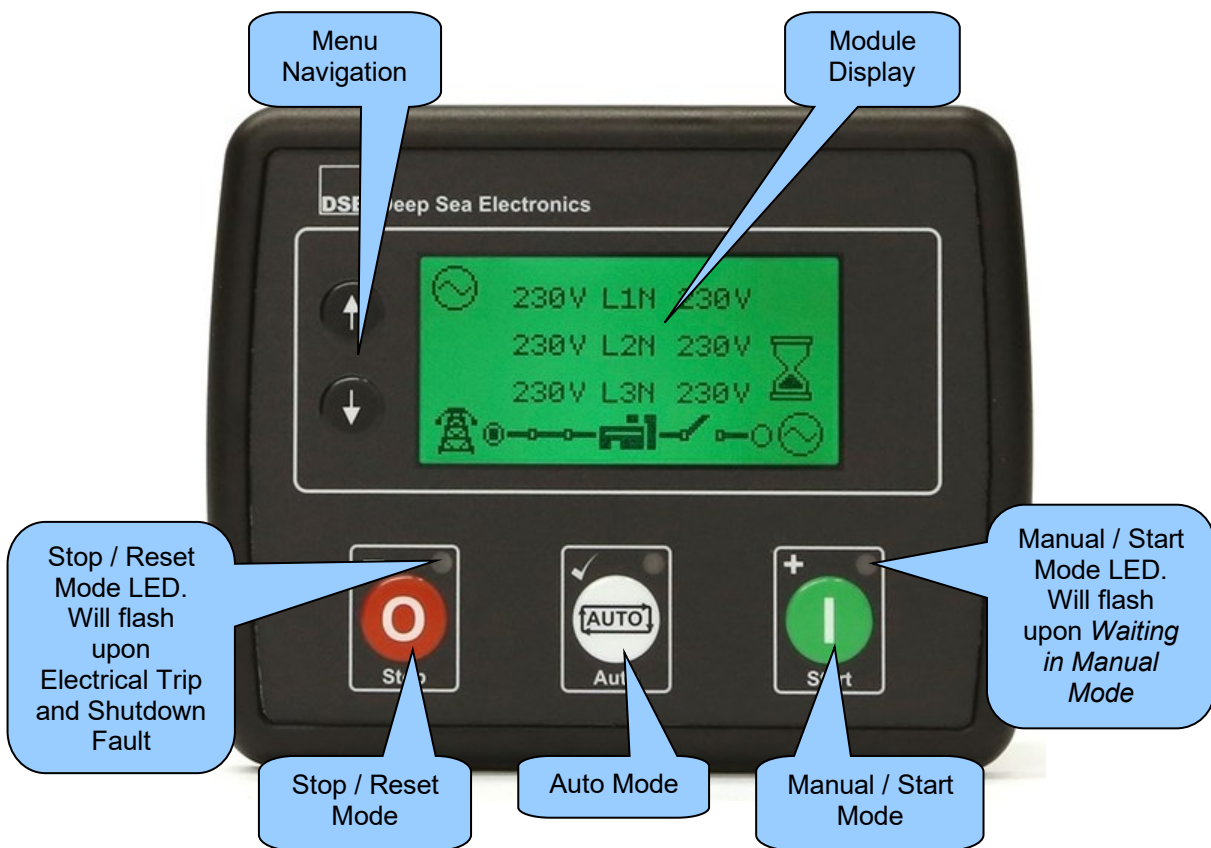

 **NOTE:** The following descriptions detail the sequences followed by a module containing the standard 'factory configuration'. Always refer to your configuration source for the exact sequences and timers observed by any module in the field.

Control of the module is via push buttons mounted on the front of the module with **Stop/Reset Mode** , **Auto Mode**  and **Manual/Start Mode**  functions. For normal operation, these are the only controls which need to be operated. Details of their operation are provided later in this document.









4.1 CONTROL PUSH BUTTONS

 **NOTE:** For further details, see section entitled *Operation* elsewhere in this manual.

Icon	Description
	<p>Stop / Reset Mode</p> <p>This button places the module into its Stop/Reset Mode . This clears any alarm conditions for which the triggering criteria has been removed. If the engine is running and the module is put into Stop/Reset Mode , the module automatically instructs the generator off load ('Close Generator Output' becomes <i>inactive (if used)</i>) and place the mains on load ('Close Mains Output' becomes <i>active (if used on DSE4520 MKII)</i>). The fuel supply de-energises and the engine comes to a standstill. Should any form of <i>start signal</i> be present when in Stop/Reset Mode  the generator remains at rest.</p> <p>For further details, see the more detailed section of <i>Operation</i> elsewhere in this manual.</p>
	<p>Auto Mode</p> <p>This button places the module into its Auto Mode . This mode allows the module to control the function of the generator automatically. The module monitors numerous start requests and when one has been made, the set is automatically started. Once the generator is available, the mains is taken off load ('Close Mains Output' becomes <i>inactive (if used on DSE4520 MKII)</i>) and the generator is placed on load ('Close Generator Output' becomes <i>active (if used)</i> and 'Delayed Load Output 1, 2, 3 & 4' becomes <i>active (if used)</i>).</p> <p>Upon removal of the starting signal, the module starts the <i>Return Delay Timer</i> and once expired, takes the generator off load ('Close Generator Output' becomes <i>inactive (if used)</i> and 'Delayed Load Output 1, 2, 3 & 4' becomes <i>inactive (if used)</i>) and places the mains on load ('Close Mains Output' becomes <i>active (if used on DSE4520 MKII)</i>). The generator then continues to run for the duration of the <i>Cooling Timer</i> until it stops. The module then waits for the next start event.</p> <p>For further details, see the more detailed section of <i>Operation</i> elsewhere in this manual.</p>

 **NOTE:** For further details, see section entitled *Operation* elsewhere in this manual.

Icon	Description
	<p>Manual/Start Mode</p> <p>This button starts the generator and runs it off load. To place the generator on load digital inputs are required to provide the loading/unloading instruction.</p> <p>If the engine is running off-load in Manual/Start Mode  and a <i>Remote Start Signal</i> becomes present, the module automatically instructs the changeover device to take the mains off load ('Close Mains Output' becomes inactive (if used on DSE4520 MKII)) and place the generator on load ('Close Generator Output' becomes active (if used) and 'Delayed Load Output 1, 2, 3 & 4' becomes active (if used)).</p> <p>Upon removal of the <i>Remote Start Signal</i>, the generator remains on load until Stop/Reset Mode  or Auto Mode  are selected.</p> <p>For further details, see the more detailed section of <i>Operation</i> elsewhere in this manual.</p>
 	<p>Menu Navigation</p> <p>Used for navigating the instrumentation, event log and configuration screens.</p>

4.2 MODULE DISPLAY

The module's display contains the following sections. Description of each section can be viewed in the sub sections.

NOTE: Depending upon the module's configuration, some display screens may be disabled. For further details of module configuration, refer to DSE Publication: 057-258 *DSE4510 MKII & DSE4520 MKII Configuration Suite PC Software Manual*.

Inst. Icon	Instrumentation	Unit	Alarm Icon
Active Config	Instrumentation	Unit	
FPE / Auto Run	Instrumentation	Unit	Mode Icon
Load Switching Icons			

Example of DSE4510 MKII Home Page Display

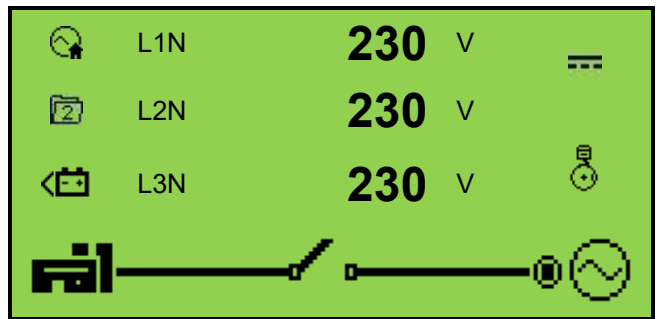



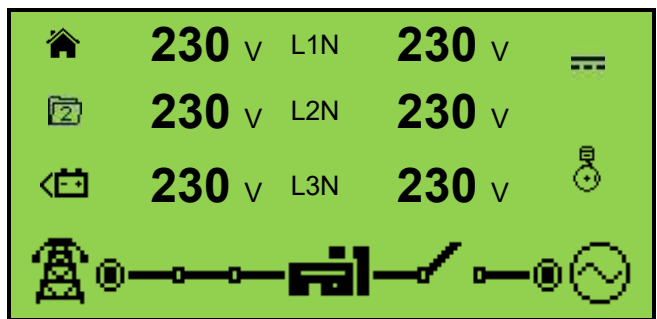



















Example of DSE4520 MKII Home Page Display



4.2.1 INSTRUMENTATION ICONS























NOTE: Depending on module configuration, it is possible to replace some of the icons with text. For further details of module configuration, refer to DSE Publication: *057-258 DSE4510 MKII & DSE4520 MKII Configuration Suite PC Software Manual*.

When viewing instrumentation pages, an icon is displayed in the *Inst. Icon* section to indicate what section is currently being displayed.

Icon	Text	Details
		The default home page which displays generator voltage and mains voltage (DSE4520 MKII only) or engine tier 4 information
		Generator and mains voltage (DSE4520 MKII only)
		Generator voltage and frequency instrumentation screen
		Mains voltage and frequency instrumentation screen (DSE4520 MKII only)
		Generator current instrumentation screen
		Mains current instrumentation screen (DSE4520 MKII only when CT in load location)
		Load power instrumentation screen
		Engine speed instrumentation screen
	Run Time	Hours run instrumentation screen
		Battery voltage instrumentation screen
	Oil Press.	Oil pressure instrumentation screen
		Coolant level screen
	Eng. Temp.	Coolant temperature instrumentation screen
		Flexible sensor instrumentation screen
		Appears when the event log is being displayed
		Current time held in the unit
		The current value of the scheduler run time and duration
		ECU diagnostic trouble codes
		Oil filter maintenance timers
		Air filter maintenance timers
		Fuel filter maintenance timers
		Engine oil temperature (measured from CAN) instrumentation screen
		Inlet manifold temperature (measured from CAN) instrumentation screen





Continued overleaf...

Description of Controls

Icon	Details
	Exhaust temperature 1 (measured from CAN) instrumentation screen
	Exhaust temperature 2 (measured from CAN) instrumentation screen
	Coolant pressure 1 (measured from CAN) instrumentation screen
	Coolant pressure 2 (measured from CAN) instrumentation screen
	Turbo pressure 1 (measured from CAN) instrumentation screen
	Turbo pressure 2 (measured from CAN) instrumentation screen
	Fuel consumption (measured from CAN) instrumentation screen
	Fuel pressure (measured from CAN) instrumentation screen
	Total fuel used (measured from CAN) instrumentation screen
	Fuel level instrumentation screen
	Soot level as a percentage (measured from CAN) instrumentation screen
	Ash level as a % (measured from CAN) instrumentation screen
	DEF tank level (measured from CAN) instrumentation screen
	DEF fluid temperature (measured from CAN) instrumentation screen
	DEF consumption (measured from CAN) instrumentation screen
	String of text for DEF inducement reason (taken from CAN)
	String of text for DEF inducement severity (taken from CAN)
	EGR pressure (measured from CAN) instrumentation screen
	EGR temperature (measured from CAN) instrumentation screen
	Ambient air temperature (measured from CAN) instrumentation screen
	Air intake temperature (measured from CAN) instrumentation screen
	Configurable received CAN instrumentation screens 1 to 10

4.2.2 ACTIVE CONFIGURATION





An icon is displayed in the **Active Config** section to indicate the active configuration within the currently selected within the controller.

Icon	Details
	Appears when the main configuration is selected.
	Appears when the alternative configuration 1 is selected.
	Appears when the alternative configuration 2 is selected.
	Appears when the alternative configuration 3 is selected.

4.2.3 FRONT PANEL EDITOR (FPE) / AUTO RUN ICON

NOTE: For further details about the Front Panel Editor, see the section entitled 'Front Panel Editor' elsewhere in this manual.

When running in Auto Mode and on the Home () page, an icon is displayed in the **FPE / Auto Run** section to indicate the source of the auto start signal.

Icon	Auto Run Reason
	Appears when a remote start input is active
	Appears when a low battery run is active
	Appears when a mains failure start request is active
	Appears when a scheduled run is active

4.2.4 MODE ICON

NOTE: Depending on module configuration, it is possible to replace some of the icons with text. For further details of module configuration, refer to DSE Publication: *057-258 DSE4510 MKII & DSE4520 MKII Configuration Suite PC Software Manual*.

An icon is displayed in the **Mode Icon** section to indicate the mode the controller is currently in.

Icon	Text	Details
	Stop	Appears when the engine is at rest and the unit is in Stop/Reset Mode
	Auto	Appears when the engine is at rest and the unit is in Auto Mode
	Man.	Appears when the engine is at rest and the unit is waiting for a Manual/Start
		Appears when the engine is at rest and the periodic ECU wake up is active.
		Appears when a timer is active, for example cranking time, crank rest etc.
		Appears when the engine is running, and all timers have expired, either on or off load. The animation speed is reduced when running in idle mode.
		Appears when the unit is in the front panel editor.

4.2.5 LOAD SWITCHING ICON



NOTE: It is possible to remove the **Load Switching Icons** from the module's fascia. For further details of module configuration, refer to DSE Publication: *057-258 DSE4510 MKII & DSE4520 MKII Configuration Suite PC Software Manual*.

An icon is displayed in the **Load Switching Icon** section to indicate the current operation status of the controller.

Icon	Details
	Appears when the generator is at rest or not available and when the generator breaker is open.
	Appears when the generator is at rest or not available and the generator breaker has failed to open.
	Appears when the generator is available, and the generator breaker is open.
	Appears when the generator is available, and the generator breaker is closed.
	Appears when the mains supply is not available, and the mains breaker is open. (DSE4520 MKII Only)
	Appears when the mains supply is not available, and the mains breaker is closed. (DSE4520 MKII Only)
	Appears when the mains supply is available, and the mains breaker is open. (DSE4520 MKII Only)
	Appears when the mains supply is available, and the mains breaker is closed. (DSE4520 MKII Only)

4.2.6 SPLASH SCREEN

An icon is displayed across the entire screen to indicate the when the configuration of the module is changed.

Icon	Details
	Appears when a USB connection is made to the controller.
	Appears if either the configuration file or engine file becomes corrupted.

4.2.7 BACKLIGHT

NOTE: It is possible to turn of the LCB backlight after a period of inactivity. For further details of module configuration, refer to DSE Publication: *057-258 DSE4510 MKII & DSE4520 MKII Configuration Suite PC Software Manual*.

The LCD backlight is on if the unit has sufficient voltage while the unit is turned on unless the unit is cranking for which the backlight is turned off.

The unit supports an option for turning the LCD backlight off after a period without user interaction. The backlight may turn off during a time of inactivity when no facia control button is pressed. The backlight turns on again when a button is pressed.

Example of configuration to enable the LCD backlight to turn off after 1 minute of inactivity on the module's facia buttons:

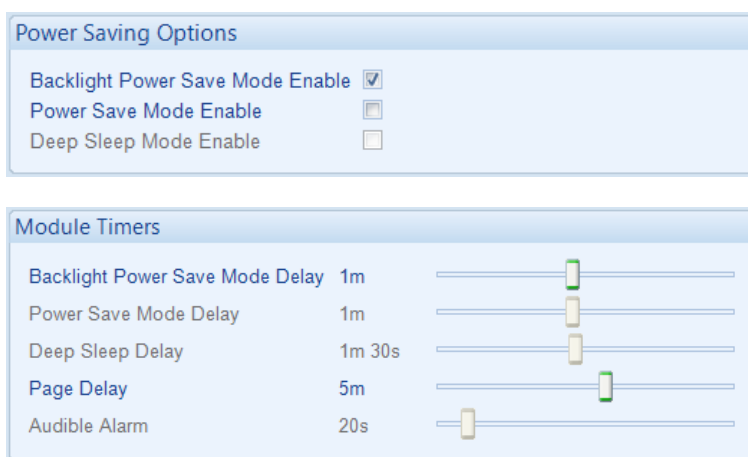

4.2.8 ALARM ICONS (PROTECTIONS)

An icon is displayed in the **Alarm Icon** section to indicate the alarm that is current active on the controller.

In the event of a warning alarm, the LCD only displays the **Alarm Icon**. In the event of an electrical trip or shutdown alarm, the module displays the **Alarm Icon** and the **Stop/Reset Mode**  button LED begins to flash.

If multiple alarms are active at the same time, the **Alarm Icon** automatically cycles through all the appropriate icons to indicate each alarm which is active.

Example:

If the DSE controller was sensing a charge alternator failure alarm, delay over current alarm and an AC under voltage alarm at the same time, it would cycle through all the icons to show this.

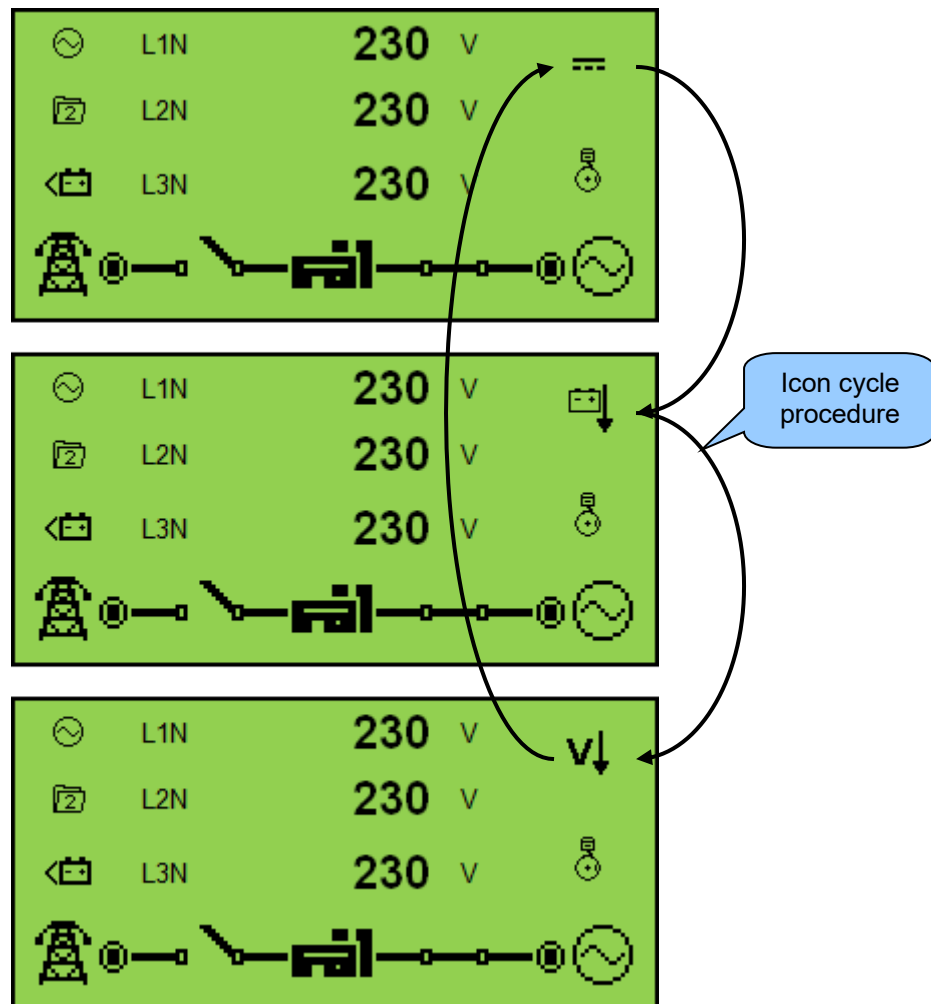















4.2.8.1 WARNING ALARM ICONS

NOTE: It is possible for the module to have customised alarm icons which are not listed within this document. For further information on the meaning of these customised alarm icons, contact the generator supplier.

NOTE: Depending on module configuration, it is possible to replace the alarm icons with text. For further details of module configuration, refer to DSE Publication: *057-258 DSE4510 MKII & DSE4520 MKII Configuration Suite PC Software Manual*.



















Warnings are non-critical alarm conditions and do not affect the operation of the engine system, they serve to draw the operator's attention to an undesirable condition.

By default, warning alarms are self-resetting when the fault condition is removed. However, enabling *All Warnings Are Latched* causes warning alarms to latch until reset manually. This is enabled using the DSE Configuration Suite in conjunction with a compatible PC.

Icon	Text	Fault	Description
	Dig. Input A	Auxiliary Inputs	The module detects that an auxiliary input which has been user configured to create a fault condition has become active.
	Ana. Input A	Analogue Input Configured As Digital	The analogue inputs can be configured to digital inputs. The module detects that an input configured to create a fault condition has become active.
	Ana. Input A High	Analogue Input High	The module detects that an analogue input has risen above the high pre-alarm setting level.
	Ana. Input A Low	Analogue Input Low	The module detects that an analogue input has fallen below the low pre-alarm setting level.
	Fail to Stop	Fail To Stop	The module has detected a condition that indicates that the engine is running when it has been instructed to stop. NOTE: 'Fail to Stop' could indicate a faulty oil pressure sensor. If engine is at rest check oil sensor wiring and configuration.
	Fan Spd. Low	Fan Speed Low	The module has detected that the cooling fan speed is too low.
	High Eng. Temp.	Engine High Temperature	The module detects that the engine coolant temperature has exceeded the high engine temperature pre-alarm setting level after the Safety On timer has expired.
	Chrg. Alt. Fail	Charge Failure	The auxiliary charge alternator voltage is low as measured from the W/L terminal.
	Low Fuel	Low Fuel Level	The level detected by the fuel level sensor is below the low fuel level pre-set pre-alarm setting.
	High Fuel	High Fuel Level	The level detected by the fuel level sensor is above the high fuel level pre-set pre-alarm setting.
	Batt. Und. Volt.	Battery Under Voltage	The DC supply has fallen below or risen above the low volts pre-set pre-alarm setting.
	Batt. Over Volt.	Battery Over Voltage	The DC supply has risen above the high volts pre-set pre-alarm setting.
	Gen. Und. Volt.	Generator Under Voltage	The generator output voltage has fallen below the pre-set pre-alarm setting after the Safety On timer has expired.
	Gen. Over Volt.	Generator Over Voltage	The generator output voltage has risen above the pre-set pre-alarm setting.

Continued overleaf...

Description of Controls

Icon	Text	Fault	Description
	Gen. Und. Freq.	Generator Under Frequency	The generator output frequency has fallen below the pre-set pre-alarm setting after the Safety On timer has expired.
	Gen. Over Freq.	Generator Over Frequency	The generator output frequency has risen above the pre-set pre-alarm setting.
	CAN ECU Fault	CAN ECU Fault	The engine ECU has detected an alarm
	CAN Data Fail	CAN Data Fail	The module is configured for CAN operation and does not detect data on the engine Can data link.
	Imm. O.C.	Immediate Over Current	The measured current has risen above the configured trip level.
	Del. O.C.	Delayed Over Current	The measured current has risen above the configured trip level for a configured duration.
	KW Overl.	kW Overload	The measured kW has risen above the configured trip level for a configured duration.
	Oil Filter Maint.	Oil Filter Maintenance Alarm	Maintenance due for oil filter.
	Air Filter Maint.	Air Filter Maintenance Alarm	Maintenance due for air filter
	Fuel Filter Maint.	Fuel Filter Maintenance Alarm	Maintenance due for fuel filter.
	Water In Fuel	Water In Fuel	The module or engine ECU has detected there is water in the fuel.
		Fuel Usage Alarm	The module has detected that the fuel consumption is higher than expected.
	DPF	DPTC Filter	The engine ECU has detected that the DPF regen is required. Contact the engine manufacturer for further details.
	DEF Low	DEF Level	The engine ECU has detected that the DEF level is low.
	SCR Ind.	SCR Inducement	The engine ECU has detected that there is a fault with the SCR system. Contact the engine manufacturer for further details.
	High Eng. Temp.	HEST Active	The engine ECU has detected that exhaust gas recirculation temperature is high.
	Bund Level High	Tank Bund Level High	The module has detected that the fuel has leaked in the bund of the fuel tank.
		Coolant Level Alarm	The coolant level has been detected as low.

4.2.8.2 ELECTRICAL TRIP ALARM ICONS









NOTE: It is possible for the module to have customised alarm icons which are not listed within this document. For further information on the meaning of these customised alarm icons, contact the generator supplier.

NOTE: The fault condition must be resolved before the alarm can be reset. If the fault condition remains, it is not possible to reset the alarm (the exception to this is the *Coolant Temp High* alarm and similar *Active From Safety On* alarms, as the coolant temperature could be high with the engine at rest).

NOTE: Depending on module configuration, it is possible to replace the alarm icons with text. For further details of module configuration, refer to DSE Publication: *057-258 DSE4510 MKII & DSE4520 MKII Configuration Suite PC Software Manual*.









Electrical Trip Alarms are latching and stop the Generator but in a controlled manner. On initiation of the electrical trip condition the module de-activates the **Close Gen Output** outputs to remove the load from the generator. Once this has occurred the module starts the *Cooling Timer* and allows the engine to cool off-load before shutting down the engine. To restart the generator the fault must be cleared, and the alarm reset.

Electrical Trip Alarms are latching alarms and to remove the fault, press the **Stop/Reset Mode**  button on the module.

Icon	Text	Fault	Description
	Dig. Input A	Auxiliary Inputs	The module detects that an auxiliary input which has been user configured to create a fault condition has become active.
	Ana. Input A	Analogue Input Configured As Digital	The analogue inputs can be configured to digital inputs. The module detects that an input configured to create a fault condition has become active.
	Ana. Input A High	Analogue Input High	The module detects that an analogue input has risen above the high alarm setting level.
	Ana. Input A Low	Analogue Input Low	The module detects that an analogue input has fallen below the low alarm setting level.
	Ana. Input A O.C.	Analogue Input Open Circuit	The analogue input has been detected as being open circuit.
	Low Fuel	Low Fuel Level	The level detected by the fuel level sensor is below the low fuel level pre-set alarm setting.
	High Fuel	High Fuel Level	The level detected by the fuel level sensor is above the high fuel level pre-set alarm setting.
	Del. O.C.	Delayed Over Current	The measured current has risen above the configured trip level for a configured duration.
	kW Overl.	kW Overload	The measured kW has risen above the configured trip level for a configured duration.

Continued overleaf...

Description of Controls

Icon	Text	Fault	Description
	Water In Fuel	Water In Fuel	The module or engine ECU has detected there is water in the fuel.
		Fuel Usage Alarm	The module has detected that the fuel consumption is higher than expected.
	DPF	DPTC Filter	The engine ECU has detected that the DPF regen is required. Contact the engine manufacturer for further details.
	DEF Low	DEF Level	The engine ECU has detected that the DEF level is low.
	SCR Ind.	SCR Inducement	The engine ECU has detected that there is a fault with the SCR system. Contact the engine manufacturer for further details.
	DEF Low	Fan Speed Low	The module has detected that the cooling fan speed is too low.
	Bund Level High	Tank Bund Level High	The module has detected that the fuel has leaked in the bund of the fuel tank.
		Coolant Level Alarm	The coolant level has been detected as low.

4.2.8.3 SHUTDOWN ALARM ICONS













NOTE: It is possible for the module to have customised alarm icons which are not listed within this document. For further information on the meaning of these customised alarm icons, contact the generator supplier.

NOTE: The fault condition must be resolved before the alarm can be reset. If the fault condition remains, it is not possible to reset the alarm (the exception to this is the *Oil Pressure Low* alarm and similar *Active From Safety On* alarms, as the oil pressure is low with the engine at rest).

NOTE: Depending on module configuration, it is possible to replace the alarm icons with text. For further details of module configuration, refer to DSE Publication: *057-258 DSE4510 MKII & DSE4520 MKII Configuration Suite PC Software Manual*.



















Shutdown Alarms are latching and immediately stop the Generator. On initiation of the shutdown condition the module de-activates the **Close Gen Output** outputs to remove the load from the generator. Once this has occurred, the module shuts the generator set down immediately to prevent further damage. To restart the generator the fault must be cleared, and the alarm reset.

Shutdown Alarms are latching alarms and to remove the fault, press the **Stop/Reset Mode**  button on the module.

Icon	Text	Fault	Description
	Dig. Input A	Auxiliary Inputs	The module detects that an auxiliary input which has been user configured to create a fault condition has become active.
	Ana. Input A	Analogue Input Configured As Digital	The analogue inputs can be configured to digital inputs. The module detects that an input configured to create a fault condition has become active.
	Ana. Input A High	Analogue Input High	The module detects that an analogue input has risen above the high alarm setting level.
	Ana. Input A Low	Analogue Input Low	The module detects that an analogue input has fallen below the low alarm setting level.
	Ana. Input A O.C.	Analogue Input Open Circuit	The analogue input has been detected as being open circuit.
	Fail to Start	Fail To Start	The engine has failed to start after the configured number of start attempts
	Low Oil Pres.	Low Oil Pressure	The module detects that the engine oil pressure has fallen below the low oil pressure pre-alarm setting level after the Safety On timer has expired.
	High Eng. Temp.	Engine High Temperature	The module detects that the engine coolant temperature has exceeded the high engine temperature pre-alarm setting level after the Safety On timer has expired.
	Und. Spd.	Under Speed	The engine speed has fallen below the under speed pre alarm setting
	Over Spd.	Over Speed	The engine speed has risen above the over speed pre alarm setting
	Chrg. Alt. Fail	Charge Failure	The auxiliary charge alternator voltage is low as measured from the W/L terminal.
	Fan Spd. Low	Fan Speed Low	The module detected that the cooling fan speed is too low.







Continued overleaf...

Description of Controls

Icon	Text	Fault	Description
	Low Fuel	Low Fuel Level	The level detected by the fuel level sensor is below the low fuel level pre-set alarm setting.
	High Fuel	High Fuel Level	The level detected by the fuel level sensor is above the high fuel level pre-set alarm setting.
	Gen. Und. Volt.	Generator Under Voltage	The generator output voltage has fallen below the pre-set alarm setting after the Safety On timer has expired.
	Gen. Over Volt.	Generator Over Voltage	The generator output voltage has risen above the pre-set alarm setting.
	Gen. Und. Freq.	Generator Under Frequency	The generator output frequency has fallen below the pre-set alarm setting after the Safety On timer has expired.
	Gen. Over Freq.	Generator Over Frequency	The generator output frequency has risen above the pre-set alarm setting.
	Del. O.C.	Delayed Over Current	The measured current has risen above the configured trip level for a configured duration.
	KW Overl.	kW Overload	The measured kW has risen above the configured trip level for a configured duration.
	CAN ECU Fault	CAN ECU Fault	The engine ECU has detected an alarm – CHECK ENGINE LIGHT Contact Engine Manufacturer for support.
	CAN Data Fail	CAN Data Fail	The module is configured for CAN operation and does not detect data on the engine Can data link.
	E. Stop	Emergency Stop	The emergency stop button has been pressed. This is normally a failsafe (normally closed to emergency stop) input and immediately stops the set should the signal be removed.
	Oil Sense O.C.	Oil Sensor Open Circuit	The oil pressure sensor has been detected as being open circuit.
	Cool Sense O.C.	Coolant Temperature Sensor Open Circuit	The coolant temperature sensor has been detected as being open circuit.
		Coolant Level Sensor Open Circuit	The coolant level sensor has been detected as being open circuit.
		Coolant Level Alarm	The coolant level has been detected as low.
	Oil Filter Maint.	Oil Filter Maintenance Alarm	Maintenance due for oil filter.
	Air Filter Maint.	Air Filter Maintenance Alarm	Maintenance due for air filter
	Fuel Filter Maint.	Fuel Filter Maintenance Alarm	Maintenance due for fuel filter.

Continued overleaf...

Description of Controls



Icon	Text	Fault	Description
	Water In Fuel	Water In Fuel	The module or engine ECU has detected there is water in the fuel.
		Fuel Usage Alarm	The module has detected that the fuel consumption is higher than expected.
	DPF	DPTC Filter	The engine ECU has detected that the DPF regen is required. Contact the engine manufacturer for further details.
	DEF Low	DEF Level	The engine ECU has detected that the DEF level is low.
	SCR Ind.	SCR Inducement	The engine ECU has detected that there is a fault with the SCR system. Contact the engine manufacturer for further details.
	Bund Level High	Tank Bund Level High	The module has detected that the fuel has leaked in the bund of the fuel tank.

4.3 VIEWING THE INSTRUMENT PAGES



4.3.1 NAVIGATION MENU

To enter the navigation menu, press both the  (up) and  (down) buttons simultaneously.



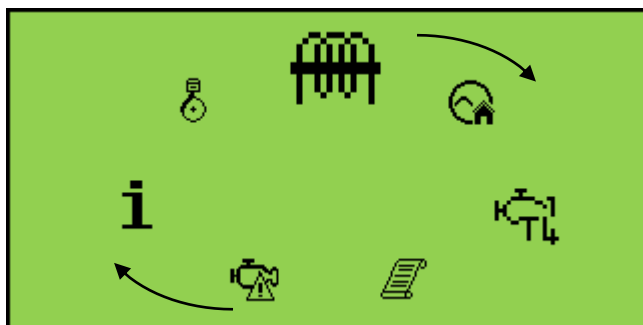







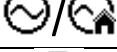

To select the required icon, press the  (up) button to cycle right or the  (down) button to cycle left until the desired instrumentation section is reached.





Once the desired icon is at the top, press the **Auto Mode**  (✓) button to enter that instrumentation section. If the **Auto Mode**  (✓) button is not pressed, the display automatically returns to the Home  page after the configured setting of the *LCD Scroll Timer*.

4.3.1.1 NAVIGATION MENU ICONS

Icon	Description
	Home page (either engine tier 4 or generator and voltage instrumentation, depending upon module configuration)
	Generator and mains voltage instrumentation
	Generator instrumentation
	Mains instrumentation (DSE4520 MKII only)
	Mains load instrumentation
	Current and load instrumentation
	Engine instrumentation
	Module information
	Engine DTCs (Diagnostic Trouble Codes) if active
	Event Log
	Engine Tier 4 information

4.3.2 GENERAL NAVIGATION



NOTE: For further details of module configuration, refer to DSE Publication: 057-258 *DSE4510 MKII & DSE4520 MKII Configuration Suite PC Software Manual*.



It is possible to scroll through the display to view different pages of information by repeatedly operating the up  or down  navigation buttons.

If you want to view one of the instrument pages towards the end of the list, it may be quicker to scroll up through the pages rather than down!

Example:



And so on until the last page is reached. A Further press of the down  button returns the display to the Home (/ ) page.

Once selected, the page will remain on the LCD display until the user selects a different page or, after an extended period of inactivity (*Page Delay Timer*), the module reverts to the Home (/ ) page.

The *Page Delay Timer* is configurable using the DSE Configuration Suite Software or by using the Front Panel Editor.

Timer Name	Current Value
Power Save Mode Delay	1m
Deep Sleep Delay	1m 30s
Page Delay	5m

4.3.3 HOME

NOTE: Depending upon the module's configuration, the home screen may be set to display electrical parameters or engine tier 4 information. For further details of module configuration, refer to DSE Publication: 057-258 *DSE4510 MKII & DSE4520 MKII Configuration Suite PC Software Manual*.

This is the page that is displayed when no other page has been selected and is automatically displayed after a period of inactivity (*Page Delay Timer*) of the module facia buttons. Depending upon configuration, the page contains the voltage reading of the generator and mains that is measured from the module's voltage inputs or engine tier 4 information read from the CAN.

4.3.3.1 VOLTAGE INSTRUMENTATION

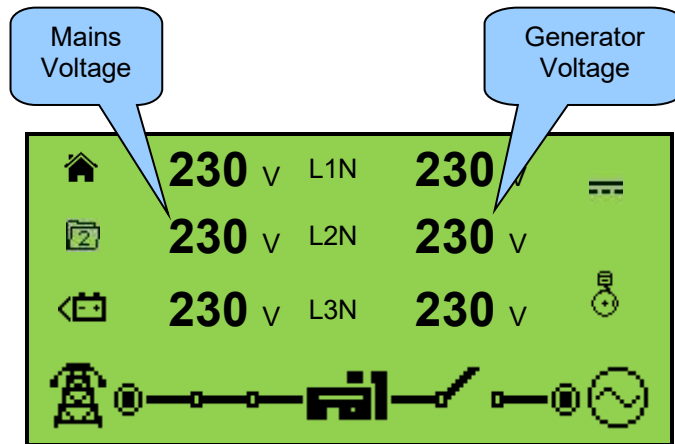

- Generator Voltage (ph-N / ph-ph)
- Mains Voltage (ph-N / ph-ph) (DSE4520 MKII only)

4.3.3.2 ENGINE TIER 4 INSTRUMENTATION

NOTE: For more information on the engine tier 4 icons, refer to the section entitled *Engine Tier 4 Information* elsewhere in this manual.

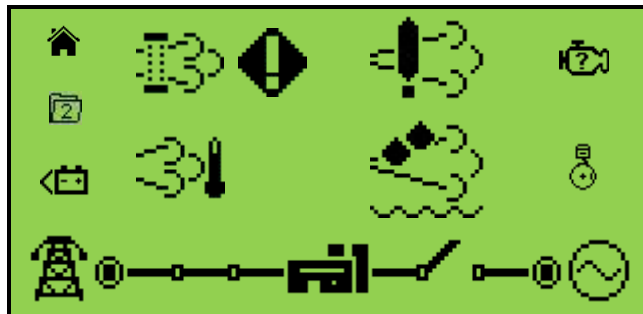

4.3.4 GENERATOR

These pages contain electrical values of the generator, measured, or derived from the module's voltage inputs.

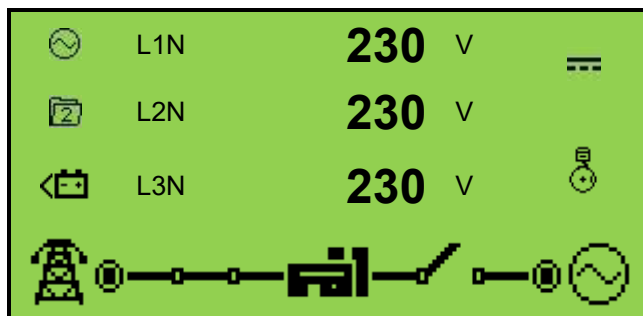

- Generator Voltage (ph-N)
- Generator Voltage (ph-ph)
- Generator Frequency

4.3.5 MAINS (DSE4520 MKII ONLY)

These pages contain electrical values of the mains, measured, or derived from the module's voltage inputs.

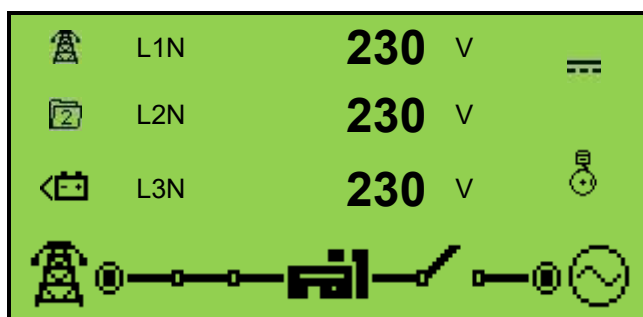

- Mains Voltage (ph-N)
- Mains Voltage (ph-ph)
- Mains Frequency

4.3.6 LOAD

These pages contain electrical values of the load, measured, or derived from the module's voltage and current inputs. The power values displayed depend on which supply is on load.

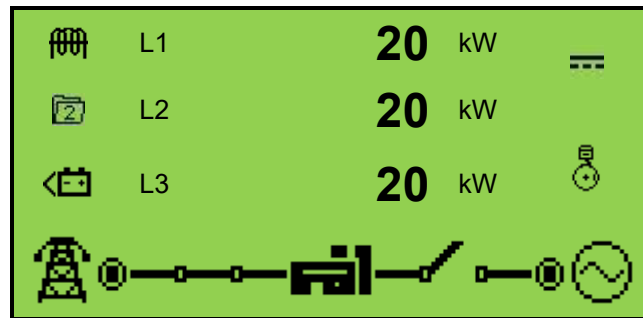

- Generator Current (A)
- Mains Current (A) (DSE4520 MKII only)
- Load ph-N (kW)
- Total Load (kW)
- Load ph-N (kVA)
- Total Load (kVA)
- Load ph-N (kvar)
- Total Load (kvar)
- Power Factor ph-N
- Power Factor Average
- Accumulated Load (kWh, kVAh, kvarh)

4.3.7 ENGINE

NOTE*: For further details of supported engine instrumentation from CAN, refer to DSE Publication: *057-004 Electronic Engines and DSE Wiring Guide*.

These pages contain instrumentation gathered about the engine measured or derived from the module's inputs, some of which may be obtained from the engine ECU.

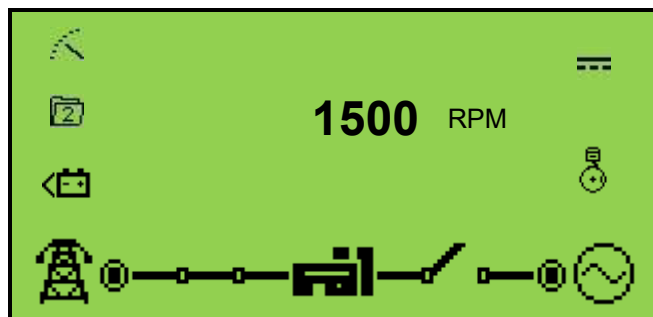

- Engine Speed
- Engine Run Time
- Engine Battery Voltage
- Engine Charge Alternator Voltage
- Engine Coolant Temperature
- Engine Oil Pressure
- Engine Fuel Level or Flexible Sensor
- Engine Oil Temperature*
- Inlet Manifold Temperature*
- Exhaust Temperature 1*
- Exhaust Temperature 2*
- Coolant Pressure 1*
- Coolant Pressure 2*
- Turbo Pressure 1*
- Turbo Pressure 2*
- Fuel Consumption*
- Fuel Pressure*
- Total Fuel Used*
- Soot Level*
- Ash Level*
- DEF Level*
- DEF Temperature*
- DEF Consumption*
- DEF Inducement Reason*
- DEF Inducement Severity*
- EGR Pressure*
- EGR Temperature*
- Ambient Air Temp*
- Air Intake Temp*
- Engine Maintenance Due – Oil
- Engine Maintenance Due – Air
- Engine Maintenance Due – Fuel

4.3.8 CONFIGURABLE CAN INSTRUMENTS

NOTE: Depending upon the module's configuration, some display screens may be disabled. For further details of module configuration, refer to DSE Publication: *057-258 DSE4510 MKII & DSE4520 MKII Configuration Suite PC Software Manual*.

The configurable CAN instruments are intended to display CAN information from external third party CAN devices such as fuel flow meters. The contents of these screens vary depending upon configuration by the engine manufacturer or supplier.

Under default factory settings the configurable CAN instruments are not viewable. They are configurable by the system designer using the DSE Configuration Suite software.

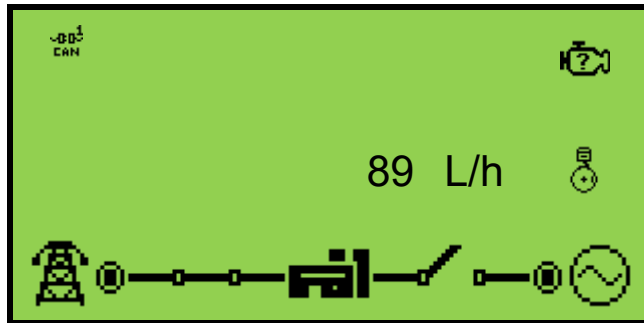

- Configurable CAN Instrumentation 1 to 10

4.3.9 INFO

These pages contain information about the controller.

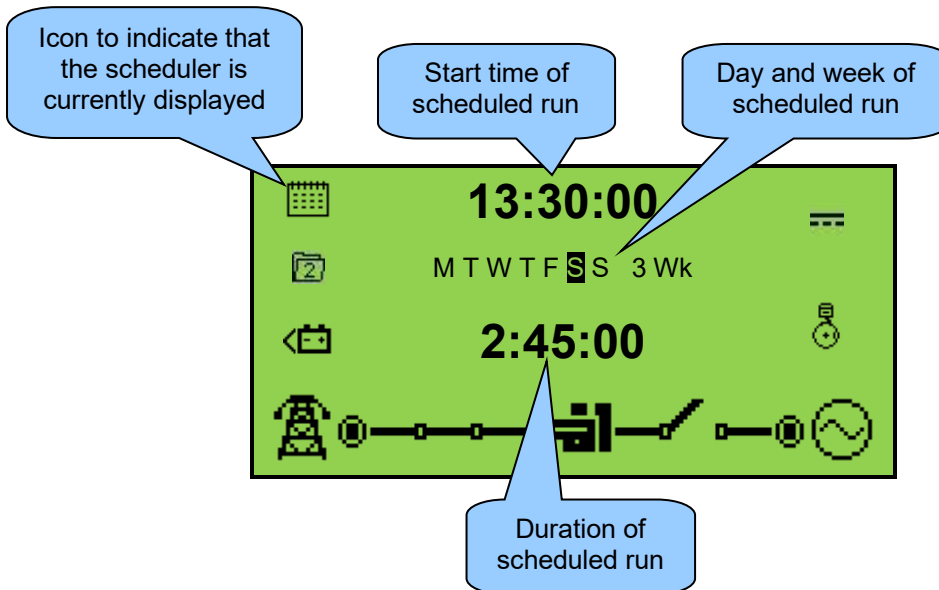





- Module's date and time
- Scheduler settings
- Product description and USB identification number
- Application and Engine Version

4.3.10 ENGINE DTC (ECU ALARMS)



If the DSE module is connected to an ECU, this page contains active *Diagnostic Trouble Codes (DTC)* only if the engine ECU generating a fault code. These are alarm conditions are detected by the engine ECU and displayed by the DSE controller.

4.3.10.1 VIEWING ACTIVE ENGINE DTC

To view the engine DTC(s), press both  (up) and  (down) buttons simultaneously, the navigation menu is then displayed. Once entered, cycle to the DTC  section and enter.

To view the active DTC(s) alarms, repeatedly press the  (up) or  (down) buttons until the LCD screen displays the alarm.

Continuing to press the  (up) or  (down) buttons will cycle through the alarms.



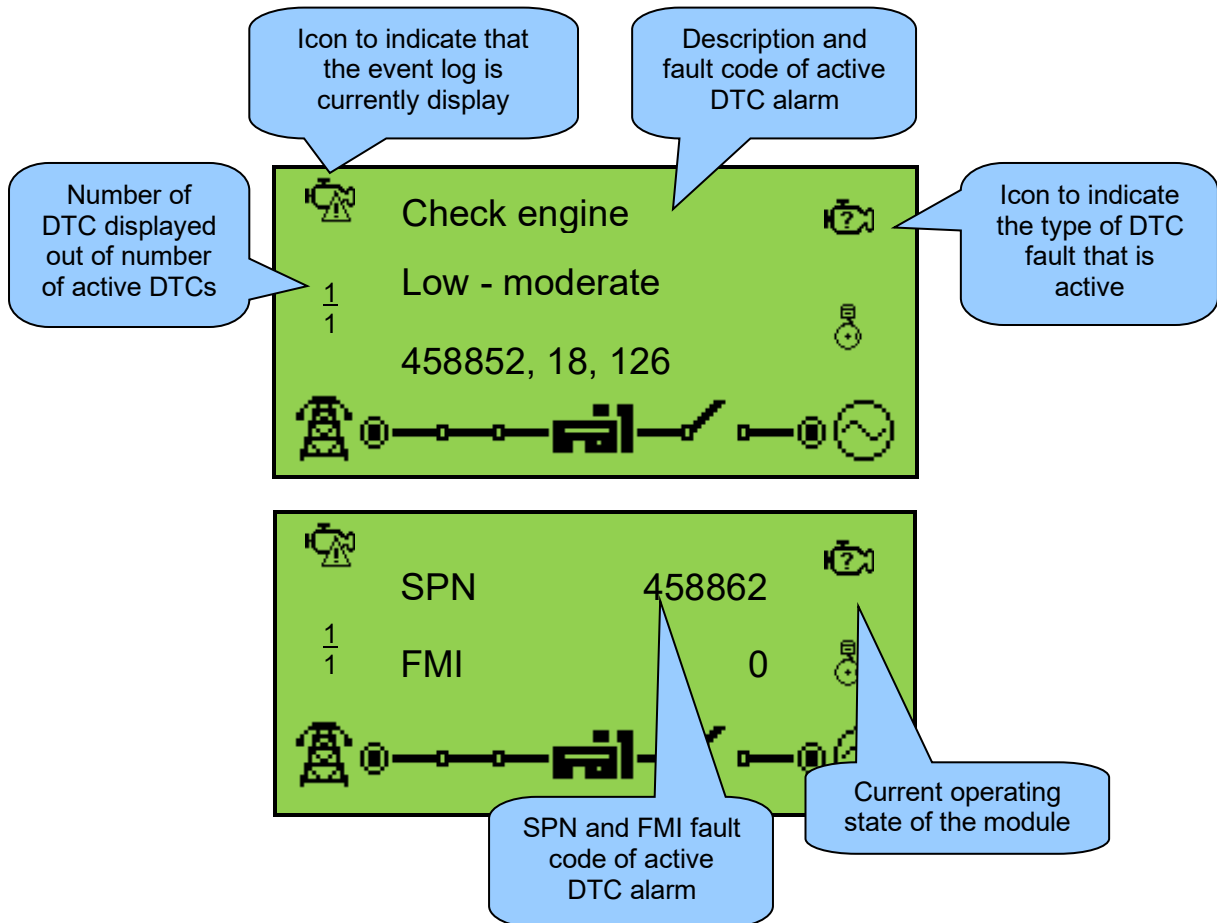



To exit the active DTC(s) alarm section, press the  (up) and  (down) buttons simultaneously to enter the navigation menu. Once entered, cycle to the desired instrumentation section.



A list of CAN fault icons is overleaf...

 **NOTE:** For details on these code meanings, refer to the ECU instructions provided by the engine manufacturer, or contact the engine manufacturer for further assistance.

 **NOTE:** For further details on connection to electronic engines, refer to DSE Publication: *057-004 Electronic Engines And DSE Wiring*



Icon	Fault	DTC Description
	Check Engine Fault	The engine ECU has detected a fault not recognised by the DSE module, contact engine manufacturer for support.
	Low Oil Pressure	The engine ECU has detected that the engine oil pressure has fallen below its configured low oil pressure alarm level.
	Under Speed	The engine ECU has detected that the engine speed has fallen below its configured under speed alarm level.
	Over Speed	The engine ECU has detected that the engine speed has risen above its configured over speed alarm level.
	Charge Failure	The engine ECU has detected that the engine's charge alternator output has fallen below its configured alarm level.
	Low Fuel Level	The engine ECU has detected that the engine's fuel level has fallen below its configured low fuel level alarm.
	Battery Under/Over Voltage	The engine ECU has detected that the engine's DC supply has fallen below or risen above its configured alarm level.

4.3.11 EVENT LOG



This module's event log contains a list of the last 50 record electrical trips, shutdowns, mains fails, mains returns and power up events and the engine hours at which they occurred.



Once the log is full, any subsequent electrical trip or shutdown alarms overwrites the oldest entry in the log. Hence, the log always contains the most recent shutdown alarms. The module logs the alarm, along with the engine running hours.

4.3.11.1 VIEWING THE EVENT LOG

To view the event log, press both  (up) and  (down) buttons simultaneously, the navigation menu is then displayed. Once entered, cycle to the *Event Log* () section and enter.



To view the event log, repeatedly press the  (up) or  (down) buttons until the LCD screen displays the desired event.

Continuing to press down the  (up) or  (down) buttons will cycle through the past alarms after which the display shows the most recent alarm and the cycle begins again.

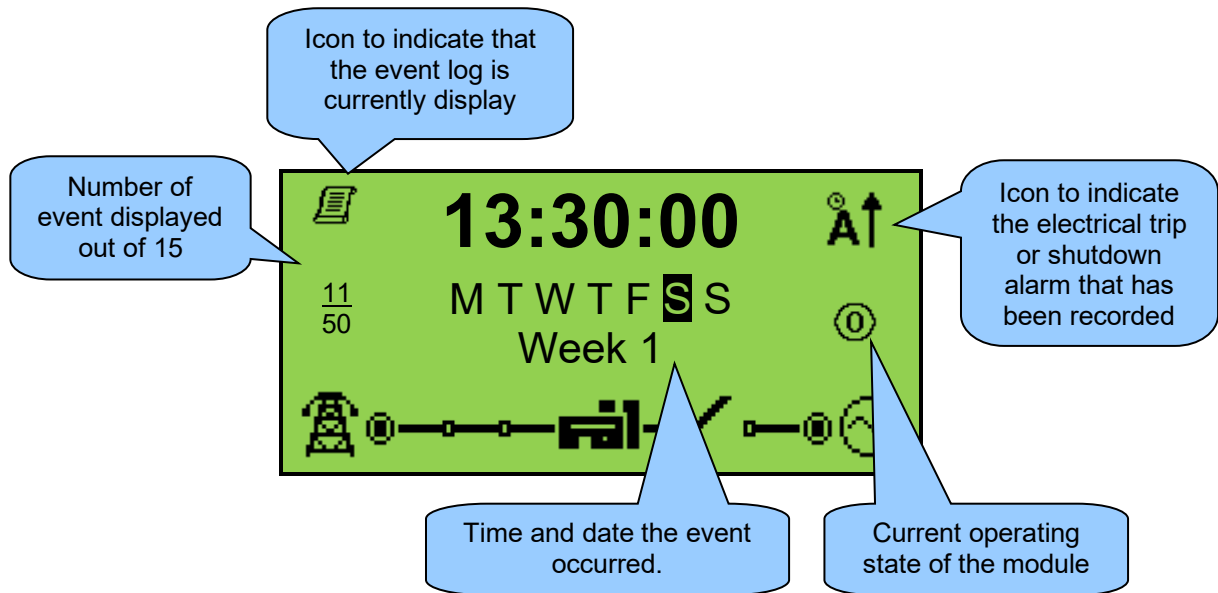
To exit the event log, press the  (up) and  (down) buttons simultaneously to enter the navigation menu. Once entered, cycle to the desired instrumentation section.



The events shown in the below table are recorded into the module's event log in addition to all electrical trip and shutdown alarms.

Icon	Event	Description
	Mains Failure	The mains supply was detected as failed as it had risen above or fallen below the pre-set alarm setting.
	Mains Return	The mains supply was detected as healthy as it was no longer in a fault condition
	Module Power Up	The module was powered up



4.3.12 ENGINE TIER 4 INFORMATION



 **NOTE:** For further details of module configuration, refer to DSE Publication: *057-258 DSE4510 MKII & DSE4520 MKII Configuration Software Manual*.



 **NOTE:** For details on these icon meanings, refer to the ECU instructions provided by the engine manufacturer, or contact the engine manufacturer for further assistance.



 **NOTE:** For further details on connection to electronic engines, refer to DSE Publication: *057-004 Electronic Engines And DSE Wiring*



If the DSE module is connected to an ECU, This page contains active *Engine Tier 4 Lamps* only if the engine ECU is generating a fault code. These are alarm conditions are detected by the engine ECU and displayed by the DSE controller.

To view the *Engine Tier 4 Lamps* or *DPF Inhibit Control* page, press the  (up) or  (down) buttons until the LCD screen displays the desired event.

Continuing to press down the  (up) or  (down) buttons will cycle through the past alarms after which the display shows the most recent alarm and the cycle begins again.

To view the *Engine Tier 4 Lamps* or *DPF Inhibit Control* page, press both  (up) and  (down) buttons simultaneously, the navigation menu is then displayed. Once entered, cycle to the *Engine Tier 4* () section and enter.

To view the *Engine Tier 4 Lamps* or *DPF Inhibit Control* pages, press the  (up) or  (down) buttons until the LCD screen displays the desired page.

To exit the *Engine Tier 4* section, press the  (up) and  (down) buttons simultaneously to enter the navigation menu. Once entered, cycle to the desired instrumentation section.

4.3.12.1 ENGINE TIER 4 LAMPS

NOTE: Depending upon the module's configuration, the home screen may be set to display engine tier 4 information. For further details of module configuration, refer to DSE Publication: 057-258 *DSE4510 MKII & DSE4520 MKII Configuration Suite PC Software Manual*.

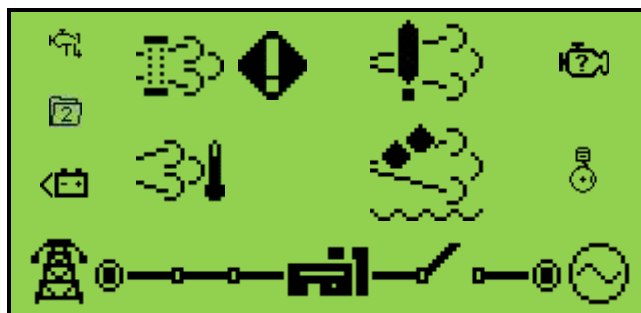



Icon	Fault	Description
	ECU Amber Alarm	The module received an Amber fault condition from the engine ECU.
	ECU Red Alarm	The module received a Red fault condition from the engine ECU.
	DPF Stop	The module received a fault indication from the engine ECU informing that the <i>Diesel Particulate Filter</i> has been stopped.
	DPF Warning	The module received a fault condition from the engine ECU informing that the <i>Diesel Particulate Filter</i> has a fault condition.
	HEST Active	The module received a fault indication from the engine ECU informing that the <i>High Exhaust System Temperature</i> is active.
	DEF Low Level	The module received a fault condition from the engine ECU informing that the <i>Diesel Exhaust Fluid Low Level</i> is active.
	SCR Inducement	The module received a fault indication from the engine ECU informing that the <i>Selective Catalytic Reduction Inducement</i> is active.

4.3.12.2 DPF INHIBIT CONTROL

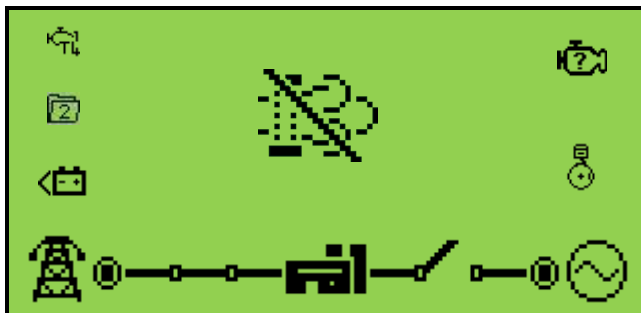
To inhibit or enable the DPF Control, press the **Auto Mode**  (✓) button.



Icon	Fault	Description
	DPF Active	The module received a fault indication from the engine ECU informing that the <i>Diesel Particulate Filter</i> is active.
	DPF Inhibited	The module received a fault indication from the engine ECU informing that the <i>Diesel Particulate Filter</i> has been inhibited.

5 OPERATION

NOTE: The following descriptions detail the sequences followed by a module containing the standard 'factory configuration'. Always refer to your configuration source for the exact sequences and timers observed by any module in the field.

5.1 QUICKSTART GUIDE

This section provides a quick start guide to the module's operation.

5.1.1 STARTING THE ENGINE

NOTE: For further details, see the section entitled *Operation* elsewhere in this document.



5.1.2 STOPPING THE ENGINE

NOTE: For further details, see the section entitled *Operation* elsewhere in this document.



5.2 STOP/RESET MODE

NOTE: If a digital input configured to *Panel Lock* is active, changing module modes is not possible. Viewing the instruments and event logs is NOT affected by *Panel Lock*.

NOTE: For further details of module configuration, refer to DSE Publication: *057-258 DSE4510 MKII & DSE4520 MKII Configuration Suite PC Software Manual*.

Stop/Reset Mode is activated by pressing the **Stop/Reset Mode** button.

The **Stop/Reset** icon is displayed to indicate **Stop/Reset Mode** operations.

In **Stop/Reset Mode**, the module removes the generator from load (if necessary) before stopping the generator.

If the generator does not stop when requested, the **Fail To Stop** alarm is activated (subject to the setting of the *Fail to Stop* timer). To detect the engine at rest the following must occur:

- Engine speed is zero as detected by the CAN ECU
- Generator AC Voltage and Frequency must be zero.
- Engine Charge Alternator Voltage must be zero.
- Oil pressure sensor must indicate low oil pressure

When the engine has stopped and the module is in the **Stop/Reset Mode**, it is possible to send configuration files to the module from DSE Configuration Suite PC software and to enter the Front Panel Editor to change parameters.

Any latched alarms that have been cleared are reset when **Stop/Reset Mode** is entered.

The engine is not started when in **Stop/Reset Mode**. If start signals are given, the input is ignored until **Auto Mode** is entered.

When the unit is configured for 'Power Save Mode' and has been left in **Stop/Reset Mode** with no presses of the fascia buttons, the module enters Power Save Mode. To 'wake' the module, press any fascia control buttons or activate Digital Input A. The same is true for Deep Sleep Mode.

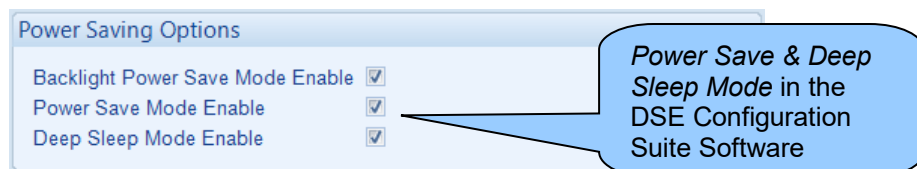

5.3 AUTOMATIC MODE

 **NOTE:** If a digital input configured to external *Panel Lock* is active, changing module modes is not possible. Viewing the instruments and event logs is **NOT** affected by *Panel Lock*.

Auto Mode is activated by pressing the **Auto Mode**  button.

The **Auto Mode**  icon is displayed to indicate **Auto Mode** operations if no alarms are present.

Auto Mode  allows the generator to operate fully automatically, starting and stopping as required with no user intervention.

5.3.1 WAITING IN AUTO MODE

If a starting request is made, the starting sequence begins. Starting requests can be from the following sources:

- Failure of mains supply (DSE4520 MKII only)
- Activation of the inbuilt exercise scheduler.
- Activation of an auxiliary input that has been configured to *Remote Start On Load* or *Remote Start Off Load*.
- Activation of an auxiliary input that has been configured to *Auxiliary Mains Fail* (DSE4520 MKII Only).

5.3.2 STARTING SEQUENCE

 **NOTE:** If the unit has been configured for CAN, compatible ECU's receive the start command via CAN and transmit the engine speed to the DSE controller.

 **NOTE:** For further details of module configuration, refer to DSE Publication: *057-258 DSE4510 MKII & DSE4520 MKII Configuration Suite PC Software Manual*.

To allow for 'false' start requests, the *Start Delay* timer begins.

Should all start requests be removed during the *Start Delay* timer, the unit returns to a stand-by state.

If a start request is still present at the end of the *Start Delay* timer, the fuel relay is energised, and the engine is cranked.

If the engine fails to fire during this cranking attempt then the starter motor is disengaged for the *Crank Rest* duration after which the next start attempt is made. Should this sequence continue beyond the *Set Number Of Attempts*, the start sequence is terminated, and the display shows **Fail to Start !-L**.

The starter motor is disengaged when the engine fires. Speed detection is factory configured to be derived from the AC alternator output frequency but can additionally be measured from a Magnetic Pickup mounted on the flywheel or from the CAN link to the engine ECU depending on module.

Additionally, rising oil pressure can be used to disconnect the starter motor (but cannot detect underspeed or overspeed).

After the starter motor has disengaged, the *Safety On Delay* timer activates, allowing Oil Pressure, High Engine Temperature, Under-speed, Charge Fail and any delayed Auxiliary fault inputs to stabilise without triggering the fault.

5.3.3 ENGINE RUNNING

 **NOTE: The load transfer signal remains inactive until the generator is available. This prevents excessive wear on the engine and alternator.**

The generator is placed on load if configured to do so.

If all start requests are removed, the *Stopping Sequence* begins.

5.3.4 STOPPING SEQUENCE

The *Return Delay* timer operates to ensure that the starting request has been permanently removed and is not just a short term removal. Should another start request be made during the cooling down period, the set returns on load.

If there are no starting requests at the end of the *Return Delay* timer, the load is transferred from the generator to the mains supply and the *Cooling Down* timer is initiated.

The *Cooling Down* timer allows the set to run off load and cool sufficiently before being stopped. This is particularly important where turbo chargers are fitted to the engine.



After the *Cooling Down* timer has expired, the set is stopped.

5.4 MANUAL/START MODE

NOTE: If a digital input configured to Panel Lock is active, changing module modes is not possible. Viewing the instruments and event logs is NOT affected by panel lock.

To begin the starting sequence, press the **Manual/Start Mode**  button. If 'protected start' is disabled, the start sequence begins immediately.

NOTE: For further details of module configuration, refer to DSE Publication: *057-258 DSE4510 MKII & DSE4520 MKII Configuration Suite PC Software Manual*.

If Protected Start is enabled, the **Waiting in Manual Mode**  icon is displayed and the LED above the **Manual/Start Mode**  button flashes to indicate **Waiting in Manual Mode**.

The **Manual/Start Mode**  button must be pressed once more to begin the start sequence.

Protected Start Mode



Protected Start Mode setting in the DSE Configuration Suite Software

5.4.1 STARTING SEQUENCE

NOTE: There is no *Start Delay* in this mode of operation.

NOTE: If the unit has been configured for CAN, compatible ECU's receives the start command via CAN.

NOTE: For further details of module configuration, refer to DSE Publication: *057-258 DSE4510 MKII & DSE4520 MKII Configuration Suite PC Software Manual*.

The fuel relay is energised, and the engine is cranked.

If the engine fails to fire during this cranking attempt then the starter motor is disengaged for the *Crank Rest Timer* duration after which the next start attempt is made. Should this sequence continue beyond the set *Number Of Attempts*, the start sequence is terminated, and the display shows **Fail to Start** .

The starter motor is disengaged when the engine fires. Speed detection is factory configured to be derived from the AC alternator output frequency but can additionally be measured from a Magnetic Pickup mounted on the flywheel or from the CANbus link to the engine ECU depending on module configuration.

Additionally, rising oil pressure can be used to disconnect the starter motor (but cannot detect underspeed or overspeed).

After the starter motor has disengaged, the *Safety On Delay* timer activates, allowing Oil Pressure, High Engine Temperature, Under-speed, Charge Fail and any delayed Auxiliary fault inputs to stabilise without triggering the fault.

5.4.2 ENGINE RUNNING



 **NOTE: The load transfer signal remains inactive until the generator is available. This prevents excessive wear on the engine and alternator.**

In **Manual/Start Mode** , the load is not transferred to the generator unless a 'loading request' is made.

A loading request can come from several sources.



- Failure of mains supply (DSE4520 MKII only)
- Activation of an auxiliary input that has been configured to *Remote Start On Load or Transfer to Generator, Open Mains*
- Activation of an auxiliary input that has been configured to *Auxiliary Mains Fail* (DSE4520 MKII Only).
- Activation of the inbuilt exercise scheduler if configured for 'on load' runs.

Once the generator has been placed on load, it is not automatically removed. To manually remove the load either:

- Activation of an auxiliary input that has been configured to *Transfer to Mains, Open Generator*
- Press the **Auto Mode**  button to return to automatic mode. The set observes all **Auto Mode**  start requests and stopping timers before beginning the *Auto Mode Stopping Sequence*.
- Press the **Stop/Reset Mode**  button to remove load and stop the generator.
- Activation of an auxiliary input that has been configured to *Generator Load Inhibit*.

5.4.3 STOPPING SEQUENCE

In **Manual/Start Mode**  the set continues to run until either:

- The **Stop/Reset Mode**  button is pressed – The delayed load outputs are de-activated immediately and the set immediately stops.
- The **Auto Mode**  button is pressed. The set observes all **Auto Mode**  start requests and stopping timers before beginning the *Auto Mode Stopping Sequence*.

5.5 MAINTENANCE ALARMS

Depending upon module configuration one or more levels of engine maintenance alarm may occur based upon a configurable schedule.

Example 1

Screen capture from DSE Configuration Suite Software showing the configuration of the Maintenance Alarm for Oil, Air and Fuel.

When activated, the maintenance alarm can be either a **warning** (set continues to run) or **shutdown** (running the set is not possible).

Resetting the maintenance alarm is normally actioned by the site service engineer after performing the required maintenance.

The method of reset is either by:

- Activating an input that has been configured to Maintenance Reset Alarm x, where x is the type of maintenance alarm (Air, Fuel or Oil).
- Pressing the maintenance reset button in the DSE Configuration Suite, Maintenance section.
- Pressing and holding the **Stop/Reset Mode**  button for 10 seconds on the desired Maintenance Alarm status page. This can be protected by a PIN number.

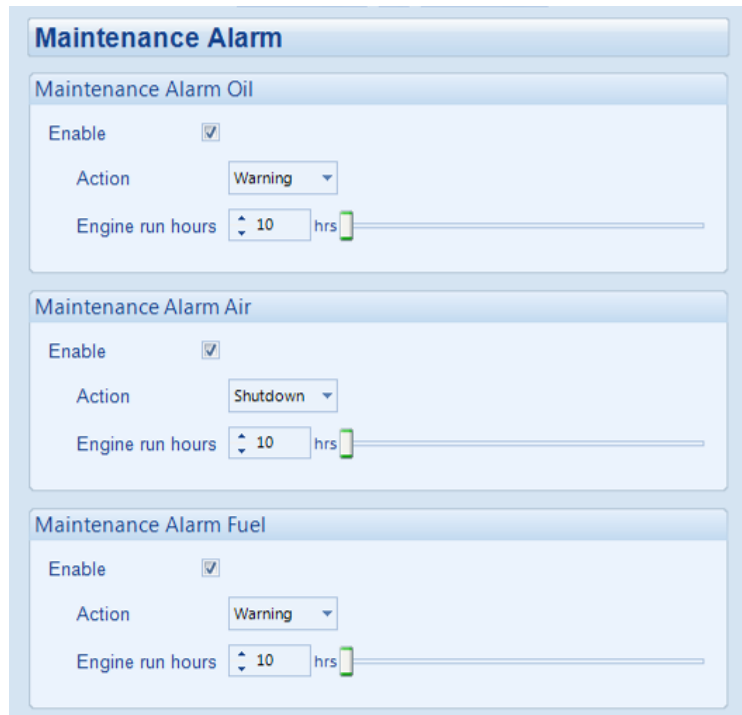

Example 2

Screen capture from DSE Configuration Suite Software showing the configuration of a digital input for Maintenance Reset Alarm Air.

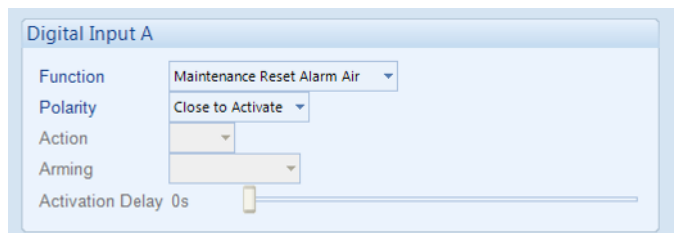

Example 3

Screen capture from DSE Configuration Suite Software showing the Maintenance Alarm Reset 'button' in the DSE Configuration Suite SCADA | MAINTENANCE section.

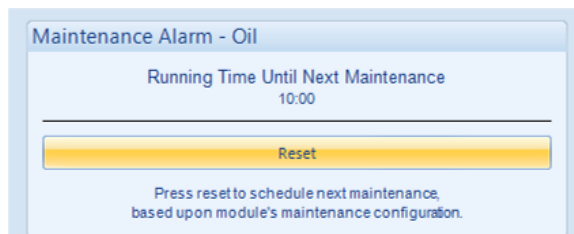

5.6 SCHEDULER

The controller contains an inbuilt exercise run scheduler, capable of automatically starting and stopping the set. Up to 8 scheduled start/stop sequences can be configured to repeat on a 7-day or 28-day cycle.

Scheduled runs may be on load or off load depending upon module configuration.

Example

Screen capture from DSE Configuration Suite Software showing the configuration of the Exercise Scheduler.



In this example the set will start at 09:00 on Monday and run for 5 hours, then start at 13:30 on Tuesday and run for 30 minutes.

Week	Day	Start Time	Duration	
	Monday	09:00	05:00	Clear
	Tuesday	13:30	00:30	Clear
	Monday	00:00	00:00	Clear
	Monday	00:00	00:00	Clear
	Monday	00:00	00:00	Clear
	Monday	00:00	00:00	Clear
	Monday	00:00	00:00	Clear
	Monday	00:00	00:00	Clear
	Monday	00:00	00:00	Clear





5.6.1 STOP MODE

- Scheduled runs do not occur when the module is in **Stop/Reset Mode** .

5.6.2 MANUAL MODE

- Scheduled runs do not occur when the module is in **Manual/Start Mode**  waiting for a start request.
- Activation of a Scheduled Run 'On Load' when the module is operating Off Load in **Manual/Start Mode**  the set to run On Load.

5.6.3 AUTO MODE

- Scheduled runs operate only if the module is in **Auto Mode**  with no *Shutdown* or *Electrical Trip* alarm active.
- If the module is in **Stop/Reset Mode**  or **Manual/Start Mode**  when a scheduled run begins, the engine is not started. However, if the module is moved into **Auto Mode**  during a scheduled run, the engine is called to start.
- Depending upon configuration by the system designer, an external input can be used to inhibit a scheduled run.
- If the engine is running *Off Load* in **Auto Mode**  and a scheduled run configured to 'On Load' begins, the set is placed *On Load* for the duration of the Schedule.

5.8 ALTERNATIVE CONFIGURATIONS

Depending upon the configuration of the system by the generator supplier, the system may have selectable configurations (for example to select between 50 Hz and 60 Hz). If this has been enabled the generator supplier will advise how this selection can be made (usually by operating an external selector switch or by selecting the required configuration file in the module's front panel configuration editor).

6 FRONT PANEL CONFIGURATION

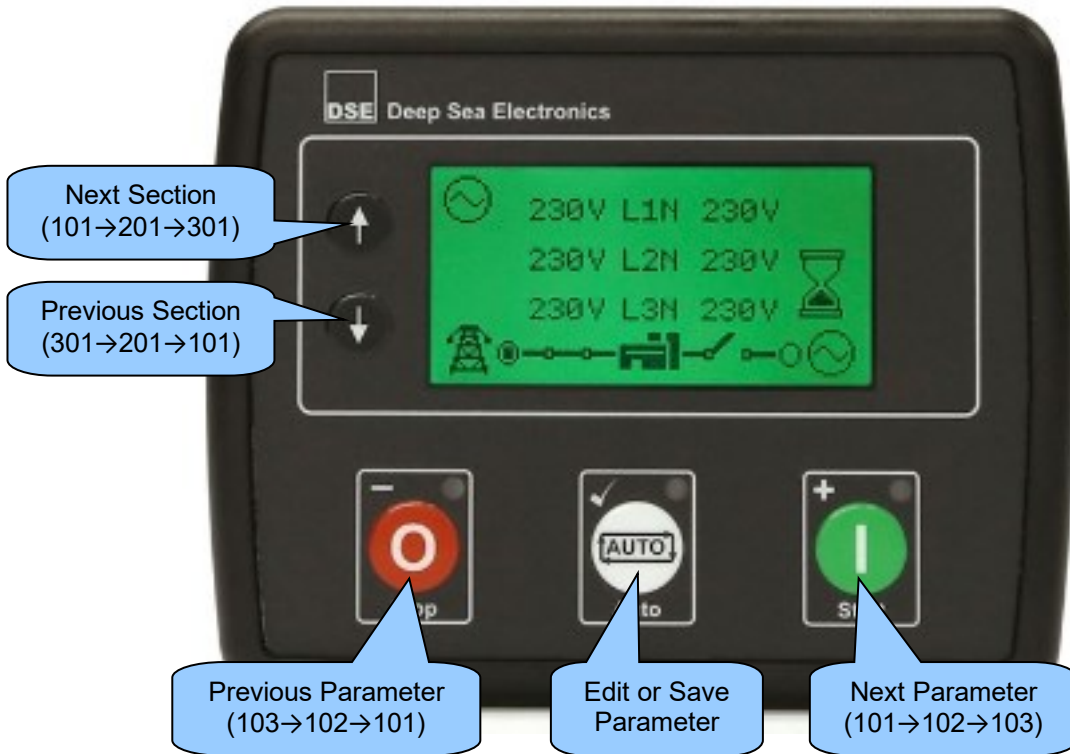

This configuration mode allows the operator to configure most of the module through its display without the use of the DSE Configuration Suite PC Software.

Use the module's facia buttons to traverse the menu and make value changes to the parameters:





6.1 ACCESSING THE MAIN CONFIGURATION EDITOR







 **NOTE:** More comprehensive module configuration is possible via PC configuration software. For further details of module configuration, refer to DSE Publication: 057- 258 *DSE4510 MKII & DSE4520 MKII Configuration Suite PC Software Manual*.

- Ensure the engine is at rest and the module by pressing the **Stop/Reset Mode**  button.
- Press the **Stop/Reset Mode**  (-) and **Auto Mode**  (✓) buttons together to enter the main configuration editor.



6.2 ENTERING PIN









 **NOTE:** The PIN is not set by DSE when the module leaves the factory. If the module has a PIN code set, the generator supplier has entered this. Contact the generator supplier if the code is required. If the code has been 'lost' or 'forgotten', the module must be returned to the DSE factory to have the PIN removed. A charge is made for this procedure. This procedure cannot be performed away from the DSE factory.

 **NOTE:** The PIN is automatically reset when the editor is exited (manually or automatically) to ensure security.

- If a module security PIN has been set, the PIN request is then shown.
- Press the **Auto Mode**  (✓), the first '#' changes to '0'. Press the **Up**  or **Down**  buttons to adjust it to the correct value.
- Press the **Manual/Start Mode**  (+) buttons to move to the next digit. The digit previously entered now shows as '#' for security.
- Repeat this process for the other digits of the PIN number. Press the **Stop/Reset Mode**  (-) button to move back to adjust one of the previous digits.
- When the **Auto Mode**  (✓) button is pressed after editing the final PIN digit, the PIN is checked for validity. If the number is not correct, the PIN must be re-entered.
- If the PIN has been successfully entered (or the module PIN has not been enabled), the editor is displayed.



6.3 EDITING A PARAMETER

 **NOTE:** Pressing and holding the **Stop/Reset Mode**  (-) or **Manual/Start Mode**  (+) buttons enables an auto-repeat functionality.

- Once in the selected editor, press the **Up**  and **Down**  navigation buttons to cycle through it in increments of 100.
- Press the **Stop/Reset Mode**  (-) or **Manual/Start Mode**  (+) buttons to cycle through the editor in increments of 1.
- When viewing the parameter to be edited, press the **Auto Mode**  (✓) button, the value begins to flash.
- Press the **Stop/Reset Mode**  (-) or **Manual/Start Mode**  (+) buttons to adjust the value to the required setting.
- Press the **Auto Mode**  (✓) button to save the current value, the value ceases flashing.

6.4 EXITING THE MAIN CONFIGURATION EDITOR

 **NOTE:** The editor automatically exits after 5 minutes of inactivity to ensure security.

- Press and hold the **Stop/Reset Mode**  (-) button to exit the editor without saving changes.
- Press and hold the **Auto Mode**  (✓) button to exit the editor and save the changes.

6.5 ADJUSTABLE PARAMETERS

NOTE: Listed parameters apply to DSE45xx MKII modules of version 3.0.0 and above only. For a comprehensive list of adjustable parameters on modules below version 3.0.0, refer to DSE publication: *053-190 DSE4510 MKII & DSE4520 MKII Installation Instructions*.

	Functionality in DSE4510 MKII & DSE4520 MKII
	Functionality in DSE4520 MKII only.

6.5.1 MODULE SETTINGS

Configuration Parameters – Module (Page 1)		
101	Contrast	0 (%)
102	Fast Loading Enabled	On (1), Off (0)
103	All Warnings Latched	On (1), Off (0)
104	Lamp Test At Startup	On (1), Off (0)
105	Power Save Mode Enable	On (1), Off (0)
106	Deep Sleep Mode Enable	On (1), Off (0)
107	Protected Start Enable	On (1), Off (0)
108	Event Log Display Format	On (1), Off (0)
109	Power Up Mode	0 (Power Up Mode)
110	DTC String Enable	On (1), Off (0)
111	RESERVED	
112	Pin Protected Maintenance Reset	On (1), Off (0)
113	Stop Button Cooldown	On (1), Off (0)
114	Use Module Oil Pressure	On (1), Off (0)
115	Use Module Coolant Temp	On (1), Off (0)
116	Use Module Engine Hours	On (1), Off (0)
117	Use Module RPM	On (1), Off (0)
118	Use Module Charge Alt	On (1), Off (0)
119	Disable CAN Speed Control	On (1), Off (0)
120	CT Position	Gen (0), Load(1)
121	Generator Voltage Display	On (1), Off (0)
122	Mains Voltage Display	On (1), Off (0)
123	Generator Frequency Display	On (1), Off (0)
124	Mains Frequency Display	On (1), Off (0)
125	Current Display	On (1), Off (0)
126	kW Display	On (1), Off (0)
127	kvar Display	On (1), Off (0)
128	kVA Display	On (1), Off (0)
129	pf Display	On (1), Off (0)
130	kWh Display	On (1), Off (0)
131	kvarh Display	On (1), Off (0)
132	kVAh Display	On (1), Off (0)
133	RESERVED	
134	Show Load Switching Icons	On (1), Off (0)
135	Backlight Inactivity Timer	On (1), Off (0)
136	ECU Periodic Wake Up	On (1), Off (0)
137	Coolant Temp Persistence	On (1), Off (0)
138	Limit Audible Alarm Duration	On (1), Off (0)
139	Transducer Power Supply Enabled	On (1), Off (0)
140	English Text Mode	On (1), Off (0)

6.5.2 CAN SETTINGS

	Functionality in DSE4510 MKII & DSE4520 MKII
	Functionality in DSE4520 MKII only.

Configuration Parameters – CAN Application (Page 2)		
201	CAN Alternative Engine Speed	On (1), Off (0)
202	CAN ECU Data Fail Arming	0 (Arming)
203	CAN ECU Data Fail Action	0 (Action)
204	CAN ECU Data Fail Delay	0 s

6.5.3 DIGITAL INPUT SETTINGS

Configuration Parameters – Digital Inputs (Page 3)		
301	Digital Input A Source	0 (Input Source)
302	Digital Input A Polarity	0 (Polarity)
303	Digital Input A Action (If Source = User Config)	0 (Action)
304	Digital Input A Arming (If Source = User Config)	0 (Arming)
305	Digital Input A Activation Delay (If Source = User Config)	0 s
306	Digital Input B Source	0 (Input Source)
307	Digital Input B Polarity	0 (Polarity)
308	Digital Input B Action (If Source = User Config)	0 (Action)
309	Digital Input B Arming (If Source = User Config)	0 (Arming)
310	Digital Input B Activation Delay (If Source = User Config)	0 s
311	Digital Input C Source	0 (Input Source)
312	Digital Input C Polarity	0 (Polarity)
313	Digital Input C Action (If Source = User Config)	0 (Action)
314	Digital Input C Arming (If Source = User Config)	0 (Arming)
315	Digital Input C Activation Delay (If Source = User Config)	0 s
316	Digital Input D Source	0 (Input Source)
317	Digital Input D Polarity	0 (Polarity)
318	Digital Input D Action (If Source = User Config)	0 (Action)
319	Digital Input D Arming (If Source = User Config)	0 (Arming)
320	Digital Input D Activation Delay (If Source = User Config)	0 s

6.5.4 DIGITAL OUTPUT SETTINGS

Configuration Parameters – Outputs (Page 4)		
401	Digital Output A Source	0 (Output Source)
402	Digital Output A Polarity	0 (Output Polarity)
403	Digital Output B Source	0 (Output Source)
404	Digital Output B Polarity	0 (Output Polarity)
405	Digital Output C Source	0 (Output Source)
406	Digital Output C Polarity	0 (Output Polarity)
407	Digital Output D Source	0 (Output Source)
408	Digital Output D Polarity	0 (Output Polarity)
409	Digital Output E Source	0 (Output Source)
410	Digital Output E Polarity	0 (Output Polarity)
411	Digital Output F Source	0 (Output Source)
412	Digital Output F Polarity	0 (Output Polarity)

6.5.5 TIMER SETTINGS

	Functionality in DSE4510 MKII & DSE4520 MKII
	Functionality in DSE4520 MKII only.

Configuration Parameters – Timers (Page 5)	
501	Mains Transient Delay
502	Start Delay
503	Preheat Timer
504	Crank Time
505	Crank Rest Time
506	Smoke Limiting
507	Smoke Limiting Off
508	DPF Ramp
509	Safety On Delay
510	Warm Up Time
511	Return Delay
512	Cooling Time
513	ETS Solenoid Hold
514	Failed To Stop Delay
515	Generator Transient Delay
516	Transfer Delay
517	Breaker Trip Pulse
518	Breaker Close Pulse
519	Delayed Load Output 1
520	Delayed Load Output 2
521	Delayed Load Output 3
522	Delayed Load Output 4
523	Power Save Mode Delay
524	Deep Sleep Mode Delay
525	Page Delay
526	Cooling Time at Idle
527	Backlight Power Save Delay
528	Audible Alarm Timer
529	Fuel Pull in Coil Duration
530	ECU Override Time
531	ECU Periodic Wakeup Period
532	Post-Heat Timer
533	Delay Crank Timer
534	Max Start Pause Time

6.5.6 GENERATOR SETTINGS

Configuration Parameters – Generator (Page 6)		
601	Alternator Fitted	On (1), Off (0)
602	Alternator Poles	0
603	Under Voltage Shutdown Enable	On (1), Off (0)
604	Under Voltage Trip Shutdown	0 V
605	Under Voltage Warning Enable	On (1), Off (0)
606	Under Voltage Warning Trip	0 V
607	RESERVED	
608	Loading Voltage	0 V
609	Over Voltage Warning Enable	On (1), Off (0)
610	Over Voltage Warning Return	0 V
611	Over Voltage Warning Trip	0 V
612	Over Voltage Shutdown Trip	0 V
613	Under Frequency Shutdown Enable	On (1), Off (0)
614	Under Frequency Shutdown Trip	0.0 Hz
615	Under Frequency Warning Enable	On (1), Off (0)
616	Under Frequency Warning Trip	0.0 Hz
617	RESERVED	
618	Loading Frequency	0.0 Hz
619	Nominal Frequency	0.0 Hz
620	Over Frequency Warning Enable	On (1), Off (0)
621	Over Frequency Warning Return	0.0 Hz
622	Over Frequency Warning Trip	0.0 Hz
623	Over Frequency Shutdown Enable	On (1), Off (0)
624	Over Frequency Shutdown Trip	0.0 Hz
625	Generator AC System	0 (AC System)
626	CT Primary	0 A
627	CT Secondary	1 A, 5 A
628	Full Load Rating	0 A
629	Immediate Over Current Enable	On (1), Off (0)
630	Delayed Over Current Alarm Enable	On (1), Off (0)
631	Delayed Over Current Alarm Action	0 (Action)
632	Over Current Delay Time	0 s
633	Over Current Trip	0 %
634	kW Rating	0 kW
635	Over kW Protection Enable	On (1), Off (0)
636	Over kW Protection Action	0 (Action)
637	Over kW Protection Trip	0 %
638	Over kW Protection Trip Delay	0 s
639	Enable CT Support	On (1), Off (0)
640	Over kW Protection Return	0 %
641	Nominal Voltage	0 V

6.5.7 MAINS SETTINGS

	Functionality in DSE4510 MKII & DSE4520 MKII
	Functionality in DSE4520 MKII only.

Configuration Parameters – Mains (Page 7)		
701	AC System	0 (AC System)
702	Mains Failure Detection	On (1), Off (0)
703	Immediate Mains Dropout	On (1), Off (0)
704	Under Voltage Enable	On (1), Off (0)
705	Under Voltage Level	0 V
706	Under Voltage Return	0 V
707	Over Voltage Enable	On (1), Off (0)
708	Over Voltage Return	0 V
709	Over Voltage Level Trip	0 V
710	Under Frequency Enable	On (1), Off (0)
711	Under Frequency Trip	0.0 Hz
712	Under Frequency Return	0.0 Hz
713	Over Frequency Enable	On (1), Off (0)
714	Over Frequency Return	0 Hz
715	Over Frequency Trip	0.0 Hz

6.5.8 ENGINE SETTINGS

Configuration Parameters – Engine (Page 8)		
801	Start Attempts	0
802	Over Speed Overshoot	0 %
803	Over Speed Delay	0 s
804	Gas Choke Timer (Gas Engine Only)	0 s
805	Gas On Delay (Gas Engine Only)	0 s
806	Gas Ignition Off Delay (Gas Engine Only)	0 s
807	Crank Disconnect On Oil Pressure Enable	On (1), Off (0)
808	Check Oil Pressure Prior To Starting	On (1), Off (0)
809	Crank Disconnect On Oil	0.00 Bar
810	Crank Disconnect On Frequency	0.0 Hz
811	Crank Disconnect On Engine Speed	0 RPM
812	Under Speed Enable	On (1), Off (0)
813	Under Speed Trip	0 RPM
814	Over Speed Trip	0 RPM
815	Low Battery Voltage Enable	On (1), Off (0)
816	Low Battery Voltage Warning	0.0 V
817	Low Battery Voltage Return	0.0 V
818	Low Battery Voltage Delay	0:00:00
819	High Battery Voltage Enable	On (1), Off (0)
820	High Battery Voltage Return	0.0 V
821	High Battery Voltage Warning	0.0 V
822	High Battery Voltage Warning Delay	0 s
823	Charge Alt Shutdown Enable	On (1), Off (0)
824	Charge Alt Shutdown Trip	0.0 V
825	Charge Alt Shutdown Delay	0 s
826	Charge Alt Warning Enable	On (1), Off (0)
827	Charge Alt Warning Trip	0.0 V
828	Charge Alt Warning Delay	0 s
829	Start on Low Battery Enable	On (1), Off (0)
830	Start on Low Battery Threshold	0.0 V
831	Start on Low Battery Start Delay	0 s
832	Start on Low Battery Engine Run Duration	0 s
833 - 834	RESERVED	
835	J1939-75 Instruments Enable	On (1), Off (0)
836	J1939-75 Alarms Enable	On (1), Off (0)
837	Engine CAN Source Address	On (1), Off (0)
838	Instrumentation CAN Source Address	On (1), Off (0)
839	RESERVED	
840	Tier 4 Home Screen Enable	On (1), Off (0)
841	Start Pause Time	0 s
842	Preheat Enable	On (1), Off (0)
843	Preheat Temperature	0 °C
844	Post-heat Enabled	On (1), Off (0)
845	Post-heat Temperature	0 °C
846	Coolant Heater Enabled	On (1), Off (0)
847	Coolant Heater On Temp	0 °C
848	Coolant Heater Off Temp	0 °C
849	Coolant Cooler Enabled	On (1), Off (0)
850	Coolant Cooler On Temp	0 °C
851	Coolant Cooler Off Temp	0 °C
852	RESERVED	
853	Tank Bund Level High Alarm	0 (Action)

Continued overleaf...

Configuration Parameters – Engine (Page 8)		
854	Fan Speed Low Arming	0 (Arming)
855	Fan Speed Low Action	0 (Action)
856	Fan Speed Low Delay	0 s
857	Fuel Low Switch Arming	0 (Arming)
858	Fuel Low Switch Action	0 (Action)
859	Fuel Low Switch Delay	0 s
860	Crank Disconnect on Charge Alt Enable	On (1), Off (0)
861	Crank Disconnect on Charge Alt Voltage	0.0 V

6.5.9 ANALOGUE INPUT SETTINGS

Configuration Parameters – Analogue Inputs (Page 9)		
901-902	RESERVED	
903	Low Oil Pressure Enable	On (1), Off (0)
904	Low Oil Pressure Trip	0 Bar
905	Oil Pressure Sensor Open Circuit	On (1), Off (0)
906-907	RESERVED	
908	High Engine Temperature Trip	0.00 °C
909	Temperature Sensor Open Circuit	On (1), Off (0)
910-929	RESERVED	
930	Fuel Sensor C Low Alarm Action	Shutdown (2), Electrical Trip (1), Disabled (0)
931	Fuel Sensor C Low Shutdown Trip	0 %
932	Fuel Sensor C Low Shutdown Delay	0 s
933	Fuel Sensor C Low Pre-Alarm Enable	On (1), Off (0)
934	Fuel Sensor C Low Pre-Alarm Trip	0 %
935	Fuel Sensor C Low Pre-Alarm Return	0 %
936	Fuel Sensor C Low Pre-Alarm Delay	0 s
937	Fuel Sensor C High Pre-Alarm Enable	On (1), Off (0)
938	Fuel Sensor C High Pre-Alarm Return	0 %
939	Fuel Sensor C High Pre-Alarm Trip	0 %
940	Fuel Sensor C High Pre-Alarm Delay	0 s
941	RESERVED	
942	Fuel Sensor C High Alarm Action	Shutdown (2), Electrical Trip (1), Disabled (0)
943	Fuel Sensor C High Alarm Trip	0 %
944	Fuel Sensor C High Alarm Delay	0 s
945-967	RESERVED	
968	Fuel Usage Alarm (Run) Arming	On (1), Off (0)
969	Fuel Usage Alarm (Run) Action	0 (Action)
970	Fuel Usage Alarm (Run) Trip	0 %
971	Fuel Usage Alarm (Run) Return	0 %
972	Fuel Usage Alarm (Stopped) Arming	0 (Arming)
973	Fuel Usage Alarm (Stopped) Action	0 (Action)
974	Fuel Usage Alarm (Stopped) Trip	0 %
975	Fuel Usage Alarm (Stopped) Return	0 %
976	Low Coolant Level Arming	0 (Arming)
977	Low Coolant Level Action	0 (Action)
978	Low Coolant Level Trip	0 %
979	Low Coolant Level Return	0 %
980	Low Coolant Level Delay	00:00:00
981	Low Coolant Level Open Circuit Arming	On (1), Off (0)
982	Low Coolant Level Switch Arming	0 (Arming)
983	Low Coolant Level Switch Action	0 (Action)
984	Low Coolant Level Switch Delay	00:00:00
985	High Engine Temp Pre-Alarm Enable	On (1), Off (0)
986	High Engine Temp Pre-Alarm Return	0.00 °C
987	High Engine Temp Pre-Alarm Trip	0.00 °C

6.5.10 SCHEDULER SETTINGS

Configuration Parameters – Scheduler (Page 10)		
1001	Enable Scheduler	On (1), Off (0)
1002	Schedule Run On or Off Load	On (1), Off (0)
1003	Scheduler Period	Weekly(0), Monthly(1)
1004	Start Time (Entry 1)	0:00:00
1005	Day (Entry 1)	0 (1=Monday)
1006	Week (Entry 1)	1, 2, 3 or 4
1007	Duration (Entry 1)	0 s
1008	Start Time (Entry 2)	0:00:00
1009	Day (Entry 2)	0 (1=Monday)
1010	Week (Entry 2)	1, 2, 3 or 4
1011	Duration (Entry 2)	0 s
1012	Start Time (Entry 3)	0:00:00
1013	Day (Entry 3)	0 (1=Monday)
1014	Week (Entry 3)	1, 2, 3 or 4
1015	Duration (Entry 3)	0 s
1016	Start Time (Entry 4)	0:00:00
1017	Day (Entry 4)	0 (1=Monday)
1018	Week (Entry 4)	1, 2, 3 or 4
1019	Duration (Entry 4)	0 s
1020	Start Time (Entry 5)	0:00:00
1021	Day (Entry 5)	0 (1=Monday)
1022	Week (Entry 5)	1, 2, 3 or 4
1023	Duration (Entry 5)	0 s
1024	Start Time (Entry 6)	0:00:00
1025	Day (Entry 6)	0 (1=Monday)
1026	Week (Entry 6)	1, 2, 3 or 4
1027	Duration (Entry 6)	0 s
1028	Start Time (Entry 7)	0:00:00
1029	Day (Entry 7)	0 (1=Monday)
1030	Week (Entry 7)	1, 2, 3 or 4
1031	Duration (Entry 7)	0 s
1032	Start Time (Entry 8)	0:00:00
1033	Day (Entry 8)	0 (1=Monday)
1034	Week (Entry 8)	1, 2, 3 or 4
1035	Duration (Entry 8)	0 s

6.5.11 TIME SETTINGS

Configuration Parameters – Time (Page 11)		
1101	Time of Day	0:00:00
1102	RESERVED	
1103	RESERVED	
1104	Day of Month	1-31
1105	Month of Year	1-12
1106	Year	0-99

6.5.12 MAINTENANCE ALARM SETTINGS

Configuration Parameters – Maintenance Alarms (Page 12)		
1201	Oil Maintenance Alarm Enable	On (1), Off (0)
1202	Oil Maintenance Alarm Action	0 (Action)
1203	Oil Maintenance Alarm Engine Hours	0 h
1204	Air Maintenance Alarm Enable	On (1), Off (0)
1205	Air Maintenance Alarm Action	0 (Action)
1206	Air Maintenance Alarm Engine Hours	0 h
1207	Fuel Maintenance Alarm Enable	On (1), Off (0)
1208	Fuel Maintenance Alarm Action	0 (Action)
1209	Fuel Maintenance Alarm Engine Hours	0 h

6.5.13 ALTERNATIVE CONFIGURATION 1 SETTINGS

	Functionality in DSE4510 MKII & DSE4520 MKII
	Functionality in DSE4520 MKII only.

Configuration Parameters – Alternative Configuration 1 (Page 20)		
2001	Default Configuration	On (1), Off (0)
2002	Enable Configuration	On (1), Off (0)
2003	CAN Alternative Engine Speed	On (1), Off (0)
2004	Under Voltage Shutdown Enable	On (1), Off (0)
2005	Under Voltage Shutdown Trip	0 V
2006	Under Voltage Warning Enable	On (1), Off (0)
2007	Under Voltage Warning Trip	0 V
2008	Loading Voltage	0 V
2009	Over Voltage Warning Enable	On (1), Off (0)
2010	Over Voltage Warning Return	0 V
2011	Over Voltage Warning Trip	0 V
2012	Over Voltage Trip	0 V
2013	Under Frequency Shutdown Enable	On (1), Off (0)
2014	Under Frequency Shutdown Trip	0.0 Hz
2015	Under Frequency Warning Enable	On (1), Off (0)
2016	Under Frequency Warning Trip	0.0 Hz
2017	Loading Frequency	0.0 Hz
2018	Nominal Frequency	0.0 Hz
2019	Over Frequency Warning Enable	On (1), Off (0)
2020	Over Frequency Warning Return	0.0 Hz
2021	Over Frequency Warning Trip	0.0 Hz
2022	Over Frequency Shutdown Enable	On (1), Off (0)
2023	Over Frequency Shutdown Trip	0.0 Hz
2024	CT Primary	0 A
2025	CT Secondary	1 A, 5 A
2026	Full Load Rating	0 A
2027	Immediate Over Current	On (1), Off (0)
2028	Delayed Over Current Alarm	On (1), Off (0)
2029	Delayed Over Current Alarm Action	0 (Action)
2030	Over Current Delay	00:00:00
2031	Over Current Trip	0 %
2032	Generator kW Rating	0 kW
2033	Overload Protection Enable	On (1), Off (0)
2034	Overload Protection Action	0 (Action)
2035	Overload Protection Trip	0 %
2036	Overload Protection Trip Delay	0 s
2037	AC System	0 (AC system)
2038	Mains Failure Detection	On (1), Off (0)
2039	Immediate Mains Dropout	On (1), Off (0)
2040	Mains Under Voltage Enable	On (1), Off (0)
2041	Mains Under Voltage Trip	0 V
2042	Mains Under Voltage Return	0 V
2043	Mains Over Voltage Enable	On (1), Off (0)
2044	Mains Over Voltage Return	0 V
2045	Mains Over Voltage Trip	0 V
2046	Mains Under Frequency Enable	On (1), Off (0)
2047	Mains Under Frequency Trip	0.0 Hz
2048	Mains Under Frequency Return	0.0 Hz

Continued overleaf...

Front Panel Configuration

	Functionality in DSE4510 MKII & DSE4520 MKII
	Functionality in DSE4520 MKII only.

Configuration Parameters – Alternative Configuration 1 (Page 20)		
2049	Mains Over Frequency Enable	On (1), Off (0)
2050	Mains Over Frequency Return	0.0 Hz
2051	Mains Over Frequency Trip	0.0 Hz
2052	Under Speed Shutdown Enable	On (1), Off (0)
2053	Under Speed Shutdown Trip	0 RPM
2054	Over Speed Shutdown Trip	0 RPM
2055	Mains AC System	0 (AC system)
2056	Overload Protection Return	0 %
2057	Generator Nominal Voltage	0 V

6.5.14 ALTERNATIVE CONFIGURATION 2 SETTINGS

	Functionality in DSE4510 MKII & DSE4520 MKII
	Functionality in DSE4520 MKII only.

Configuration Parameters – Alternative Configuration 2 (Page 30)		
3002	Enable Configuration	On (1), Off (0)
3003	CAN Alternative Engine Speed	On (1), Off (0)
3004	Under Voltage Shutdown Enable	On (1), Off (0)
3005	Under Voltage Shutdown Trip	0 V
3006	Under Voltage Warning Enable	On (1), Off (0)
3007	Under Voltage Warning Trip	0 V
3008	Loading Voltage	0 V
3009	Over Voltage Warning Enable	On (1), Off (0)
3010	Over Voltage Warning Return	0 V
3011	Over Voltage Warning Trip	0 V
3012	Over Voltage Trip	0 V
3013	Under Frequency Shutdown Enable	On (1), Off (0)
3014	Under Frequency Shutdown Trip	0.0 Hz
3015	Under Frequency Warning Enable	On (1), Off (0)
3016	Under Frequency Warning Trip	0.0 Hz
3017	Loading Frequency	0.0 Hz
3018	Nominal Frequency	0.0 Hz
3019	Over Frequency Warning Enable	On (1), Off (0)
3020	Over Frequency Warning Return	0.0 Hz
3021	Over Frequency Warning Trip	0.0 Hz
3022	Over Frequency Shutdown Enable	On (1), Off (0)
3023	Over Frequency Shutdown Trip	0.0 Hz
3024	CT Primary	0 A
3025	CT Secondary	1 A, 5 A
3026	Full Load Rating	0 A
3027	Immediate Over Current	On (1), Off (0)
3028	Delayed Over Current Alarm	On (1), Off (0)
3029	Delayed Over Current Alarm Action	0 (Action)
3030	Over Current Delay	00:00:00
3031	Over Current Trip	0 %
3032	Generator kW Rating	0 kW
3033	Overload Protection Enable	On (1), Off (0)
3034	Overload Protection Action	0 (Action)
3035	Overload Protection Trip	0 %
3036	Overload Protection Trip Delay	0 s
3037	AC System	0 (AC system)
3038	Mains Failure Detection	On (1), Off (0)
3039	Immediate Mains Dropout	On (1), Off (0)
3040	Mains Under Voltage Enable	On (1), Off (0)
3041	Mains Under Voltage Trip	0 V
3042	Mains Under Voltage Return	0 V
3043	Mains Over Voltage Enable	On (1), Off (0)
3044	Mains Over Voltage Return	0 V
3045	Mains Over Voltage Trip	0 V
3046	Mains Under Frequency Enable	On (1), Off (0)
3047	Mains Under Frequency Trip	0.0 Hz
3048	Mains Under Frequency Return	0.0 Hz

Continued overleaf...

Front Panel Configuration

	Functionality in DSE4510 MKII & DSE4520 MKII
	Functionality in DSE4520 MKII only.

Configuration Parameters – Alternative Configuration 2 (Page 30)		
3049	Mains Over Frequency Enable	On (1), Off (0)
3050	Mains Over Frequency Return	0.0 Hz
3051	Mains Over Frequency Trip	0.0 Hz
3052	Under Speed Shutdown Enable	On (1), Off (0)
3053	Under Speed Shutdown Trip	0 RPM
3054	Over Speed Shutdown Trip	0 RPM
3055	Mains AC System	0 (AC system)
3056	Overload Protection Return	0 %
3057	Generator Nominal Voltage	0 V

6.5.15 ALTERNATIVE CONFIGURATION 3 SETTINGS

	Functionality in DSE4510 MKII & DSE4520 MKII
	Functionality in DSE4520 MKII only.

Configuration Parameters – Alternative Configuration 3 (Page 40)		
4002	Enable Configuration	On (1), Off (0)
4003	CAN Alternative Engine Speed	On (1), Off (0)
4004	Under Voltage Shutdown Enable	On (1), Off (0)
4005	Under Voltage Shutdown Trip	0 V
4006	Under Voltage Warning Enable	On (1), Off (0)
4007	Under Voltage Warning Trip	0 V
4008	Loading Voltage	0 V
4009	Over Voltage Warning Enable	On (1), Off (0)
4010	Over Voltage Warning Return	0 V
4011	Over Voltage Warning Trip	0 V
4012	Over Voltage Trip	0 V
4013	Under Frequency Shutdown Enable	On (1), Off (0)
4014	Under Frequency Shutdown Trip	0.0 Hz
4015	Under Frequency Warning Enable	On (1), Off (0)
4016	Under Frequency Warning Trip	0.0 Hz
4017	Loading Frequency	0.0 Hz
4018	Nominal Frequency	0.0 Hz
4019	Over Frequency Warning Enable	On (1), Off (0)
4020	Over Frequency Warning Return	0.0 Hz
4021	Over Frequency Warning Trip	0.0 Hz
4022	Over Frequency Shutdown Enable	On (1), Off (0)
4023	Over Frequency Shutdown Trip	0.0 Hz
4024	CT Primary	0 A
4025	CT Secondary	1 A, 5 A
4026	Full Load Rating	0 A
4027	Immediate Over Current	On (1), Off (0)
4028	Delayed Over Current Alarm	On (1), Off (0)
4029	Delayed Over Current Alarm Action	0 (Action)
4030	Over Current Delay	00:00:00
4031	Over Current Trip	0 %
4032	Generator kW Rating	0 kW
4033	Overload Protection Enable	On (1), Off (0)
4034	Overload Protection Action	0 (Action)
4035	Overload Protection Trip	0 %
4036	Overload Protection Trip Delay	0 s
4037	AC System	0 (AC system)
4038	Mains Failure Detection	On (1), Off (0)
4039	Immediate Mains Dropout	On (1), Off (0)
4040	Mains Under Voltage Enable	On (1), Off (0)
4041	Mains Under Voltage Trip	0 V
4042	Mains Under Voltage Return	0 V
4043	Mains Over Voltage Enable	On (1), Off (0)
4044	Mains Over Voltage Return	0 V
4045	Mains Over Voltage Trip	0 V
4046	Mains Under Frequency Enable	On (1), Off (0)
4047	Mains Under Frequency Trip	0.0 Hz
4048	Mains Under Frequency Return	0.0 Hz

Continued overleaf...

Front Panel Configuration

	Functionality in DSE4510 MKII & DSE4520 MKII
	Functionality in DSE4520 MKII only.

Configuration Parameters – Alternative Configuration 3 (Page 40)		
4049	Mains Over Frequency Enable	On (1), Off (0)
4050	Mains Over Frequency Return	0.0 Hz
4051	Mains Over Frequency Trip	0.0 Hz
4052	Under Speed Shutdown Enable	On (1), Off (0)
4053	Under Speed Shutdown Trip	0 RPM
4054	Over Speed Shutdown Trip	0 RPM
4055	Mains AC System	0 (AC system)
4056	Overload Protection Return	0 %
4057	Generator Nominal Voltage	0 V

6.6 SELECTABLE PARAMETERS

6.6.1 INPUT SOURCES

	Functionality in DSE4510 MKII & DSE4520 MKII
	Functionality in DSE4520 MKII only.

Input Sources	
0	User Configured
1	Remote Start On Load
2	RESERVED
3	Auto Start Inhibit
4	Lamp Test
5	Alarm Mute
6	Alarm Reset
7	RESERVED
8	Simulate Start Button
9	Simulate Stop Button
10	RESERVED
11	Simulate Auto Button
12	RESERVED
13	Close Generator
14	Generator Load Inhibit
15	RESERVED
16	Close Mains
17	Mains Load Inhibit
18	RESERVED
19	External Panel Lock
20	Auxiliary Mains Fail
21	Oil Pressure Switch
22	Coolant Temperature Switch
23	RESERVED
24	Simulate Mains Available
25	Remote Start Off Load
26-30	RESERVED
31	Auto Restore Inhibit
32	RESERVED
33	Low Fuel Level Switch
34	Smoke Limiting
35-38	RESERVED
39	Main Configuration
40	Alternative Configuration 1
41	Alternative Configuration 2
42	Alternative Configuration 3
43	Emergency Stop
44	RESERVED
45	Maintenance Reset Oil
46	Maintenance Reset Air
47	Maintenance Reset Fuel
48	RESERVED
49	RESERVED
50	DPF Auto Regen Inhibit
51	DPF Force Regeneration
52	DPF Regeneration Interlock
53	Water in Fuel
54	Fuel Bund Level High
55	Fan Speed Low

6.6.2 OUTPUT SOURCES

	Functionality in DSE4510 MKII & DSE4520 MKII
	Functionality in DSE4520 MKII only.

Output Sources	
0	Not Used
1	Air Flap Relay
2	Audible Alarm
3	Battery High Volts Warning
4	Battery Low Volts Warning
5	CAN ECU Data Fail
6	ECU (ECM) Warning
7	ECU (ECM) Shutdown
8	CAN ECU Power
9	CAN ECU Stop
10	Charge Alternator Shutdown
11	Charge Alternator Warning
12	Close Gen Output
13	Close Gen Output Pulse
14	Close Mains Output
15	Close Mains Output Pulse
16	Combined Mains Failure
17	Common Alarm
18	Common Electrical Trip
19	Common Shutdown
20	Common Warning
21	Cooling Down
22	Digital Input A
23	Digital Input B
24	Digital Input C
25	Digital Input D
26	RESERVED
27	RESERVED
28	RESERVED
29	Emergency Stop
30	Energise To Stop
31	Fail To Start
32	Fail To Stop
33	Fuel Relay
34	Gas Choke On
35	Gas Ignition
36	Generator Available
37	Generator High Voltage Alarm
38	Generator Low Voltage Alarm
39	kW Overload Alarm
40	Over Current Immediate Warning
41	Delayed Over Current Alarm
42	High Coolant Temperature Shutdown
43	Low Oil Pressure Shutdown
44	Mains High Frequency
45	Mains High Voltage
46	Mains Low Frequency
47	Mains Low Voltage
48	Oil Pressure Sensor Open Circuit

Continued overleaf...

Front Panel Configuration

	Functionality in DSE4510 MKII & DSE4520 MKII
	Functionality in DSE4520 MKII only.

Output Sources	
49	Open Gen Output
50	Open Gen Output Pulse
51	Open Mains Output
52	Open Mains Output Pulse
53	Over Frequency Shutdown
54	Over Speed Shutdown
55	Preheat During Preheat Timer
56	Preheat Until End Of Crank
57	Preheat Until End Of Safety Timer
58	Preheat Until End Of Warming
59	Smoke Limiting
60	Start Relay
61	Temperature Sensor Open Circuit
62	Under Frequency Shutdown
63	Under Speed Shutdown
64	Waiting For Manual Restore
65	Flexible Sensor C High Alarm
66	Flexible Sensor C High Pre-Alarm
67	Flexible Sensor C Low Pre-Alarm
68	Flexible Sensor C Low Alarm
69	RESERVED
70	RESERVED
71	RESERVED
72	RESERVED
73	Fuel Sensor High Alarm
74	Fuel Sensor High Pre-Alarm
75	Fuel Sensor Low Pre-Alarm
76	Fuel Sensor Low Alarm
77	Delayed Load Output 1
78	Delayed Load Output 2
79	Delayed Load Output 3
80	Delayed Load Output 4
81	Air Filter Maintenance Output
82	Oil Filter Maintenance Output
83	Fuel Filter Maintenance Output
84	System In Stop Mode
85	System In Auto Mode
86	System In Manual Mode
87	RESERVED
88	Analogue Input A (Digital)
89	Analogue Input B (Digital)
90	Analogue Input C (Digital)
91	RESERVED
92	RESERVED
93	RESERVED
94	RESERVED
95	Over Speed Overshoot
96	Over Frequency Overshoot
97	Display Heater Fitted and Active
98	RESERVED
99	SCR Inducement

Continued overleaf...

Front Panel Configuration

	Functionality in DSE4510 MKII & DSE4520 MKII
	Functionality in DSE4520 MKII only.

Output Sources	
100	DEF Level Low
101	DPF Auto Regeneration Inhibit
102	DPF Forced Regeneration
103	DPF None Mission State
104	DPF Regeneration in Progress
105	DPF Regeneration Interlock Active
106	DPTC Filter
107	HEST Active
108	Water in Fuel
109	Fuel Pull in Coil
110	Generator at Rest
111	Fuel Tank Bund Level High
112	ECU Preheat
113	Water Heater
114	Water Cooler
115	Closed to Generator
116	Closed to Mains
117	Gen Under Frequency Warning
118	Gen Over Frequency Warning
119	Gen Low Voltage Warning
120	Gen High Voltage Warning
121	Main Config Selected
122	Alt Config 1 Selected
123	Alt Config 2 Selected
124	Alt Config 3 Selected
125	Flexible Sensor A High Alarm
126	Flexible Sensor A High Pre-Alarm
127	Flexible Sensor A Low Alarm
128	Flexible Sensor A Low Pre-Alarm
129	Flexible Sensor A Open Circuit
130	Fan Speed Low
131	Fuel Usage Alarm
132	Low Coolant Level
133	Low Coolant Level Open Circuit
134	Waiting to Start
135	High Coolant Temperature Pre-Alarm

6.6.3 ALARM ACTION

Alarm Action	
Index	Action
0	Electrical Trip
1	Shutdown
2	Warning

6.6.4 POWER UP MODE

Power Up Mode	
Index	Mode
0	Stop
1	Manual
2	Auto

6.6.5 AC SYSTEM

AC System	
Index	Type
0	2 Phase 3 Wire (L1-L3)
1	2 Phase 3 Wire (L1-L2)
2	3 Phase 3 Wire
3	3 Phase 4 Wire
4	3 Phase 4 Wire (Delta)
5	Single Phase 2 Wire

6.6.6 DIGITAL INPUT ALARM ARMING

Digital Input Alarm Arming	
Index	Arming
0	Always
1	From Safety On
2	From Starting
3	Never

6.6.7 DIGITAL INPUT POLARITY

Digital Input Polarity	
Index	Polarity
0	Close to Activate
1	Open to Activate





6.6.8 OUTPUT POLARITY

Output Polarity	
Index	Polarity
0	Energise
1	De-Energise

7 COMMISSIONING

NOTE: If Emergency Stop feature is not required, link the input to the DC Negative or disable the input. For further details of module configuration, refer to DSE Publication: 057-258 *DSE4510 MKII & DSE4520 MKII Configuration Software Manual*.

Before the system is started, it is recommended that the following checks are made:

- The unit is adequately cooled and all the wiring to the module is of a standard and rating compatible with the system. Check all mechanical parts are fitted correctly and that all electrical connections (including earths) are sound.
- The unit DC supply is fused and connected to the battery and that it is of the correct polarity.
- The Emergency Stop input is wired to an external **normally closed** switch connected to **DC negative**.
- To check the start cycle operation, take appropriate measures to prevent the engine from starting (disable the operation of the fuel solenoid). After a visual inspection to ensure it is safe to proceed, connect the battery supply. Press the **Manual/Start Mode**  button, the unit start sequence commences.
- The starter engages and operates for the pre-set crank period. After the starter motor has attempted to start the engine for the pre-set number of attempts, the LCD displays **Fail to Start** . Press the **Stop/Reset Mode**  button to reset the unit.
- Restore the engine to operational status (reconnect the fuel solenoid). Press the **Manual/Start Mode**  button. This time the engine should start, and the starter motor should disengage automatically. If not then check that the engine is fully operational (fuel available, etc.) and that the fuel solenoid is operating. The engine should now run up to operating speed. If not, and an alarm is present, check the alarm condition for validity, then check input wiring. The engine should continue to run for an indefinite period. It is possible at this time to view the engine and alternator parameters - refer to the 'Description of Controls' section of this manual.
- Press the **Auto Mode**  button, the engine runs for the pre-set cooling down period, then stop. The generator should stay in the standby mode. If it does not, check that the *Remote Start* input is not active.
- Initiate an automatic start by supplying the remote start signal (if configured). The start sequence commences, and the engine runs up to operational speed. Once the generator is available the delayed load outputs activate, the Generator accepts the load. If not, check the wiring to the delayed load output contactors. Check the Warming timer has timed out.
- Remove the remote start signal. The return sequence begins. After the pre-set time, the generator is unloaded. The generator then runs for the pre-set cooling down period, then shutdown into its standby mode.
- Set the modules internal clock/calendar to ensure correct operation of the scheduler and event logging functions. For details of this procedure see section entitled *Front Panel Configuration*.
- If, despite repeated checking of the connections between the controller and the customer's system, satisfactory operation cannot be achieved, then contact DSE Technical Support Department. E-mail: support@deepseaelectronics.com

8 CAN INTERFACE SPECIFICATION (J1939-75)

The ECU port is used for live operational communications between the *DSE45XX MKII* and other CAN enabled devices. The specification below details all broadcast messages which are transmitted when the J1939-75 is enabled, and the relevant engine file is selected.

Parameter	Description
Protocol	S.A.E. J1939 with PGNs as listed in the following subsections.
Bit Rate	250 kb/s
Isolation	±2.5 kV
Termination	120 Ω termination resistor, with the option for direct PCB installation.

8.1 BROADCAST MESSAGES J1939-75

NOTE: All broadcast CAN messages are priority 3 by default, it is not possible to change the priority of the configurable CAN messages. For further details of module configuration, refer to DSE Publication: *057-258 DSE4510 MKII & DSE4520 MKII Configuration Suite PC Software Manual*.

Parameter Groups below are broadcast by the module and are detailed in the following subsections.

NOTE: SPNs that are not implemented in the module have all bits set to '1'.

NOTE: *PDU Format* and *PDU Specific* are shown in Hexadecimal.

NOTE: Values larger than 8 bits utilise *Little-Endian* format. For example, a 16 bit value, occupying two Bytes has Byte1 as the most significant Byte and Byte2 as the least significant Byte.

8.1.1 ACS - AC SWITCHING DEVICE STATUS

PGN 64913

Priority	Ext Data Page	Data Page	PDU Format	PDU Specific	Size (Bytes)	Rate
3	0	0	FD	91	8	250 ms

SPN						
Hex	Decimal	Instrument	Byte / Bit	Scaling	Offset	Units
0DD9	3545	Generator Breaker Status - This parameter indicates the measured state of the generator circuit breaker	Byte 1 Bits 1 to 3	000: Open 001: Closed 010: Locked Out 011-101: Available for SAE assignment 110: Error 111: Not available	0	N/A
0DDA	3546	Utility Circuit Breaker Status - This parameter indicates the measured state of the utility circuit breaker.	Byte 1 Bits 4 to 6	000: Open 001: Closed 010: Locked Out 011-101: Available for SAE assignment 110: Error 111: Not available	0	N/A

8.1.2 GC1 - GENERATOR CONTROL 1

PGN 64915

Priority	Ext Data Page	Data Page	PDU Format	PDU Specific	Size (Bytes)	Rate
3	0	0	FD	93	8	100 ms

SPN						
Hex	Decimal	Instrument	Byte / Bit	Scaling	Offset	Units
0DEF	3567	Generator Control Not In Automatic Start State - This parameter indicates whether the generator set is in a condition to automatically start up and provide power. If not, this status parameter is in the ACTIVE state.	Byte 1 Bits 4 to 5	00: Inactive (ready to start automatically) 01: Active (not ready to start automatically) 10: Error 11: Not available	0	N/A

8.1.3 GAAC - GENERATOR AVERAGE BASIC AC QUANTITIES

PGN 65030

Priority	Ext Data Page	Data Page	PDU Format	PDU Specific	Size (Bytes)	Rate
3	0	0	FE	06	8	100 ms

SPN						
Hex	Decimal	Instrument	Byte / Bit	Scaling	Offset	Units
0988	2440	Generator Avg. L-L AC Voltage	Byte 1 to 2	1	0	V
098C	2444	Generator Avg. L-N AC Voltage	Byte 3 to 4	1	0	V
0984	2436	Generator Avg. AC Frequency	Byte 5 to 6	1/128 Hz/bit	0	Hz
0990	2448	Generator Avg. AC RMS Current	Byte 7 to 8	1	0	A

8.1.4 GPAAC - GENERATOR PHASE A BASIC AC QUANTITIES

PGN 65027

Priority	Ext Data Page	Data Page	PDU Format	PDU Specific	Size (Bytes)	Rate
3	0	0	FE	03	8	100 ms

SPN						
Hex	Decimal	Instrument	Byte / Bit	Scaling	Offset	Units
0985	2437	Generator Phase A AC Frequency	Byte 5 to 6	128	0	V
0989	2441	Generator Phase A Line Line AC RMS Voltage	Byte 1 to 2	1	0	V
098D	2445	Generator Phase A Line Neutral AC RMS Voltage	Byte 3 to 4	1	0	A
0991	2449	Generator Phase A AC RMS Current	Byte 7 to 8	1	0	Hz

8.1.5 GPAACP - GENERATOR PHASE A AC POWER

PGN 65026

Priority	Ext Data Page	Data Page	PDU Format	PDU Specific	Size (Bytes)	Rate
3	0	0	FE	02	8	100 ms

SPN						
Hex	Decimal	Instrument	Byte / Bit	Scaling	Offset	Units
0993	2453	Generator Phase A Real Power	Byte 1 to 4	1	-2*10 ⁹	W
099D	2461	Generator Phase A Apparent Power	Byte 5 to 8	1	-2*10 ⁹	W

8.1.6 GPAACR - GENERATOR PHASE A AC REACTIVE POWER

PGN 65025

Priority	Ext Data Page	Data Page	PDU Format	PDU Specific	Size (Bytes)	Rate
3	0	0	FE	00	8	100 ms

SPN						
Hex	Decimal	Instrument	Byte / Bit	Scaling	Offset	Units
0999	2457	Generator Phase A Reactive Power	Byte 1 to 4	1	-2*10 ⁹	Var

8.1.7 GPBAC - GENERATOR PHASE B BASIC AC QUANTITIES

PGN 65024

Priority	Ext Data Page	Data Page	PDU Format	PDU Specific	Size (Bytes)	Rate
3	0	0	FE	00	8	100 ms

SPN						
Hex	Decimal	Instrument	Byte / Bit	Scaling	Offset	Units
0986	2438	Generator Phase B AC Frequency	Byte 5 to 6	0.0078125	0	Hz
098A	2442	Generator Phase B Line Line AC RMS Voltage	Byte 1 to 2	1	0	V
098E	2446	Generator Phase B Line Neutral AC RMS Voltage	Byte 3 to 4	1	0	V
0992	2450	Generator Phase B AC RMS Current	Byte 7 to 8	1	0	A

8.1.8 GPBACP - GENERATOR PHASE B AC POWER

PGN 65023

Priority	Ext Data Page	Data Page	PDU Format	PDU Specific	Size (Bytes)	Rate
3	0	0	FD	FF	8	100 ms

SPN						
Hex	Decimal	Instrument	Byte / Bit	Scaling	Offset	Units
0996	2454	Generator Phase B Real Power	Byte 1 to 4	1	-2*10 ⁹	W
099E	2462	Generator Phase B Apparent Power	Byte 5 to 8	1	-2*10 ⁹	W

8.1.9 GPBACR - GENERATOR PHASE B AC REACTIVE POWER

PGN 65022

Priority	Ext Data Page	Data Page	PDU Format	PDU Specific	Size (Bytes)	Rate
3	0	0	FD	FE	8	100 ms

SPN						
Hex	Decimal	Instrument	Byte / Bit	Scaling	Offset	Units
099A	2458	Generator Phase B Reactive Power	Byte 1 to 4	1	-2*10 ⁹	Var

8.1.10 GPCAC - GENERATOR PHASE C BASIC AC QUANTITIES

PGN 65021

Priority	Ext Data Page	Data Page	PDU Format	PDU Specific	Size (Bytes)	Rate
3	0	0	FD	FD	8	100 ms

SPN						
Hex	Decimal	Instrument	Byte / Bit	Scaling	Offset	Units
0987	2439	Generator Phase C AC Frequency	Byte 5 to 6	0.0078125	0	Hz
098B	2443	Generator Phase C Line Line AC RMS Voltage	Byte 1 to 2	1	0	V
098F	2447	Generator Phase C Line Neutral AC RMS Voltage	Byte 3 to 4	1	0	V
0993	2451	Generator Phase C AC RMS Current	Byte 7 to 8	1	0	A

8.1.11 GPCACP - GENERATOR PHASE C AC POWER

PGN65020

Priority	Ext Data Page	Data Page	PDU Format	PDU Specific	Size (Bytes)	Rate
3	0	0	FD	FF	8	100 ms

SPN						
Hex	Decimal	Instrument	Byte / Bit	Scaling	Offset	Units
0997	2455	Generator Phase C Real Power	Byte 1 to 4	1	-2*10 ⁹	W
099F	2463	Generator Phase C Apparent Power	Byte 5 to 8	1	-2*10 ⁹	W

8.1.12 GPCACR - GENERATOR PHASE C AC REACTIVE POWER

PGN 65019

Priority	Ext Data Page	Data Page	PDU Format	PDU Specific	Size (Bytes)	Rate
3	0	0	FD	FB	8	100 ms

SPN						
Hex	Decimal	Instrument	Byte / Bit	Scaling	Offset	Units
099B	2459	Generator Phase C Reactive Power	Byte 1 to 4	1	-2*10 ⁹	Var

8.1.13 GTACPP - GENERATOR TOTAL AC PERCENT POWER

PGN 64911

Priority	Ext Data Page	Data Page	PDU Format	PDU Specific	Size (Bytes)	Rate
3	0	0	FD	8F	8	250 ms

SPN						
Hex	Decimal	Instrument	Byte / Bit	Scaling	Offset	Units
0E06	3590	Generator Total Percent kW as a percentage of rated power	Byte 1 to 2	0.0078125	-251	%

8.1.14 GTACE - GENERATOR TOTAL KW HOURS EXPORT

PGN 65018

Priority	Ext Data Page	Data Page	PDU Format	PDU Specific	Size (Bytes)	Rate
3	0	0	FD	FA	8	100 ms

SPN						
Hex	Decimal	Instrument	Byte / Bit	Scaling	Offset	Units
09A4	2468	Generator Total kW Hours Export	Byte 1 to 4	1	0	kWh

8.1.15 GTACER - GENERATOR TOTAL AC REACTIVE ENERGY

PGN64910

Priority	Ext Data Page	Data Page	PDU Format	PDU Specific	Size (Bytes)	Rate
3	0	0	FD	8E	8	250 ms

SPN						
Hex	Decimal	Instrument	Byte / Bit	Scaling	Offset	Units
0E09	3593	Generator Total kvar Hours Export	Byte 1 to 4	1	0	kvarh

8.1.16 GTACP - GENERATOR TOTAL AC POWER

PGN65029

Priority	Ext Data Page	Data Page	PDU Format	PDU Specific	Size (Bytes)	Rate
3	0	0	FE	05	8	100 ms

SPN						
Hex	Decimal	Instrument	Byte / Bit	Scaling	Offset	Units
0994	2452	Generator Total Real Power	Byte 1 to 4	1	-2*10 ⁹	W
099C	2460	Generator Total Apparent Power	Byte 5 to 8	1	-2*10 ⁹	VA

8.1.17 GTACR - GENERATOR TOTAL AC REACTIVE POWER

PGN65028

Priority	Ext Data Page	Data Page	PDU Format	PDU Specific	Size (Bytes)	Rate
3	0	0	FE	04	8	100 ms

SPN						
Hex	Decimal	Instrument	Byte / Bit	Scaling	Offset	Units
0988	2456	Generator Total Reactive Power	Byte 1 to 4	1	-2*10 ⁹	var
09A0	2464	Generator Overall Power Factor	Byte 5 to 6	-1	6.103515625E-05	pF
09D6	2518	Generator Overall Power Factor Lagging	Byte 7 to 8	1	0	+/-

8.2 BROADCAST MESSAGES ENGINE INSTRUMENTATION

 **NOTE:** The availability of the Engine Instrumentation PGNs are dependent upon the engine file selected within the DSE module's configuration. Contact DSE technical support: support@deepseaelectronics.com for more information.

8.2.1 DD - DASH DISPLAY

PGN 65276

Priority	Ext Data Page	Data Page	PDU Format	PDU Specific	Size (Bytes)	Rate
3	0	0	FE	FC	8	1000 ms

SPN						
Hex	Decimal	Instrument	Byte / Bit	Scaling	Offset	Units
060	96	Ratio of volume of fuel to the total volume of fuel storage container.	Byte 2	0.4	0	%

8.2.2 EC2 - ENGINE CONFIGURATION 2**PGN64895**

Priority	Ext Data Page	Data Page	PDU Format	PDU Specific	Size (Bytes)	Rate
3	0	0	FD	7F	8	Request

SPN							
Hex	Decimal	Instrument	Byte / Bit	Scaling	Offset	Units	
0E56	3670	Maximum Crank Attempts per Start Attempt	Byte 1	1	0	N/A	

8.2.3 EEC1- ENGINE SPEED**PGN61444**

Priority	Ext Data Page	Data Page	PDU Format	PDU Specific	Size (Bytes)	Rate
3	0	0	F0	04	8	100 ms

SPN							
Hex	Decimal	Instrument	Byte / Bit	Scaling	Offset	Units	
0BE	190	Engine Speed	Byte 4 - 5	0.125	0	RPM	

8.2.4 EEC4 - CRANK ATTEMPT COUNT ON PRESENT START ATTEMPT**PGN65214**

Priority	Ext Data Page	Data Page	PDU Format	PDU Specific	Size (Bytes)	Rate
3	0	0	FE	FB	8	Request

SPN							
Hex	Decimal	Instrument	Byte / Bit	Scaling	Offset	Units	
0E57	3671	Crank Attempt Count on Present Start Attempt	Byte 6	1	0	N/A	

8.2.5 EFL_P1 - OIL PRESSURE**PGN65263**

Priority	Ext Data Page	Data Page	PDU Format	PDU Specific	Size (Bytes)	Rate
3	0	0	FE	EF	8	500 ms

SPN							
Hex	Decimal	Instrument	Byte / Bit	Scaling	Offset	Units	
064	100	Oil Pressure	Byte 4	4	0	kPa	

8.2.6 EOI - EMERGENCY STOP

PGN64914

Priority	Ext Data Page	Data Page	PDU Format	PDU Specific	Size (Bytes)	Rate
3	0	0	FD	92	8	250 ms

SPN						
Hex	Decimal	Instrument	Byte / Bit	Scaling	Offset	Units
0E17	3607	Emergency Stop 00: Off (No Shutdown Requested) 01: On (Shutdown Requested) 10: Reserved 11: Don't care / take no action	Byte 6 Bit 6 - 8	1	0	N/A

8.2.7 ET1 - COOLANT TEMPERATURE

PGN65262

Priority	Ext Data Page	Data Page	PDU Format	PDU Specific	Size (Bytes)	Rate
3	0	0	FE	EE	8	1000 ms

SPN						
Hex	Decimal	Instrument	Byte / Bit	Scaling	Offset	Units
06E	110	Engine Coolant Temperature	Byte 1	1	-40	°C

8.2.8 HOURS - ENGINE HOURS REVOLUTIONS

PGN65253

Priority	Ext Data Page	Data Page	PDU Format	PDU Specific	Size (Bytes)	Rate
3	0	0	FE	E5	8	Request

SPN						
Hex	Decimal	Instrument	Byte / Bit	Scaling	Offset	Units
0F7	247	Engine Total Hours of Operation	Byte 1 -4	0.05	0	hr

8.2.9 VEP1 - VEHICLE ELECTRICAL POWER

PGN65271

Priority	Ext Data Page	Data Page	PDU Format	PDU Specific	Size (Bytes)	Rate
3	0	0	FE	F7	8	1000 ms

SPN						
Hex	Decimal	Instrument	Byte / Bit	Scaling	Offset	Units
0A7	167	Charge Alternator Voltage	Byte 3 to 4	0.05	0	V
0A8	168	Plant Battery Voltage	Byte 5 to 6	0.05	0	V

8.3 DM01 - CONDITIONS ACTIVE DIAGNOSTIC TROUBLE CODES

NOTE: The availability of the Engine Alarm SPN and FMI is dependent upon the engine file selected within the DSE module's configuration. Contact DSE technical support: support@deepseaelectronics.com for more information.

NOTE: If only one DM1 alarm is active the DM1 priority will remain as six. If two or more DM1 alarms are active the priority will be seven.

PGN65226

Priority	Ext Data Page	Data Page	PDU Format	PDU Specific	Size (Bytes)	Rate
6/7	0	0	FE	CA	8	1000 ms

SPN						
Hex	Decimal	Instrument	Byte / Bit	Scaling	Offset	Units
04BE	1214	Suspect Parameter Number	Byte 3 Bits 1 to 19	1	0	N/A
04BF	1215	Failure Mode Identifier	Byte 5 Bits 1 to 5	1	0	N/A
06AA	1706	SPN Conversion Method	Byte 6 Bit 7	1	0	N/A

DM1 Conditions

Key	Value
Low Fault - Least Severe	17
High Fault - Least Severe	15
Low Fault - Most Severe	1
High Fault - Most Severe	0
Erratic - Incorrect Data	2



Generator Alarm Condition	SPN	Warning FMI	Shutdown FMI
Generator Average AC Frequency Under	2436	17	1
SPN Generator Average Line-Line AC RMS Voltage Over	2436	15	0
Generator Average Line-Line AC RMS Voltage Under	2440	17	1
Generator Average Line-Line AC RMS Voltage Over	2440	15	0
Generator Average Line-Neutral AC RMS Voltage Under	2444	17	1
Generator Average Line-Neutral AC RMS Voltage Over	2444	15	0
Generator Average AC RMS Current Over	2448	15	0

Engine Alarm Condition	SPN	Warning FMI	Shutdown FMI
Fuel Level Low	96	17	1
Oil Pressure Low (Analogue Sensor)	100	17	1
Oil Pressure Low (Digital Input)	100	17	1
Oil Pressure Sensor Fault	100	2	2
Coolant Temperature High (Analogue Sensor)	110	15	0
Coolant Temperature High (Digital Input)	110	15	0
Coolant Temperature Sensor Fault	110	2	2
Charge Alternator Failed	167	17	1
Plant Battery Voltage High	168	15	0
Plant Battery Voltage Low	168	17	1
Overspeed	190	15	0
Underspeed	190	17	1



9 FAULT FINDING

 **NOTE:** The below fault finding is provided as a guide check-list only. As the module can be configured to provide a wide range of different features, always refer to the source of the module configuration if in doubt.







9.1 STARTING

Symptom	Possible Remedy
Unit is inoperative	Check the battery and wiring to the unit. Check the DC supply. Check the DC fuse.
Read/Write configuration does not operate	
Unit shuts down	Check DC supply voltage is not above 35 Volts or below 9 Volts Check the operating temperature is not above 70°C. Check the DC fuse.
Fail to Start  is activated after pre-set number of attempts to start	Check wiring of fuel solenoid. Check fuel. Check battery supply. Check battery supply is present on the Fuel output of the module. Check the speed-sensing signal is present on the module's inputs. Refer to engine manual.
Continuous starting of generator when in the Auto Mode 	Check that there is no signal present on the "Remote Start" input. Check configured polarity is correct.
Generator fails to start on receipt of Remote Start signal.	Check Start Delay timer has timed out. Check signal is on "Remote Start" input. Confirm correct configuration of input is configured to be used as "Remote Start". Check that the oil pressure switch or sensor is indicating low oil pressure to the controller. Depending upon configuration, the set does not start if oil pressure is not low.
Pre-heat inoperative	Check wiring to engine heater plugs. Check battery supply. Check battery supply is present on the Pre-heat output of module. Check pre-heat configuration is correct.
Starter motor inoperative	Check wiring to starter solenoid. Check battery supply. Check battery supply is present on the Starter output of module. Ensure oil pressure switch or sensor is indicating the "low oil pressure" state to the controller.

9.2 LOADING

Symptom	Possible Remedy
Engine runs but generator does not take load	Check Warm up timer has timed out. Ensure generator load inhibit signal is not present on the module inputs. Check connections to the switching device. Note that the set does not take load in Manual/Start Mode  unless there is an active load signal.
Incorrect reading on engine gauges	Check engine is operating correctly.
Fail To Stop  when engine is at rest	Check that sensor is compatible with the module and that the module configuration is suited to the sensor.

9.3 ALARMS

Symptom	Possible Remedy
Low Oil Pressure  operates after engine has fired	Check engine oil pressure. Check oil pressure switch/sensor and wiring. Check configured polarity (if applicable) is correct (i.e. Normally Open or Normally Closed) or that sensor is compatible with the module and is correctly configured.
High Coolant Temperature  operates after engine has fired.	Check engine temperature. Check switch/sensor and wiring. Check configured polarity (if applicable) is correct (i.e. Normally Open or Normally Closed) or that sensor is compatible with the module.
Shutdown fault operates	Check relevant switch and wiring of fault indicated on LCD display. Check configuration of input.
Electrical Trip fault operates	Check relevant switch and wiring of fault indicated on LCD display. Check configuration of input.
Warning fault operates	Check relevant switch and wiring of fault indicated on LCD display. Check configuration of input.
CAN ECU Amber  CAN ECU Red 	This indicates a fault condition detected by the engine ECU and transmitted to the DSE controller.
CAN Data Fail 	Indicates failure of the CAN data link to the engine ECU. Check all wiring and termination resistors (if required).
Incorrect reading on Engine gauges	Check engine is operating correctly. Check sensor and wiring paying attention to the wiring to terminal 10.
Fail To Stop  when engine is at rest	Check that sensor is compatible with the module and that the module configuration is suited to the sensor.

9.4 COMMUNICATIONS

Symptom	Possible Remedy
CAN Data Fail 	Indicates failure of the CAN data link to the engine ECU. Check all wiring and termination resistors (if required).

9.5 INSTRUMENTS

Symptom	Possible Remedy
Inaccurate generator measurements on controller display	<p>Check that the CT primary, CT secondary and VT ratio settings are correct for the application.</p> <p>Check that the CTs are wired correctly with regards to the direction of current flow (p1, p2 and s1,s2) and additionally ensure that CTs are connected to the correct phase (errors occur if CT1 is connected to phase 2).</p> <p>Remember to consider the power factor (kW = kVA x powerfactor).</p> <p>The controller is true RMS measuring so gives more accurate display when compared with an 'averaging' meter such as an analogue panel meter or some lower specified digital multimeters.</p> <p>Accuracy of the controller is better than 1% of full scale. Generator voltage full scale is 415 V ph-N, accuracy is ± 4.15 V (1 % of 415 V).</p>

9.6 MISCELLANEOUS

Symptom	Possible Remedy
<p>Module appears to 'revert' to an earlier configuration</p>	<p>When editing a configuration using the PC software it is vital that the configuration is first 'read' from the controller before editing it. This edited configuration must then be "written" back to the controller for the changes to take effect.</p> <p>When editing a configuration using the fascia editor, be sure to press the Auto Mode  (✓) button to save the change before moving to another item or exiting the fascia editor</p>

10 MAINTENANCE, SPARES, REPAIR AND SERVICING

The controller is *Fit and Forget*. As such, there are no user serviceable parts within the controller. In the case of malfunction, you should contact your original equipment manufacturer (OEM).

10.1 PURCHASING ADDITIONAL CONNECTOR PLUGS FROM DSE

If you require additional plugs from DSE, please contact our Sales department using the part numbers below.

10.1.1 PACK OF PLUGS

Module Type	Plug Pack Part Number
DSE4510 MKII	007-878
DSE4520 MKII	007-846

10.1.2 INDIVIDUAL PLUGS

Module Terminal Designation	Plug Description	Part No.
1-9	9 way 5.08mm	007-166
10-20	11 way 5.08mm	007-451
21-24	4 way 10.16mm	007-003
25-28	DSE4520 MKII Only 4 way 10.16mm	007-003
29-32	4 way 5.08mm	007-282
	PC Configuration interface lead (USB type A – USB type B)	016-125

10.2 PURCHASING ADDITIONAL FIXING CLIPS FROM DSE

Item	Description	Part No.
	Module Fixing Clips (Packet Of 2)	020-406

10.3 PURCHASING ADDITIONAL SEALING GASKET FROM DSE

Item	Description	Part No.
	Module Silicon Sealing Gasket	020-282

11 WARRANTY

DSE Provides limited warranty to the equipment purchaser at the point of sale. For full details of any applicable warranty, refer to the original equipment supplier (OEM)

12 DISPOSAL

12.1 WEEE (WASTE ELECTRICAL AND ELECTRONIC EQUIPMENT)

If you use electrical and electronic equipment you must store, collect, treat, recycle, and dispose of WEEE separately from your other waste



This Page is Intentionally Blank