



# **DEEP SEA ELECTRONICS**

## **DSE7310 MKII & DSE7320 MKII**

### **Operator Manual**

**Document Number: 057-253**

Author: Ashley Senior





Deep Sea Electronics Ltd  
Highfield House  
Hunmanby  
North Yorkshire  
YO14 0PH  
ENGLAND

Sales Tel: +44 (0) 1723 890099

E-mail: sales@deepseaelectronics.com  
Website: www.deepseaelectronics.com

### **DSE7310 MKII & DSE7320 MKII Operator Manual**

© Deep Sea Electronics Ltd

All rights reserved. No part of this publication may be reproduced in any material form (including photocopying or storing in any medium by electronic means or other) without the written permission of the copyright holder except in accordance with the provisions of the Copyright, Designs and Patents Act 1988.

Applications for the copyright holder's written permission to reproduce any part of this publication must be addressed to Deep Sea Electronics Ltd at the address above.

The DSE logo and the names DSEGenset®, DSEAts® and DSEPower® are UK registered trademarks of Deep Sea Electronics Ltd.

Any reference to trademarked product names used within this publication is owned by their respective companies.

Deep Sea Electronics Ltd reserves the right to change the contents of this document without prior notice.

### **Amendments Since Last Publication**

<b>Amd. No.</b>	<b>Comments</b>
1	Initial Release
2	Added E-Stop spec, updated FPE information and EPA screen.
3	Added DSE2131, DSE2133, DSE2152 expansion units support and DSE Intelligent Battery Chargers support on the DSEnet. Alternative configuration edit from FPE and Fuel efficiency instrumentation support.
4	Added User Defined Strings, PLC Instruments, Configurable Can, 25xx MKII support. Updated Applicable Standards, J1939-75, Breaker Operation in Manual Mode and Alarms.
5	Updated the EPA Icons screen and J1939-75 section.
6	Updated sections ECU Port (J1939), DSENet (Expansion Modules), Typical Arrange of CAN, Configurable Status Screens, Default DPF Regeneration Lamps, Changeover Functionality (DSE7320 MKII), Protections and Front Panel Configuration.
7	Updated to match specification of DSE73xx V6.
8	Updated sections Configurable CAN, Maintenance Alarms, Module Timers and RS232 Modbus Master.

## TABLE OF CONTENTS

Section	Page
<b>1 INTRODUCTION.....</b>	<b>8</b>
1.1 CLARIFICATION OF NOTATION.....	9
1.2 GLOSSARY OF TERMS.....	9
1.3 BIBLIOGRAPHY .....	11
1.3.1 INSTALLATION INSTRUCTIONS.....	11
1.3.2 TRAINING GUIDES .....	11
1.3.3 MANUALS .....	12
1.3.4 THIRD PARTY DOCUMENTS .....	12
<b>2 SPECIFICATION.....</b>	<b>13</b>
2.1 OPERATING TEMPERATURE.....	13
2.1.1 OPTIONAL SCREEN HEATER OPERATION .....	13
2.2 REQUIREMENTS FOR UL .....	13
2.3 TERMINAL SPECIFICATION .....	14
2.4 POWER SUPPLY REQUIREMENTS.....	14
2.4.1 MODULE SUPPLY INSTRUMENTATION DISPLAY.....	14
2.5 VOLTAGE & FREQUENCY SENSING.....	15
2.6 CURRENT SENSING.....	15
2.6.1 VA RATING OF THE CTS.....	16
2.6.2 CT POLARITY .....	17
2.6.3 CT PHASING.....	17
2.6.4 CT CLASS.....	17
2.7 INPUTS.....	18
2.7.1 DIGITAL INPUTS .....	18
2.7.2 EMERGENCY STOP .....	18
2.7.3 ANALOGUE INPUTS .....	19
2.7.3.1 ANALOGUE INPUT A .....	19
2.7.3.2 ANALOGUE INPUT B .....	20
2.7.3.3 ANALOGUE INPUT C .....	20
2.7.3.4 ANALOGUE INPUT D.....	21
2.7.3.5 ANALOGUE INPUT E .....	21
2.7.3.6 ANALOGUE INPUT F .....	22
2.7.4 CHARGE FAIL INPUT.....	23
2.7.5 MAGNETIC PICK-UP .....	23
2.8 OUTPUTS.....	24
2.8.1 DC OUTPUTS A & B (FUEL & START).....	24
2.8.2 CONFIGURABLE VOLT-FREE RELAY OUTPUTS C & D.....	24
2.8.3 CONFIGURABLE DC OUTPUTS E, F, G, H, I & J .....	24
2.9 COMMUNICATION PORTS.....	25
2.10 COMMUNICATION PORT USAGE.....	26
2.10.1 USB SLAVE PORT (PC CONFIGURATION).....	26
2.10.2 RS232 PORT.....	27
2.10.2.1 RECOMMENDED EXTERNAL MODEMS.....	27
2.10.2.2 RECOMMENDED PC RS232 SERIAL PORT ADD-ONS .....	28
2.10.2.3 RS232 USED FOR DUAL MUTUAL STANDBY CONNECTION .....	29
2.10.2.4 RS232 USED FOR THE DSE25XX MKII REMOTE DISPLAY .....	30
2.10.3 RS485 PORT.....	31
2.10.3.1 CABLE SPECIFICATION.....	31
2.10.3.2 RECOMMENDED PC RS485 SERIAL PORT ADD-ONS .....	32
2.10.3.3 RS485 USED FOR MODBUS ENGINE CONNECTION .....	33
2.10.3.4 RS485 USED FOR DUAL MUTUAL STANDBY CONNECTION .....	33
2.10.3.5 RS485 USED FOR THE DSE25XX MKII REMOTE DISPLAY .....	34
2.10.4 ECU PORT (J1939).....	35
2.10.4.1 CAN SUPPORTED ENGINES.....	35
2.10.4.2 CAN SUPPORTED AVRS .....	35
2.10.4.3 J1939-75 .....	36

2.10.4.4	CONFIGURABLE CAN .....	37
2.10.5	DSENET® (EXPANSION MODULES).....	38
2.10.5.1	DSENET® USED FOR MODBUS ENGINE CONNECTION .....	39
<b>2.11</b>	<b>SOUNDER .....</b>	<b>40</b>
2.11.1	ADDING AN EXTERNAL SOUNDER .....	40
<b>2.12</b>	<b>ACCUMULATED INSTRUMENTATION .....</b>	<b>41</b>
<b>2.13</b>	<b>DIMENSIONS AND MOUNTING .....</b>	<b>42</b>
2.13.1	DIMENSIONS.....	42
2.13.2	PANEL CUTOUT.....	42
2.13.3	WEIGHT .....	42
2.13.4	FIXING CLIPS .....	43
2.13.5	CABLE TIE FIXING POINTS.....	44
2.13.6	SILICON SEALING GASKET.....	44
<b>2.14</b>	<b>APPLICABLE STANDARDS .....</b>	<b>45</b>
2.14.1	ENCLOSURE CLASSIFICATIONS .....	46
2.14.1.1	IP CLASSIFICATIONS.....	46
2.14.1.2	NEMA CLASSIFICATIONS.....	47
<b>3</b>	<b>INSTALLATION .....</b>	<b>48</b>
<b>3.1</b>	<b>USER CONNECTIONS .....</b>	<b>48</b>
<b>3.2</b>	<b>CONNECTION DESCRIPTIONS .....</b>	<b>49</b>
3.2.1	DC SUPPLY, E-STOP INPUT, DC OUTPUTS & CHARGE FAIL INPUT .....	49
3.2.2	ANALOGUE SENSOR INPUTS .....	50
3.2.3	MPU, ECU & DSENET® .....	51
3.2.4	OUTPUT C & D & V1 (GENERATOR) VOLTAGE & FREQUENCY SENSING .....	52
3.2.5	V2 (MAINS) VOLTAGE & FREQUENCY SENSING .....	52
3.2.6	CURRENT TRANSFORMERS.....	53
3.2.6.1	CT CONNECTIONS .....	54
3.2.7	DIGITAL INPUTS .....	54
3.2.8	RS485.....	55
3.2.9	RS232.....	55
3.2.10	USB SLAVE (PC CONFIGURATION) CONNECTOR .....	56
<b>3.3</b>	<b>TYPICAL WIRING DIAGRAM.....</b>	<b>57</b>
3.3.1	DSE7310 MKII (3 PHASE 4 WIRE) WITH RESTRICTED EARTH FAULT .....	58
3.3.2	DSE7320 MKII (3 PHASE 4 WIRE) WITH RESTRICTED EARTH FAULT .....	59
3.3.3	EARTH SYSTEMS .....	60
3.3.3.1	NEGATIVE EARTH.....	60
3.3.3.2	POSITIVE EARTH .....	60
3.3.3.3	FLOATING EARTH .....	60
3.3.4	TYPICAL ARRANGEMENT OF DSENET®.....	61
3.3.5	TYPICAL ARRANGEMENT OF CAN.....	62
3.3.5.1	ECU PORT .....	62
3.3.6	DUAL MUTUAL STANDBY SINGLE LINE DIAGRAMS .....	63
3.3.6.1	TWO DSE7310 MKII .....	63
3.3.6.2	TWO DSE7320 MKII .....	64
3.3.6.3	TWO DSE73XX MKII USING DIGITAL INPUTS AND OUTPUTS .....	65
<b>3.4</b>	<b>ALTERNATE TOPOLOGY WIRING DIAGRAMS .....</b>	<b>66</b>
3.4.1	SINGLE PHASE 2 WIRE WITH RESTRICTED EARTH FAULT .....	66
3.4.2	SINGLE PHASE 2 WIRE WITHOUT EARTH FAULT .....	67
3.4.3	SINGLE PHASE (L1 & L2) 3 WIRE WITH RESTRICTED EARTH FAULT.....	68
3.4.4	SINGLE PHASE (L1 & L2) 3 WIRE WITHOUT EARTH FAULT .....	69
3.4.5	SINGLE PHASE (L1 & L3) 3 WIRE WITH EESTRICTED EARTH FAULT .....	70
3.4.6	SINGLE PHASE (L1 & L3) 3 WIRE WITHOUT EARTH FAULT .....	71
3.4.7	2 PHASE (L1 & L2) 3 WIRE WITH RESTRICTED EARTH FAULT .....	72
3.4.8	2 PHASE (L1 & L2) 3 WIRE WITHOUT EARTH FAULT .....	73
3.4.9	2 PHASE (L1 & L3) 3 WIRE WITH RESTRICTED EARTH FAULT .....	74
3.4.10	2 PHASE (L1 & L3) 3 WIRE WITHOUT EARTH FAULT .....	75
3.4.11	3 PHASE 3 WIRE DETLA WITHOUT EARTH FAULT.....	76
3.4.12	3 PHASE 4 WIRE WITHOUT EARTH FAULT .....	77
3.4.13	3 PHASE 4 WIRE WITH UNRESTRICTED EARTH FAULT .....	78

3.4.14	CT LOCATION .....	79
3.4.14.1	GENERATOR .....	79
3.4.14.2	LOAD.....	80
<b>4</b>	<b>DESCRIPTION OF CONTROLS.....</b>	<b>81</b>
4.1	DSE7310 MKII.....	82
4.2	DSE7320 MKII.....	83
4.3	CONTROL PUSH BUTTONS .....	84
4.4	VIEWING THE INSTRUMENT PAGES.....	87
4.4.1	STATUS .....	88
4.4.1.1	GENERATOR LOCKED OUT.....	88
4.4.1.2	WAITING FOR GENERATOR .....	88
4.4.1.3	CONFIGURABLE STATUS SCREENS .....	89
4.4.2	ENGINE.....	90
4.4.2.1	MANUAL FUEL PUMP CONTROL.....	92
4.4.2.2	DPF REGENERATION LAMPS.....	93
4.4.3	GENERATOR.....	94
4.4.3.1	SYNCHROSCOPE (DSE7320 MKII ONLY) .....	95
4.4.4	MAINS (DSE7320 MKII ONLY).....	96
4.4.5	EXPANSION.....	97
4.4.5.1	CHARGER .....	98
4.4.6	ALARMS.....	99
4.4.6.1	ECU ALARMS (CAN FAULT CODES / DTC) .....	100
4.4.7	EVENT LOG.....	101
4.4.8	SERIAL PORT.....	102
4.4.8.1	RS232 SERIAL PORT .....	102
4.4.8.2	RS485 SERIAL PORT .....	106
4.4.9	USER DEFINED STRINGS.....	107
4.4.10	SCHEDULE.....	108
4.4.11	PLC INSTRUMENTS.....	109
4.4.12	CONFIGURABLE CAN .....	110
4.4.13	AVR CAN.....	111
4.4.13.1	AVR CURRENT DTCS .....	112
4.4.14	ABOUT .....	113
4.4.14.1	MODULE INFORMATION.....	113
4.4.14.2	DUAL MUTUAL.....	113
4.5	USER CONFIGURABLE INDICATORS .....	114
<b>5</b>	<b>OPERATION.....</b>	<b>115</b>
5.1	QUICKSTART GUIDE.....	115
5.1.1	STARTING THE ENGINE .....	115
5.1.2	STOPPING THE ENGINE .....	116
5.2	STOP/RESET MODE .....	117
5.2.1	ECU OVERRIDE .....	117
5.3	MANUAL MODE .....	118
5.3.1	STARTING SEQUENCE .....	118
5.3.2	ENGINE RUNNING.....	119
5.3.2.1	MANUAL BREAKER CONTROL DISABLED .....	119
5.3.2.2	MANUAL BREAKER CONTROL ENABLED .....	120
5.3.3	STOPPING SEQUENCE.....	120
5.4	TEST MODE.....	121
5.4.1	STARTING SEQUENCE .....	121
5.4.2	ENGINE RUNNING.....	122
5.4.3	STOPPING SEQUENCE.....	122
5.5	AUTOMATIC MODE .....	123
5.5.1	WAITING IN AUTO MODE.....	123
5.5.2	STARTING SEQUENCE .....	124
5.5.3	ENGINE RUNNING.....	125
5.5.4	STOPPING SEQUENCE.....	125
5.6	SCHEDULER .....	126
5.6.1	STOP MODE .....	126

5.6.2	MANUAL MODE.....	126
5.6.3	TEST MODE.....	126
5.6.4	AUTO MODE.....	126
<b>5.7</b>	<b>ALTERNATIVE CONFIGURATIONS.....</b>	<b>127</b>
<b>5.8</b>	<b>DUMMY LOAD / LOAD SHEDDING CONTROL.....</b>	<b>127</b>
5.8.1	DUMMY LOAD CONTROL.....	127
5.8.2	LOAD SHEDDING CONTROL.....	128
<b>5.9</b>	<b>CHANGEOVER FUNCTIONALITY (DSE7320 MKII ONLY).....</b>	<b>129</b>
5.9.1	OPEN TRANSITION WITHOUT CHECK SYNC.....	129
5.9.2	OPEN TRANSITION WITH CHECK SYNC.....	130
5.9.3	CLOSED TRANSITION WITH CHECK SYNC.....	131
<b>5.10</b>	<b>SMS CONTROL.....</b>	<b>133</b>
<b>6</b>	<b>OPERATION (DUAL MUTUAL STANDBY).....</b>	<b>134</b>
<b>6.1</b>	<b>USING TWO DSE7310 MKII.....</b>	<b>134</b>
6.1.1	BALANCING MODE: SET PRIORITY.....	135
6.1.2	BALANCING MODE: ENGINE HOURS/DUAL MUTUAL TIME.....	136
<b>6.2</b>	<b>USING TWO DSE7320 MKII.....</b>	<b>137</b>
6.2.1	BALANCING MODE: SET PRIORITY.....	138
6.2.2	BALANCING MODE: ENGINE HOURS/DUAL MUTUAL TIME.....	139
<b>7</b>	<b>PROTECTIONS.....</b>	<b>141</b>
<b>7.1</b>	<b>ALARMS.....</b>	<b>141</b>
7.1.1	PROTECTIONS DISABLED.....	142
7.1.2	ECU ALARMS (CAN FAULT CODES / DTC).....	143
<b>7.2</b>	<b>INDICATIONS.....</b>	<b>144</b>
<b>7.3</b>	<b>WARNING ALARMS.....</b>	<b>145</b>
<b>7.4</b>	<b>ELECTRICAL TRIP ALARMS.....</b>	<b>155</b>
<b>7.5</b>	<b>SHUTDOWN ALARMS.....</b>	<b>162</b>
<b>7.6</b>	<b>MAINTENANCE ALARMS.....</b>	<b>170</b>
<b>7.7</b>	<b>OVER CURRENT ALARM.....</b>	<b>172</b>
7.7.1	IMMEDIATE WARNING.....	172
7.7.2	INVERSE DEFINITE MINIMUM TIME (IDMT) ALARM.....	173
7.7.2.1	CREATING A SPREADSHEET FOR THE OVER CURRENT IDMT CURVE.....	174
<b>7.8</b>	<b>SHORT CIRCUIT IDMT ALARM.....</b>	<b>176</b>
7.8.1	CREATING A SPREADSHEET FOR THE SHORT CIRCUIT IDMT CURVE.....	177
<b>7.9</b>	<b>EARTH FAULT IDMT ALARM.....</b>	<b>179</b>
<b>7.10</b>	<b>DEFAULT CURRENT PROTECTION TRIPPING CHARACTERISTICS.....</b>	<b>181</b>
<b>8</b>	<b>FRONT PANEL CONFIGURATION.....</b>	<b>183</b>
<b>8.1</b>	<b>MAIN CONFIGURATION EDITOR.....</b>	<b>184</b>
8.1.1	ACCESSING THE MAIN CONFIGURATION EDITOR.....	184
8.1.2	ENTERING PIN.....	184
8.1.3	EDITING A PARAMETER.....	185
8.1.4	EXITING THE MAIN CONFIGURATION EDITOR.....	185
8.1.5	ADJUSTABLE PARAMETERS.....	186
<b>8.2</b>	<b>'RUNNING' CONFIGURATION EDITOR.....</b>	<b>189</b>
8.2.1	ACCESSING THE 'RUNNING' CONFIGURATION EDITOR.....	189
8.2.2	ENTERING PIN.....	189
8.2.3	EDITING A PARAMETER.....	189
8.2.4	EXITING THE 'RUNNING' CONFIGURATION EDITOR.....	190
8.2.5	RUNNING EDITOR PARAMETERS.....	190
<b>9</b>	<b>COMMISSIONING.....</b>	<b>191</b>
<b>9.1</b>	<b>BASIC CHECKS.....</b>	<b>191</b>
<b>9.2</b>	<b>CLOSED TRANSITION.....</b>	<b>192</b>
9.2.1	SYNC CHECKS.....	192
9.2.1.1	INCORRECTLY WIRED BREAKER.....	193
9.2.1.2	CORRECTLY WIRED BREAKER.....	194
<b>10</b>	<b>FAULT FINDING.....</b>	<b>195</b>
<b>10.1</b>	<b>STARTING.....</b>	<b>195</b>

<b>10.2</b>	<b>LOADING</b> .....	<b>195</b>
<b>10.3</b>	<b>ALARMS</b> .....	<b>196</b>
<b>10.4</b>	<b>COMMUNICATIONS</b> .....	<b>196</b>
<b>10.5</b>	<b>INSTRUMENTS</b> .....	<b>196</b>
<b>10.6</b>	<b>MISCELLANEOUS</b> .....	<b>197</b>
<b>11</b>	<b>CAN INTERFACE SPECIFICATION (J1939-75)</b> .....	<b>198</b>
<b>11.1</b>	<b>BROADCAST MESSAGES J1939-75</b> .....	<b>198</b>
11.1.1	ACS - AC SWITCHING DEVICE STATUS .....	199
11.1.2	GC1 - GENERATOR CONTROL 1 .....	199
11.1.3	GAAC - GENERATOR AVERAGE BASIC AC QUANTITIES .....	200
11.1.4	GPAAC - GENERATOR PHASE A BASIC AC QUANTITIES .....	200
11.1.5	GPAACP - GENERATOR PHASE A AC POWER .....	200
11.1.6	GPAACR - GENERATOR PHASE A AC REACTIVE POWER.....	201
11.1.7	GPBAC - GENERATOR PHASE B BASIC AC QUANTITIES .....	201
11.1.8	GPBACP - GENERATOR PHASE B AC POWER .....	201
11.1.9	GPBACR - GENERATOR PHASE B AC REACTIVE POWER.....	202
11.1.10	GPCAC - GENERATOR PHASE C BASIC AC QUANTITIES .....	202
11.1.11	GPCACP - GENERATOR PHASE C AC POWER .....	202
11.1.12	GPCACR - GENERATOR PHASE C AC REACTIVE POWER.....	203
11.1.13	GTACPP - GENERATOR TOTAL AC PERCENT POWER .....	203
11.1.14	GTACE - GENERATOR TOTAL KW HOURS EXPORT .....	203
11.1.15	GTACER - GENERATOR TOTAL AC REACTIVE ENERGY.....	203
11.1.16	GTACP - GENERATOR TOTAL AC POWER .....	204
11.1.17	GTACR - GENERATOR TOTAL AC REACTIVE POWER.....	204
<b>11.2</b>	<b>BROADCAST MESSAGES ENGINE INSTRUMENTATION</b> .....	<b>204</b>
11.2.1	DD - DASH DISPLAY .....	204
11.2.2	EC2 - ENGINE CONFIGURATION 2 .....	205
11.2.3	EEC1- ENGINE SPEED .....	205
11.2.4	EEC4 - CRANK ATTEMPT COUNT ON PRESENT START ATTEMPT .....	205
11.2.5	EFL_P1 - OIL PRESSURE.....	205
11.2.6	EOI - EMERGENCY STOP .....	206
11.2.7	ET1 - COOLANT TEMPERATURE .....	206
11.2.8	HOURS - ENGINE HOURS REVOLUTIONS .....	206
11.2.9	VEP1 - VEHICLE ELECTRICAL POWER.....	206
11.2.10	DM01 - CONDITIONS ACTIVE DIAGNOSTIC TROUBLE CODES.....	207
<b>12</b>	<b>MAINTENANCE, SPARES, REPAIR AND SERVICING</b> .....	<b>209</b>
<b>12.1</b>	<b>PURCHASING ADDITIONAL CONNECTOR PLUGS FROM DSE</b> .....	<b>209</b>
12.1.1	PACK OF PLUGS .....	209
12.1.2	INDIVIDUAL PLUGS .....	210
<b>12.2</b>	<b>PURCHASING ADDITIONAL FIXING CLIPS FROM DSE</b> .....	<b>210</b>
<b>12.3</b>	<b>PURCHASING ADDITIONAL SEALING GASKET FROM DSE</b> .....	<b>210</b>
<b>12.4</b>	<b>DSENET® EXPANSION MODULES</b> .....	<b>211</b>
<b>13</b>	<b>WARRANTY</b> .....	<b>213</b>
<b>14</b>	<b>DISPOSAL</b> .....	<b>213</b>
14.1	WEEE (WASTE ELECTRICAL AND ELECTRONIC EQUIPMENT) .....	213

## 1 INTRODUCTION

This document details the installation and operation requirements of the DSE7310 MKII & DSE7320 MKII modules, part of the DSE Genset® range of products.

The manual forms part of the product and should be kept for the entire life of the product. If the product is passed or supplied to another party, ensure that this document is passed to them for reference purposes.

This is not a *controlled document*. DSE do not automatically inform on updates. Any future updates of this document are included on the DSE website at [www.deepseaelectronics.com](http://www.deepseaelectronics.com)

The DSE73xx MKII series is designed to provide differing levels of functionality across a common platform. This allows the generator OEM greater flexibility in the choice of controller to use for a specific application.

The DSE73xx MKII series module has been designed to allow the operator to start and stop the generator, and if required, transfer the load to the generator either manually or automatically. Additionally, the DSE7320 MKII automatically starts and stops the generator set depending upon the status of the mains (utility) supply.

The user also has the facility to view the system operating parameters via the text LCD display.

The DSE73xx MKII module monitors the engine, indicating the operational status and fault conditions, automatically shutting down the engine and giving a true first up fault condition of an engine failure by the text LCD display.

The powerful ARM microprocessor contained within the module allows for incorporation of a range of complex features:

*Text based LCD display*

*True RMS Voltage*

*Current and Power monitoring*

*USB Communications*

*Engine parameter monitoring.*

*Fully configurable inputs for use as alarms or a range of different functions.*

*Engine ECU interface to **electronic engines**.*

*Data Logging*

Using a PC and the DSE Configuration Suite software allows alteration of selected operational sequences, timers, alarms, and operational sequences. Additionally, the module's integral front panel configuration editor allows adjustment of this information.



Access to critical operational sequences and timers for use by qualified engineers, can be protected by a security code. Module access can also be protected by PIN code. Selected parameters can be changed from the module's front panel.

The module is housed in a robust plastic case suitable for panel mounting. Connections to the module are via locking plug and sockets.



## 1.1 CLARIFICATION OF NOTATION

Clarification of notation used within this publication.

 <b>NOTE:</b>	Highlights an essential element of a procedure to ensure correctness.
 <b>CAUTION!</b>	Indicates a procedure or practice, which, if not strictly observed, could result in damage or destruction of equipment.
 <b>WARNING!</b>	Indicates a procedure or practice, which could result in injury to personnel or loss of life if not followed correctly.

## 1.2 GLOSSARY OF TERMS

Term	Description
DSE7000 MKII, DSE7xxx MKII	All modules in the DSE7xxx MKII range.
DSE7300 MKII, DSE73xx MKII	All modules in the DSE73xx MKII range.
DSE7310 MKII	DSE7310 MKII module/controller
DSE7320 MKII	DSE7320 MKII module/controller
AVR	Automatic Voltage Regulator An electronic device that is contained within a generator and automatically maintains its voltage level to a pre-determined level.
CAN	Controller Area Network Vehicle standard to allow digital devices to communicate to one another.
CDMA	Code Division Multiple Access. Cell phone access used in small number of areas including parts of the USA and Australia.
CT	Current Transformer An electrical device that takes a large AC current and scales it down by a fixed ratio to a smaller current.
BMS	Building Management System A digital/computer-based control system for a building's infrastructure.
DEF	Diesel Exhaust Fluid (AdBlue) A liquid used as a consumable in the SCR process to lower nitric oxide and nitrogen dioxide concentration in engine exhaust emissions.
DM1	Diagnostic Message 1 A DTC that is currently active on the engine ECU.
DM2	Diagnostic Message 2 A DTC that was previously active on the engine ECU and has been stored in the ECU's internal memory.
DPF	Diesel Particulate Filter A filter fitted to the exhaust of an engine to remove diesel particulate matter or soot from the exhaust gas.
DPTC	Diesel Particulate Temperature Controlled Filter A filter fitted to the exhaust of an engine to remove diesel particulate matter or soot from the exhaust gas which is temperature controlled.
DTC	Diagnostic Trouble Code The name for the entire fault code sent by an engine ECU.
ECU/ECM	Engine Control Unit/Management An electronic device that monitors engine parameters and regulates the fuelling.

Continued over page...

<b>Term</b>	<b>Description</b>
FMI	Failure Mode Indicator A part of DTC that indicates the type of failure, e.g. high, low, open circuit etc.
GSM	Global System for Mobile communications. Cell phone technology used in most of the World.
HEST	High Exhaust System Temperature Initiates when DPF filter is full in conjunction with an extra fuel injector in the exhaust system to burn off accumulated diesel particulate matter or soot.
HMI	Human Machine Interface A device that provides a control and visualisation interface between a human and a process or machine.
IDMT	Inverse Definite Minimum Time
MSC	Multi-Set Communication
OC	Occurrence Count A part of DTC that indicates the number of times that failure has occurred.
PGN	Parameter Group Number A CAN address for a set of parameters that relate to the same topic and share the same transmission rate.
PLC	Programmable Logic Controller A programmable digital device used to create logic for a specific purpose.
SCADA	Supervisory Control And Data Acquisition A system that operates with coded signals over communication channels to provide control and monitoring of remote equipment
SCR	Selective Catalytic Reduction A process that uses DEF with the aid of a catalyst to convert nitric oxide and nitrogen dioxide into nitrogen and water to reduce engine exhaust emission.
SIM	Subscriber Identity Module. The small card supplied by the GSM/CDMA provider that is inserted into the cell phone, GSM modem or DSEGateway device to give GSM/GPRS connection.
SMS	Short Message Service The text messaging service of mobile/cell phones.
SPN	Suspect Parameter Number A part of DTC that indicates what the failure is, e.g. oil pressure, coolant temperature, turbo pressure etc.

## 1.3 BIBLIOGRAPHY

This document refers to, and is referred by the following DSE publications which are obtained from the DSE website: [www.deepseaelectronics.com](http://www.deepseaelectronics.com) or by contacting DSE technical support: [support@deepseaelectronics.com](mailto:support@deepseaelectronics.com) .

### 1.3.1 INSTALLATION INSTRUCTIONS

Installation instructions are supplied with the product in the box and are intended as a 'quick start' guide only.

DSE Part	Description
053-032	DSE2548 LED Expansion Annunciator Installation Instructions
053-033	DSE2130 Input Expansion Installation Instructions
053-125	DSE2131 Ratiometric Input Expansion Installation Instructions
053-126	DSE2133 RTD / Thermocouple Input Expansion Installation Instructions
053-134	DSE2152 Analogue Output Expansion Installation Instructions
053-034	DSE2157 Output Expansion Installation Instructions
053-064	DSE2510 and DSE2520 Remote Display Expansion Installation Instructions
053-181	DSE7310 MKII & DSE7320 MKII Installation Instructions
053-147	DSE9460/DSE9461 Enclosed Intelligent Battery Charger Installation Instructions
053-049	DSE9xxx BatteryCharger Installation Instructions

### 1.3.2 TRAINING GUIDES

Training guides are provided as 'hand-out' sheets on specific subjects during training sessions and contain specific information regarding to that subject.

DSE Part	Description
056-005	Using CTs With DSE Products
056-006	Introduction to Comms
056-010	Over Current Protection
056-018	Negative Phase Sequence
056-019	Earth Fault Protection
056-022	Breaker Control
056-023	Adding New CAN Files
056-024	GSM Modem
056-026	kW, kvar, kVA and pf.
056-029	Smoke Limiting
056-030	Module PIN Codes
056-051	Sending DSEGencom Control Keys
056-053	Recommended Modems
056-055	Alternate Configurations
056-069	Firmware Update
056-075	Adding Language Files
056-076	Reading DSEGencom Alarms
056-079	Reading DSEGencom Status
056-080	MODBUS
056-090	DSE73xx MKI to DSE73xx MKII Conversion
056-091	Equipotential Earth Bonding
056-092	Recommended Practices for Wiring Resistive Sensors
056-095	Remote Start Input Functions
056-096	Engine Speed Control Over CAN for DSEGenset
056-097	USB Earth Loops and Isolation
056-098	DSE73xx MKII, DSE74xx MKII & DSE86xx MKII John Deere T4
056-099	Digital Output to Input Connection

### 1.3.3 MANUALS

Product manuals are obtained from the DSE website: [www.deepseaelectronics.com](http://www.deepseaelectronics.com) or by contacting DSE technical support: [support@deepseaelectronics.com](mailto:support@deepseaelectronics.com) .

DSE Part	Description
N/A	DSEGencom (MODBUS protocol for DSE controllers)
057-004	Electronic Engines and DSE Wiring Guide
057-082	DSE2130 Input Expansion Operator Manual
057-139	DSE2131 Ratiometric Input Expansion Operator Manual
057-140	DSE2133 RTD / Thermocouple Input Expansion Operator Manual
057-141	DSE2152 Analogue Output Expansion Operator Manual
057-083	DSE2157 Output Expansion Operator Manual
057-084	DSE2548 Annunciator Expansion Operator Manual
057-278	DSE73xx MKII Conversion to DSE25xx MKII Remote Display Manual
057-279	DSE2510 MKII and DSE2520 MKII Configuration Suite PC Software Manual
057-151	DSE Configuration Suite PC Software Installation & Operation Manual
057-175	PLC Programming Guide For DSE Controllers
057-220	Options for Communications with DSE Controllers
057-243	DSE7310 MKII & DSE7320 MKII Configuration Suite PC Software Manual
057-176	DSE9460/DSE9461 Enclosed Intelligent Battery Charger Operators Manual
057-085	DSE94xx Series Battery Charger Operator Manual

### 1.3.4 THIRD PARTY DOCUMENTS

The following third-party documents are also referred to:

Reference	Description
ISBN 1-55937-879-4	IEEE Std C37.2-1996 IEEE Standard Electrical Power System Device Function Numbers and Contact Designations. Institute of Electrical and Electronics Engineers Inc
ISBN 0-7506-1147-2	Diesel generator handbook. L.L.J. Mahon
ISBN 0-9625949-3-8	On-Site Power Generation. EGSA Education Committee.

## 2 SPECIFICATION

### 2.1 OPERATING TEMPERATURE

Module	Specification
DSE73xx MKII	-30 °C +70 °C (-22 °F +158 °F )
Display Heater Variants	-40 °C +70 °C (-40 °F +158 °F )

#### 2.1.1 OPTIONAL SCREEN HEATER OPERATION

Screen Heater Function	Specification
Turn On When Temperature Falls Below	-10 °C (+14 °F)
Turn Off When Temperature Rises Above	-5 °C (+23 °F)

### 2.2 REQUIREMENTS FOR UL

Description	Specification
Screw Terminal Tightening Torque	4.5 lb-in (0.5 Nm)
Conductors	Terminals suitable for connection of conductor size AWG 20 to AWG 13 (0.5 mm <sup>2</sup> to 2.5 mm <sup>2</sup> ). Conductor protection must be provided in accordance with NFPA 70, Article 240 Low voltage circuits (35 V or less) must be supplied from the engine starting battery or an isolated secondary circuit. The communication, sensor, and/or battery derived circuit conductors shall be separated and secured to maintain at least 1/4" (6 mm) separation from the generator and mains connected circuit conductors unless all conductors are rated 600 V or greater.
Current Inputs	Must be connected through UL Listed or Recognized isolating current transformers with the secondary rating of 5 A max.
Communication Circuits	Must be connected to communication circuits of UL Listed equipment
Output Pilot Duty	0.5 A
Mounting	Suitable for use in type 1 Enclosure Type rating with surrounding air temperature -22 °F to +158 °F (-30 °C to +70 °C) Suitable for pollution degree 3 environments when voltage sensing inputs do not exceed 300 V. When used to monitor voltages over 300 V device to be installed in an unventilated or filtered ventilation enclosure to maintain a pollution degree 2 environment.
Operating Temperature	-22 °F to +158 °F (-30 °C to +70 °C)
Storage Temperature	-40 °F to +176 °F (-40 °C to +80 °C)

## 2.3 TERMINAL SPECIFICATION

Description	Specification	
Connection Type	Two-part connector. Male part fitted to module Female part supplied in module packing case - Screw terminal, rising clamp, no internal spring.	 <p>Example showing cable entry and screw terminals of a 10-way connector</p>
Minimum Cable Size	0.5 mm <sup>2</sup> (AWG 20)	
Maximum Cable Size	2.5 mm <sup>2</sup> (AWG 13)	
Tightening Torque	0.5 Nm (4.5 lb-in)	
Wire Strip Length	7 mm (9/32")	

## 2.4 POWER SUPPLY REQUIREMENTS

Description	Specification
Minimum Supply Voltage	8 V continuous, 5 V for up to 1 minute.
Cranking Dropouts	Able to survive 0 V for 100 ms providing the supply was at least 10 V before the dropout and recovers to 5 V afterwards.
Maximum Supply Voltage	35 V continuous (60 V protection)
Reverse Polarity Protection	-35 V continuous
Maximum Operating Current	340 mA at 12 V 160 mA at 24 V
Maximum Standby Current	160 mA at 12 V 80 mA at 24 V
Maximum Current When In Sleep Mode	100 mA at 12 V 50 mA at 24 V
Typical Power (Controller On, Heater Off)	3.8 W to 4.1 W
Typical Power (Controller On, Heater On)	6.8 W to 7.1 W

### 2.4.1 MODULE SUPPLY INSTRUMENTATION DISPLAY

Description	Specification
Range	0 V to 70 V DC (Maximum continuous operating voltage of 35 V DC)
Resolution	0.1 V
Accuracy	1 % full scale ( $\pm 0.35$ V)

## 2.5 VOLTAGE & FREQUENCY SENSING

Description	Specification
Measurement Type	True RMS conversion
Sample Rate	5 kHz or better
Harmonics	Up to 11th or better
Input Impedance	450 k $\Omega$ phase to phase
Phase To Neutral	15 V (minimum required for sensing frequency) to 415 V AC (absolute maximum) Suitable for 345 V AC nominal ( $\pm 20$ % for under/overvoltage detection)
Phase To Phase	25 V (minimum required for sensing frequency) to 720 V AC (absolute maximum) Suitable for 600 V AC nominal ( $\pm 20$ % for under/overvoltage detection)
Common Mode Offset From Earth	100 V AC (max)
Resolution	1 V AC phase to neutral 1 V AC phase to phase
Accuracy	$\pm 1$ % of full scale phase to neutral $\pm 1$ % of full scale phase to phase
Minimum Frequency	3.5 Hz
Maximum Frequency	75.0 Hz
Frequency Resolution	0.1 Hz
Frequency Accuracy	$\pm 0.2$ Hz

## 2.6 CURRENT SENSING

Description	Specification
Measurement Type	True RMS conversion
Sample Rate	5 kHz or better
Harmonics	Up to 10th or better
Nominal CT Secondary Rating	1 A and 5 A
Maximum Continuous Current	1 A and 5 A
Overload Measurement	15 A
Absolute Maximum Overload	50 A for 1 second
Burden	0.25 VA (0.01 $\Omega$ current shunts)
Common Mode Offset	$\pm 1$ V peak plant ground to CT common terminal
Resolution	25 mA
Accuracy	$\pm 1$ % of Nominal (excluding CT error)

### 2.6.1 VA RATING OF THE CTS

**NOTE:** Details for 4 mm<sup>2</sup> cables are shown for reference only. The connectors on the DSE modules are only suitable for cables up to 2.5 mm<sup>2</sup>.

The VA burden of the module on the CTs is 0.25 VA. However, depending upon the type and length of cabling between the CTs and the module, CTs with a greater VA rating than the module are required.

The distance between the CTs and the measuring module should be estimated and cross-referenced against the chart opposite to find the VA burden of the cable itself.

If the CTs are fitted within the alternator top box, the star point (common) of the CTs should be connected to system ground (earth) as close as possible to the CTs. This minimises the length of cable used to connect the CTs to the DSE module.

**Example:**

If 1.5 mm<sup>2</sup> cable is used and the distance from the CT to the measuring module is 20 m, then the burden of the cable alone is approximately 15 VA. As the burden of the DSE controller is 0.25 VA, then a CT with a rating of at least 15 VA + 0.25 VA = 15.25 VA

must be used. If 2.5 mm<sup>2</sup> cables are used over the same distance of 20 m, then the burden of the cable on the CT is approximately 7 VA. CT's required in this instance is at least 7.25 VA (7 + 0.25).

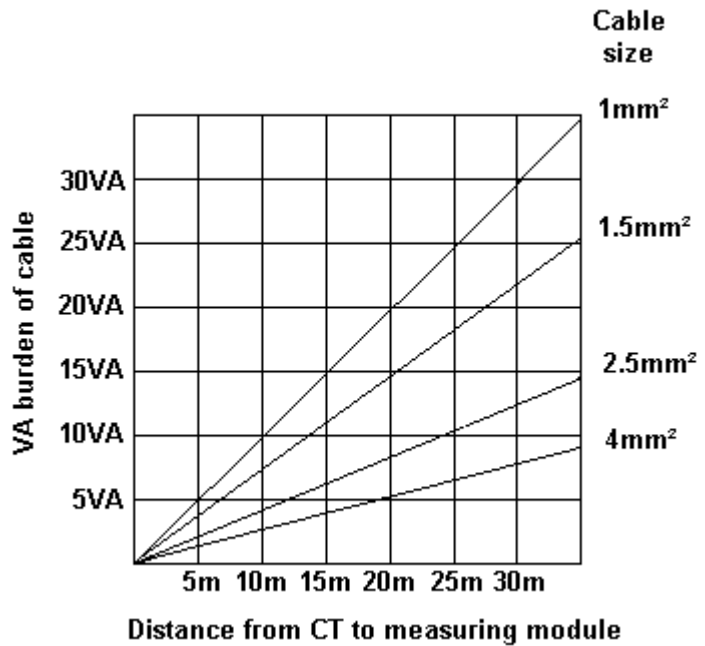



## 2.6.2 CT POLARITY

**NOTE:** Take care to ensure correct polarity of the CT primary as shown above. If in doubt, check with the CT supplier.

Take care to ensure the correct polarity of the CTs. Incorrect CT orientation leads to negative kW readings when the set is supplying power. Take note that paper stick-on labels on CTs that show the orientation are often incorrectly placed on the CT. It is more reliable to use the labelling in the case moulding as an indicator to orientation (if available).

To test orientation, run the generator in island mode (not in parallel with any other supply) and load the generator to around 10 % of the set rating. Ensure the DSE module shows positive kW for all three individual phase readings.

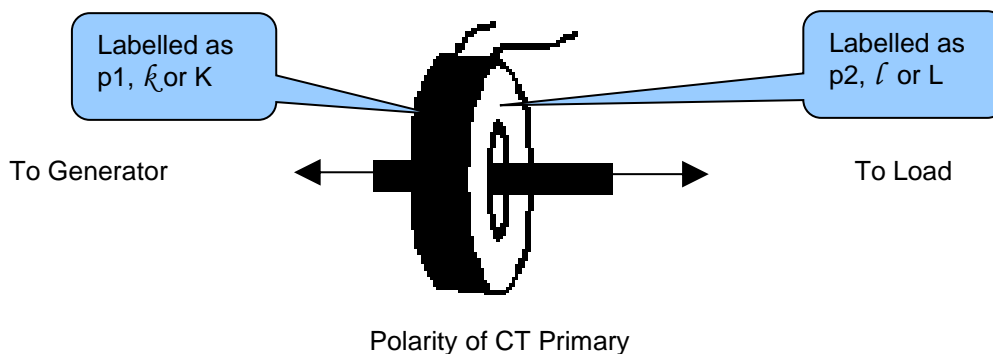

## 2.6.3 CT PHASING

Take particular care that the CTs are connected to the correct phases. For instance, ensure that the CT on phase 1 is connected to the terminal on the DSE module intended for connection to the CT for phase 1.

Additionally, ensure that the voltage sensing for phase 1 is connected to generator phase 1. Incorrect connection of the phases as described above results in incorrect power factor (pf) measurements, which in turn results in incorrect kW measurements.

One way to check for this is to make use of a single-phase load. Place the load on each phase in turn, run the generator and ensure the kW value appears in the correct phase. For instance, if the load is connected to phase 3, ensure the kW figure appears in phase 3 display and not in the display for phase 1 or 2.

## 2.6.4 CT CLASS

Ensure the correct CT type is chosen. For instance, if the DSE module is providing over current protection, ensure the CT can measure the overload level required to protect against, and at the accuracy level required.

For instance, this may mean fitting a protection class CT (P15 type) to maintain high accuracy while the CT is measuring overload currents.

Conversely, if the DSE module is using the CT for instrumentation only (current protection is disabled or not fitted to the controller), then measurement class CTs can be used. Again, bear in mind the accuracy required. The DSE module is accurate to better than 1% of the full-scale current reading. To maintain this accuracy, fit a Class 0.5 or Class 1 CT.

Check with the CT manufacturer for further advice on selecting CTs.

## 2.7 INPUTS

### 2.7.1 DIGITAL INPUTS

Description	Specification
Number	8 configurable digital inputs (14 when <i>Analogue Inputs</i> are configured as digital inputs)
Arrangement	Contact between terminal and ground
Low Level Threshold	2.1 V minimum
High Level Threshold	6.6 V maximum
Maximum Input Voltage	+60 V DC with respect to plant supply negative
Minimum Input Voltage	-24 V DC with respect to plant supply negative
Contact Wetting Current	5 mA typical
Open Circuit Voltage	12 V typical

### 2.7.2 EMERGENCY STOP

Description	Specification
Arrangement	Contact between terminal and module supply positive
Closed Threshold	5 V minimum
Open Threshold	3 V maximum
Maximum Input Voltage	+35 V DC with respect to plant supply negative (60 V protection for 1 minute)
Minimum Input Voltage	-24 V DC with respect to plant supply negative
Open Circuit Voltage	0 V

### 2.7.3 ANALOGUE INPUTS

All the analogue inputs are flexible within the DSE7310 MKII & 7320 MKII modules

#### 2.7.3.1 ANALOGUE INPUT A

Description	Specification
Input Type	Flexible: Configured for <i>Oil Sensor</i> in the DSE default configuration. Flexible Options: Not used, Digital Input, Flexible Analogue, Fuel Sensor, Oil Sensor & Temperature Sensor.
Flexible Input Selection	Pressure Sensor Percentage Sensor Temperature Sensor
Flexible Measured Quantity	Current Resistive (Only for Pressure Sensors) Voltage

#### Resistive Configuration

Description	Specification
Measurement Type	Resistance measurement by measuring voltage across sensor with a fixed current applied
Arrangement	Differential resistance measurement input
Measurement Current	15 mA $\pm 10\%$
Full Scale	240 $\Omega$
Over Range / Fail	350 $\Omega$
Resolution	1 % of full scale
Accuracy	$\pm 2\%$ of full-scale resistance ( $\pm 4.8\ \Omega$ ) excluding sensor error
Max Common Mode Voltage	$\pm 2\text{ V}$
Display Range	Configurable by PC Software

#### 0 V to 10 V Configuration

Description	Specification
Full Scale	0 V to 10 V
Resolution	1% of full scale
Accuracy	$\pm 2\%$ of full-scale voltage ( $\pm 0.2\text{ V}$ ) excluding sensor error
Max Common Mode Voltage	$\pm 2\text{ V}$
Display Range	Configurable by PC Software

#### 4 mA to 20 mA Configuration

Description	Specification
Full Scale	0 mA to 20 mA
Resolution	1% of full scale
Accuracy	$\pm 2\%$ of full-scale current ( $\pm 0.4\text{ mA}$ ) excluding sensor error
Max Common Mode Voltage	$\pm 2\text{ V}$
Display Range	Configurable by PC Software

**2.7.3.2 ANALOGUE INPUT B**

Description	Specification
Input Type	Flexible: Configured for <i>Temperature Sensor</i> in the DSE default configuration Flexible Options: Not used, Digital Input, Flexible Analogue, Fuel Level Sensor & Temperature Sensor
Flexible Input Selection	Pressure Sensor Percentage Sensor Temperature Sensor
Measurement Type	Resistance measurement by measuring voltage across sensor with a fixed current applied
Arrangement	Differential resistance measurement input
Measurement Current	8 mA $\pm$ 10 %
Full Scale	3 k $\Omega$
Over Range / Fail	5 k $\Omega$
Resolution	1 % of full scale
Accuracy	$\pm$ 2 % of full-scale resistance ( $\pm$ 60 $\Omega$ ) excluding sensor error
Max Common Mode Voltage	$\pm$ 2 V
Display Range	Configurable by PC Software

**2.7.3.3 ANALOGUE INPUT C**

Description	Specification
Input Type	Flexible: Configured for <i>Fuel Level Sensor</i> in the DSE default configuration Flexible Options: Not used, Digital Input, Flexible Analogue, Fuel Level Sensor & Temperature Sensor
Flexible Input Selection	Pressure Sensor Percentage Sensor Temperature Sensor
Measurement Type	Resistance measurement by measuring voltage across sensor with a fixed current applied
Arrangement	Differential resistance measurement input
Measurement Current	10 mA $\pm$ 10 %
Full Scale	480 $\Omega$
Over Range / Fail	600 $\Omega$
Resolution	1 % of full scale
Accuracy	$\pm$ 2 % of full-scale resistance ( $\pm$ 9.6 $\Omega$ ) excluding sensor error
Max Common Mode Voltage	$\pm$ 2 V
Display Range	Configurable by PC Software

**2.7.3.4 ANALOGUE INPUT D**

Description	Specification
Input Type	Flexible: Configured for <i>Flexible Sensor</i> in the DSE default configuration Flexible Options: Not used, Digital Input, Flexible Analogue, Fuel Level Sensor & Temperature Sensor
Flexible Input Selection	Pressure Sensor Percentage Sensor Temperature Sensor
Measurement Type	Resistance measurement by measuring voltage across sensor with a fixed current applied
Arrangement	Differential resistance measurement input
Measurement Current	10 mA $\pm$ 10 %
Full Scale	480 $\Omega$
Over Range / Fail	600 $\Omega$
Resolution	1 % of full scale
Accuracy	$\pm$ 2 % of full-scale resistance ( $\pm$ 9.6 $\Omega$ ) excluding sensor error
Max Common Mode Voltage	$\pm$ 2 V
Display Range	Configurable by PC Software

**2.7.3.5 ANALOGUE INPUT E**

Description	Specification
Input Type	Flexible: Configured for <i>Flexible Sensor</i> in the DSE default configuration Flexible Options: Not used, Digital Input, Flexible Analogue, Fuel Level Sensor & Temperature Sensor
Flexible Input Selection	Pressure Sensor Percentage Sensor Temperature Sensor
Measurement Type	Resistance measurement by measuring voltage across sensor with a fixed current applied
Arrangement	Differential resistance measurement input
Measurement Current	8 mA $\pm$ 10 %
Full Scale	3 k $\Omega$
Over Range / Fail	5 k $\Omega$
Resolution	1 % of full scale
Accuracy	$\pm$ 2 % of full-scale resistance ( $\pm$ 60 $\Omega$ ) excluding sensor error
Max Common Mode Voltage	$\pm$ 2 V
Display Range	Configurable by PC Software

## 2.7.3.6 ANALOGUE INPUT F

Description	Specification
Input Type	Flexible: Configured for <i>Flexible Sensor</i> in the DSE default configuration. Flexible Options: Not used, Digital Input, Flexible Analogue, Fuel Sensor & Temperature Sensor.
Flexible Input Selection	Pressure Sensor Percentage Sensor Temperature Sensor
Flexible Measured Quantity	Current Resistive Voltage

**Resistive Configuration**

Description	Specification
Measurement Type	Resistance measurement by measuring voltage across sensor with a fixed current applied
Arrangement	Differential resistance measurement input
Measurement Current	8 mA $\pm$ 10 %
Full Scale	3 k $\Omega$
Over Range / Fail	5 k $\Omega$
Resolution	1 % of full scale
Accuracy	$\pm$ 2 % of full-scale resistance ( $\pm$ 60 $\Omega$ ) excluding transducer error
Max Common Mode Voltage	$\pm$ 2 V
Display Range	Configurable by PC Software

**0 V to 10 V Configuration**

Description	Specification
Full Scale	0 V to 10 V
Resolution	1% of full scale
Accuracy	$\pm$ 2% of full-scale voltage ( $\pm$ 0.2 V) excluding sensor error
Max Common Mode Voltage	$\pm$ 2 V
Display Range	Configurable by PC Software

**4 mA to 20 mA Configuration**

Description	Specification
Full Scale	0 mA to 20 mA
Resolution	1% of full scale
Accuracy	$\pm$ 2% of full-scale current ( $\pm$ 0.4 mA) excluding sensor error
Max Common Mode Voltage	$\pm$ 2 V
Display Range	Configurable by PC Software

### 2.7.4 CHARGE FAIL INPUT

The charge fail input is a combined input and output. Whenever the generator is required to run, the terminal provides excitation current to the charge alternator field winding.

When the charge alternator is correctly charging the battery, the voltage of the terminal is close to the plant battery supply voltage. In a failed charge situation, the voltage of this terminal is pulled down to a low voltage. It is this drop in voltage that triggers the *Charge Failure* alarm. The level at which this operates and whether this triggers a warning or shutdown alarm is configurable using the DSE Configuration Suite Software.

Description	Specification
Minimum Voltage	0 V
Maximum Voltage	35 V
Resolution	0.2 V
Accuracy	±1 % of full scale
Excitation	Active circuit constant power output
Output Power	2.5 W nominal at 12 V and 24 V
Current At 12V	210 mA
Current At 24V	105 mA

### 2.7.5 MAGNETIC PICK-UP

 **NOTE: DSE supply a suitable magnetic pickup device, available in two body thread lengths:**  
**DSE Part number 020-012 - Magnetic Pickup probe 5/8 UNF 2 1/2" thread length**  
**DSE Part number 020-013 - Magnetic Pickup probe 5/8 UNF 4" thread length**

Magnetic Pickup devices can often be 'shared' between two or more devices. For example, one device can often supply the signal to both the DSE module and the engine governor. The possibility of this depends upon the amount of current that the magnetic pickup can supply.

Description	Specification
Type	Differential input
Minimum Voltage	0.5 V Peak
Maximum Voltage	70 V Peak
Max Common Mode Voltage	±2 V Peak
Minimum Frequency	5 Hz
Maximum Frequency	20,000 Hz
Resolution	1 Hz
Accuracy	±1%
Flywheel Teeth	10 to 500

## 2.8 OUTPUTS

### 2.8.1 DC OUTPUTS A & B (FUEL & START)

Description	Specification
Type	Normally used as Fuel & Start outputs. Fully configurable for other purposes if the module is configured to control an electronic engine.
Rating	15 A resistive at plant supply.

### 2.8.2 CONFIGURABLE VOLT-FREE RELAY OUTPUTS C & D

Description	Specification
Type	Normally used for load switching control Fully configurable volt-free relays. Output C normally closed and Output D normal open.
Rating	8 A resistive at 250 V AC

### 2.8.3 CONFIGURABLE DC OUTPUTS E, F, G, H, I & J

Description	Specification
Type	Fully configurable, supplied from DC supply terminal 2.
Rating	2 A resistive at plant supply.



## 2.9 COMMUNICATION PORTS

**▲ NOTE: All communication ports can be used at the same time.**

Description	Specification
USB Slave Port	Type B USB 2.0 For connection to PC running DSE Configuration Suite Max distance 6 m (20 feet)
RS232 Serial Port	Non – isolated Max Baud rate 115 kbaud subject to configuration TX, RX, RTS, CTS, DSR, DTR, DCD Male 9-way D type connector Max distance 15 m (50 feet)
RS485 Serial Port	Isolated Data connection 2 wire + common Half Duplex Data direction control for Transmit (by s/w protocol) Max Baud Rate 115 kbaud subject to configuration Parity subject to configuration Stop Bits subject to configuration External termination required (120 Ω) Max common mode offset 70 V (on board protection transorb) Max distance 1.2 km (¾ mile)
ECU Port	<b>▲ NOTE: For additional length, the DSE124 CAN Extender is available. For more information, refer to DSE Publication: 057-116 DSE124 Operator Manual</b>
	Engine CAN Port Standard implementation of 'Slow mode', up to 250 kb/s Non-Isolated. Internal Termination provided (120 Ω) Max distance 40 m (133 feet)
DSENet® (Expansion Comms) Port	Non-isolated Data connection 2 wire + common Half Duplex Data direction control for Transmit (by s/w protocol) Baud Rate of 115 kbaud Internal termination fitted (120 Ω) Max common mode offset ±5 V Max distance 1.2 km (¾ mile)

## 2.10 COMMUNICATION PORT USAGE

### 2.10.1 USB SLAVE PORT (PC CONFIGURATION)

**NOTE:** DSE stock 2 m (6.5 feet) USB type A to type B cable, DSE Part Number: 016-125. Alternatively, they are purchased from any PC or IT store.

**NOTE:** The DC supply must be connected to the module for configuration by PC.

**NOTE:** For further details of module configuration, refer to DSE Publication: 057-243 *DSE7310 MKII & 7320 MKII Configuration Software Manual*.

The USB port is provided to give a simple means of connection between a PC and the controller. Using the DSE Configuration Suite Software, the operator is then able to control the module, starting or stopping the engine, selecting operating modes, etc.

Additionally, the various operating parameters (such as coolant temperature, oil pressure, etc.) of the engine are available to be viewed or changed.

To connect a module to a PC by USB, the following items are required:

DSE73xx MKII Controller



DSE Configuration Suite PC Software  
(Available from [www.deepseaelectronics.com](http://www.deepseaelectronics.com)).



USB cable Type A to Type B.  
(This is the same cable as often used between a PC and a USB printer)



## 2.10.2 RS232 PORT

**NOTE:** For direct connection, an RS232 null modem (crossover) cable is required. This is rated to a maximum cable length of 15 m.

The RS232 port on the controller supports the MODBUS RTU protocol and is for connection to a single MODBUS master device only.

The MODBUS register table for the controller is available upon request from the DSE Technical Support Department.

RS232 is for short distance communication (max 15m) and is typically used to connect the controller to a telephone or GSM modem for more remote communications.

The various operating parameters (such as coolant temperature, oil pressure, etc.) of the remote engine are viewed or changed.

**NOTE:** For a single module to PC connection and distances up to 6 m (20 feet) the USB connection method is more suitable and provides for a lower cost alternative to RS485 (which is more suited to longer distance connections).

Many PCs are not fitted with an internal RS232 serial port. DSE DOES NOT recommend the use of USB to RS232 converters but can recommend PC add-ons to provide the computer with an RS232 port.

### 2.10.2.1 RECOMMENDED EXTERNAL MODEMS

**NOTE:** For GSM modems a SIM card is required, supplied by the GSM network provider:

For SMS only, a 'normal' voice SIM card is required. This enables the controller to send SMS messages to designated mobile phones upon status and alarm conditions.

For a data connection to a PC running DSE Configuration Suite Software, a 'special' CSD (Circuit Switched Data) SIM card is required that enables the modem to answer an incoming data call. Many 'pay as you go' services do not provide a CSD (Circuit Switched Data) SIM card.

Multitech Global Modem – MultiModem ZBA (PSTN)  
DSE Part Number 020-252  
(Contact DSE Sales for details of localisation kits for these modems)



Sierra Fastrak Xtend GSM modem kit (PSU, Antenna, and modem) \*  
DSE Part number 0830-001-01



### 2.10.2.2 RECOMMENDED PC RS232 SERIAL PORT ADD-ONS

**NOTE:** DSE have no business tie to Brainboxes. Over many years, our own engineers have used these products and are happy to recommend them.

**NOTE:** For further details of setting up the devices below, refer to the manufacture whose details are below.

Remember to check these parts are suitable for your PC. Consult your PC supplier for further advice.

Brainboxes PM143 PCMCIA RS232 card (for laptop PCs)



Brainboxes VX-001 Express Card RS232 (for laptops and nettops PCs)



Brainboxes UC246 PCI RS232 card (for desktop PCs)



Brainboxes PX-246 PCI Express 1 Port RS232 1 x 9 Pin (for desktop PCs)



**Supplier:**  
Brainboxes  
**Tel:** +44 (0)151 220 2500  
**Web:** <http://www.brainboxes.com>  
**Email:** Sales: [sales@brainboxes.com](mailto:sales@brainboxes.com)

### 2.10.2.3 RS232 USED FOR DUAL MUTUAL STANDBY CONNECTION

**NOTE:** For further details of module configuration, refer to DSE Publication: *057-243 DSE7310 MKII & 7320 MKII Configuration Software Manual*.

**NOTE:** To connect two modules by RS232 for *Dual Mutual Standby* operation, a null modem cable must be used.

The dual mutual system utilises the RS232 or RS485 hardware interface to allow multiple modules to communicate to one another. The R232 port can be configured for connection to a modem or remote monitoring equipment (i.e., Building Management System, PLC, or PC RS232 port).

Using the RS232 port for dual mutual communication frees up the RS485 interface for connection to a MODBUS engine or remote monitoring equipment (i.e., Building Management System, PLC, or PC RS485 port).

While this is a very useful feature in some applications, the obvious drawback is that the RS232 port is no longer available connection to a modem or remote monitoring equipment (i.e., Building Management System, PLC, or PC RS232 port).

Example of configuring the dual mutual for connection by RS232 using the DSE Configuration Suite Software:

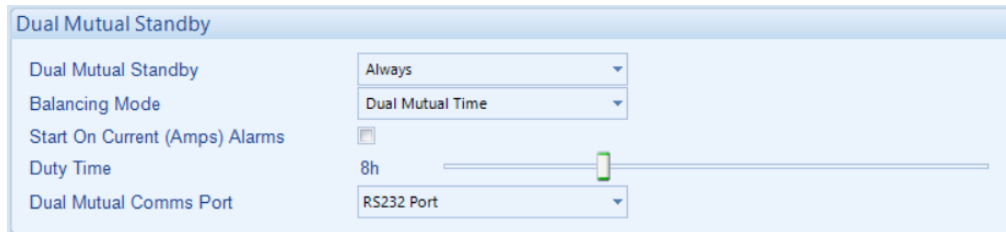

#### 2.10.2.4 RS232 USED FOR THE DSE25XX MKII REMOTE DISPLAY

**NOTE:** For further details of module configuration, refer to DSE Publication: *057-243 DSE7310 MKII & 7320 MKII Configuration Software Manual*.

**NOTE:** DSE25xx MKII Remote Displays utilise the same hardware as DSE73xx MKII modules. Conversion between either module type is possible via a firmware upgrade. For further details refer to DSE Publication: *057-278 DSE73xx MKII Conversion to DSE25xx MKII Remote Display Manual*.

The DSE25xx MKII remote display utilises the RS232 or RS485 hardware interface to allow connection to the DSE73xx MKII genset controller. The R232 port can be configured for connection to a modem or remote monitoring equipment (i.e., Building Management System, PLC, or PC RS232 port).

Using the RS232 port for DSE25xx MKII remote display communications frees up the RS485 interface for connection to a MODBUS engine or remote monitoring equipment (i.e., Building Management System, PLC, or PC RS485 port).

While this is a very useful feature in some applications, the obvious drawback is that the RS232 port is no longer available connection to a modem or remote monitoring equipment (i.e., Building Management System, PLC, or PC RS232 port).

Example of configuring the DSE25xx MKII remote display for connection by RS232 using the DSE Configuration Suite Software:

The screenshot shows a configuration window titled "Remote Display". It is divided into two main sections:

- Display Enable:** This section contains a checkbox labeled "Enable" which is checked. Below it is a dropdown menu for "Link Lost Alarm Action" currently set to "Shutdown".
- Connection Port:** This section contains a dropdown menu for "Port" currently set to "RS232".

### 2.10.3 RS485 PORT

The RS485 port on the controller supports the MODBUS RTU protocol and is for connection to a single MODBUS master device only.

The DSE MODBUS register table for the controller is available upon request from the DSE Technical Support Department.

RS485 is used for point-to-point cable connection of more than one device (maximum 32 devices) and allows for connection to PCs, PLCs, and Building Management Systems (to name just a few devices).

One advantage of the RS485 interface is the large distance specification (1.2 km when using Belden 9841 (or equivalent) cable. This allows for a large distance between the module and a PC running the DSE Configuration Suite software. The operator is then able to control the module, starting or stopping the engine, selecting operating modes, etc.

The various operating parameters (such as coolant temperature, oil pressure, etc.) of the remote engine are viewed or changed.

**NOTE:** For a single module to PC connection and distances up to 6 m (20 feet) the USB connection method is more suitable and provides for a lower cost alternative to RS485 (which is more suited to longer distance connections).

Many PCs are not fitted with an internal RS485 serial port. DSE DOES NOT recommend the use of USB to RS485 converters but can recommend PC add-ons to provide the computer with an RS485port.

#### 2.10.3.1 CABLE SPECIFICATION

**NOTE:** DSE recommend Belden 9841 (or equivalent) cable for RS485 communication. This is rated to a maximum cable length of 1.2 km. DSE Stock Belden 9841 cable, DSE Part Number: 016-030.

Description	Specification
Cable Type	Two core screened and shielded twisted pair
Cable Characteristics	120 Ω impedance Low capacitance
Recommended Cable	Belden 9841 Belden 9271
Maximum Cable Length	1200 m (¾ mile) when using Belden 9841 or direct equivalent. 600 m (656 yards) when using Belden 9271 or direct equivalent.
RS485 Topology	“Daisy Chain” Bus with no stubs (spurs)
RS485 Termination	120 Ω. Not fitted internally to module. Must be fitted externally to the ‘first’ and ‘last’ device on the RS485 link.

### 2.10.3.2 RECOMMENDED PC RS485 SERIAL PORT ADD-ONS

**NOTE:** DSE have no business tie to Brainboxes. Over many years, our own engineers have used these products and are happy to recommend them.

**NOTE:** For further details of setting up the devices below, refer to the manufacture whose details are below.

Remember to check these parts are suitable for your PC. Consult your PC supplier for further advice.

Brainboxes PM154 PCMCIA RS485 card (for laptops PCs)  
Set to 'Half Duplex, Autogating" with 'CTS True' set to 'enabled'



Brainboxes VX-023 ExpressCard 1 Port RS422/485 (for laptops and nettop PCs)



Brainboxes UC320 PCI Velocity RS485 card (for desktop PCs)  
Set to 'Half Duplex, Autogating" with 'CTS True' set to 'enabled'



Brainboxes PX-324 PCI Express 1 Port RS422/485 (for desktop PCs)



Supplier:  
Brainboxes  
Tel: +44 (0)151 220 2500  
Web: <http://www.brainboxes.com>  
Email: Sales: [sales@brainboxes.com](mailto:sales@brainboxes.com)



### 2.10.3.3 RS485 USED FOR MODBUS ENGINE CONNECTION

**NOTE:** For further details of module configuration, refer to DSE Publication: *057-243 DSE7310 MKII & 7320 MKII Configuration Software Manual.*

The RS485 port can be configured for connection to Cummins MODBUS engines (Engines fitted with Cummins GCS (G-Drive Control System)). This leaves the DSENet® interface free for connection to expansion devices.

While this is a very useful feature in some applications, the obvious drawback is that the RS485 interface is no longer available connection or remote monitoring equipment (i.e., Building Management System, PLC, or PC RS232 port) or dual mutual system.

Example of configuring the DSENet® for connection to Cummins QSK GCS using the DSE Configuration Suite Software:

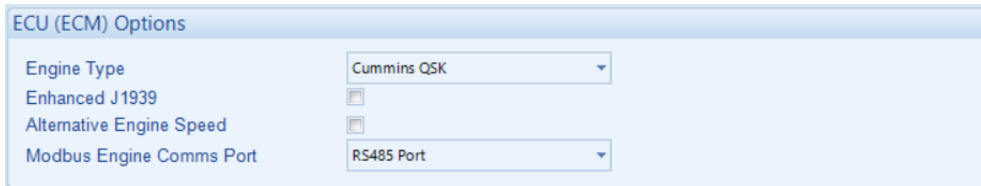

### 2.10.3.4 RS485 USED FOR DUAL MUTUAL STANDBY CONNECTION

**NOTE:** For further details of module configuration, refer to DSE Publication: *057-243 DSE7310 MKII & 7320 MKII Configuration Software Manual.*

The dual mutual system utilises the RS232 or RS485 hardware interface to allow multiple modules to communicate to one another. The R485 port can be configured for connection to a MODBUS engine or remote monitoring equipment (i.e., Building Management System, PLC, or PC RS485 port).

Using the RS485 port for dual mutual communication frees up the RS232 interface for connection to a Modem or remote monitoring equipment (i.e., Building Management System, PLC, or PC RS232 port).

While this is a very useful feature in some applications, the obvious drawback is that the RS485 port is no longer available connection to a MODBUS ECU or remote monitoring equipment (i.e., Building Management System, PLC, or PC RS485 port).

Example of configuring the dual mutual for connection by RS485 using the DSE Configuration Suite Software:



### 2.10.3.5 RS485 USED FOR THE DSE25XX MKII REMOTE DISPLAY

**NOTE:** For further details of module configuration, refer to DSE Publication: *057-243 DSE7310 MKII & 7320 MKII Configuration Software Manual*.

**NOTE:** DSE25xx MKII Remote Display units utilise the same hardware as DSE73xx MKII modules. Conversion between either module type is possible via a firmware upgrade. For further details refer to DSE Publication: *057-278 DSE73xx MKII Conversion to DSE25xx MKII Remote Display Manual*.

The DSE25xx MKII remote display utilises the RS232 or RS485 hardware interface to allow connection to the DSE73xx MKII genset controller. The R485 port can be configured for connection to a MODBUS engine or remote monitoring equipment (i.e., Building Management System, PLC, or PC RS485 port).

Using the RS485 port for DSE25xx MKII remote display communications frees up the RS232 interface for connection to a Modem or remote monitoring equipment (i.e., Building Management System, PLC, or PC RS232 port).

While this is a very useful feature in some applications, the obvious drawback is that the RS485 port is no longer available connection to a MODBUS ECU or remote monitoring equipment (i.e., Building Management System, PLC, or PC RS485 port).

Example of configuring the DSE25xx MKII remote display for connection by RS485 using the DSE Configuration Suite Software:

Remote Display	
Display Enable	
Enable	<input checked="" type="checkbox"/>
Link Lost Alarm Action	Shutdown
Connection Port	
Port	RS485

#### 2.10.4 ECU PORT (J1939)

**NOTE:** Screened 120  $\Omega$  impedance cable specified for use with CAN must be used for the CAN link. DSE stock and supply Belden cable 9841 which is a high quality 120  $\Omega$  impedance cable suitable for CAN use (DSE part number 016-030)

The *ECU Port* is used for connection of more than one device and allows for connection to engine ECU/ECMs, alternator AVRs, CAN Scanner, PLC, and CAN controllers (to name just a few devices). The operator is then able to view the various operating parameters.

##### 2.10.4.1 CAN SUPPORTED ENGINES

**NOTE:** For further details on connection to electronic engines, refer to DSE Publication: *057-004 Electronic Engines And DSE Wiring*

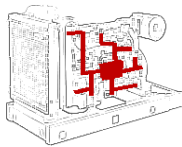

The modules are fitted with a CAN interface as standard and can receive engine data from engine ECU/ECMs compliant with the CAN J1939 standard.

ECU/ECMs monitor the engine's operating parameters such as speed, oil pressure, coolant temperature (among others) to closely monitor and control the engine. The industry standard communications interface (CAN) transports data gathered by the engine's ECU/ECM using the J1939 protocol. This allows engine controllers such as DSE to access these engine parameters with no physical connection to the sensor device.

##### 2.10.4.2 CAN SUPPORTED AVRS

**NOTE:** For further details on connection to supported CANbus AVRs, contact DSE technical support: [support@deepseaelectronics.com](mailto:support@deepseaelectronics.com).

The modules are fitted with a CAN interface as standard and can receive alternator data from certain AVRs compliant with the CAN J1939 standard.

AVRs are used to maintain the alternators' output voltage by controlling the excitation current in addition to closely monitoring and protecting the alternator. The industry standard communications interface (CAN) transports data gathered by the alternators' AVR using the J1939 protocol. This allows generator controllers such as DSE to access these alternator parameters with no physical connection to the sensor device.

2.10.4.3 J1939-75

**NOTE:** For further details of module configuration, refer to DSE Publication: *057-243 DSE7310 MKII & 7320 MKII Configuration Software Manual*.

**NOTE:** For further details of CAN communication, see section 11 entitled *CAN Interface Specification (J1939-75)* in this document.

When the J1939-75 is enabled in the module's configuration, the module's AC measurements and alarms are sent onto the CANbus using the *ECU Port* to be received by an external monitoring device. There are two check boxes to enable each of the two parts of the interface as shown below, AC measurement and AC related alarms. The module AC alarms are translated into J1939 DM1 diagnostic messages. There are no additional display screens visible on the module when these options are selected. The default CAN source address for additional J1939-75 messages is 44 however this may be changed by the generator supplier.

Miscellaneous Options

J1939-75 Instrumentation Enable	<input checked="" type="checkbox"/>
J1939-75 Alarms Enable	<input checked="" type="checkbox"/>
CAN source address (instrumentation)	44

2.10.4.4 CONFIGURABLE CAN

 **NOTE: For further details of module configuration, refer to DSE Publication: 057-243 DSE7310 MKII & 7320 MKII Configuration Software Manual.**

The module's CAN port is used to connect third-party CAN devices (controllers, battery chargers...) and allows the module to read and transmit configurable CAN instruments.

The DSE module supports connection to a CAN device and can read up to 30 parameters and transmit up to 10 parameters; these parameters are configurable, and the read instrumentation is displayable on the module LCD and/or in SCADA.

**Received Instrumentation**

**Instrumentation Configuration**

Enabled	Module	Message ID		Timeout		Data Structure				Display		Bus Value		Mapped Value		Fn
		Description	Bits	CAN ID	Enable	(ms)	Byte	Bit	Length	Signed	D. Places	Suffix	Smallest	Largest	Smallest	
<input checked="" type="checkbox"/>	CAN	Configurable CAN 1	29	0x8	<input checked="" type="checkbox"/>	5000	1	6	7	<input type="checkbox"/>	0	0	9	0	128	Fn
<input checked="" type="checkbox"/>	CAN	Configurable CAN 2	29	0x7	<input checked="" type="checkbox"/>	5000	1	6	5	<input type="checkbox"/>	0	0	3	0	100	Fn
<input checked="" type="checkbox"/>	CAN	Configurable CAN 3	29	0x7	<input checked="" type="checkbox"/>	5000	1	0	15	<input type="checkbox"/>	0	0	20	0	100	Fn
<input checked="" type="checkbox"/>	CAN	Configurable CAN 4	29	0x8	<input checked="" type="checkbox"/>	5000	1	0	5	<input checked="" type="checkbox"/>	0	-13	-12	0	108	Fn
<input type="checkbox"/>	CAN	Configurable CAN 5	29	0x0	<input checked="" type="checkbox"/>	5000	1	0	1	<input type="checkbox"/>	0	0	1	0	100	Fn
<input type="checkbox"/>	CAN	Configurable CAN 6	29	0x0	<input checked="" type="checkbox"/>	5000	1	0	1	<input type="checkbox"/>	0	0	1	0	100	Fn
<input type="checkbox"/>	CAN	Configurable CAN 7	29	0x0	<input checked="" type="checkbox"/>	5000	1	0	1	<input type="checkbox"/>	0	0	1	0	100	Fn
<input type="checkbox"/>	CAN	Configurable CAN 8	29	0x0	<input checked="" type="checkbox"/>	5000	1	0	1	<input type="checkbox"/>	0	0	1	0	100	Fn
<input type="checkbox"/>	CAN	Configurable CAN 9	29	0x0	<input checked="" type="checkbox"/>	5000	1	0	1	<input type="checkbox"/>	0	0	1	0	100	Fn
<input type="checkbox"/>	CAN	Configurable CAN 10	29	0x0	<input checked="" type="checkbox"/>	5000	1	0	1	<input type="checkbox"/>	0	0	1	0	100	Fn
<input type="checkbox"/>	CAN	Configurable CAN 11	29	0x0	<input checked="" type="checkbox"/>	5000	1	0	1	<input type="checkbox"/>	0	0	1	0	100	Fn
<input type="checkbox"/>	CAN	Configurable CAN 12	29	0x0	<input checked="" type="checkbox"/>	5000	1	0	1	<input type="checkbox"/>	0	0	1	0	100	Fn
<input type="checkbox"/>	CAN	Configurable CAN 13	29	0x0	<input checked="" type="checkbox"/>	5000	1	0	1	<input type="checkbox"/>	0	0	1	0	100	Fn
<input type="checkbox"/>	CAN	Configurable CAN 14	29	0x0	<input checked="" type="checkbox"/>	5000	1	0	1	<input type="checkbox"/>	0	0	1	0	100	Fn
<input type="checkbox"/>	CAN	Configurable CAN 15	29	0x0	<input checked="" type="checkbox"/>	5000	1	0	1	<input type="checkbox"/>	0	0	1	0	100	Fn
<input type="checkbox"/>	CAN	Configurable CAN 16	29	0x0	<input checked="" type="checkbox"/>	5000	1	0	1	<input type="checkbox"/>	0	0	1	0	100	Fn
<input type="checkbox"/>	CAN	Configurable CAN 17	29	0x0	<input checked="" type="checkbox"/>	5000	1	0	1	<input type="checkbox"/>	0	0	1	0	100	Fn
<input type="checkbox"/>	CAN	Configurable CAN 18	29	0x0	<input checked="" type="checkbox"/>	5000	1	0	1	<input type="checkbox"/>	0	0	1	0	100	Fn
<input type="checkbox"/>	CAN	Configurable CAN 19	29	0x0	<input checked="" type="checkbox"/>	5000	1	0	1	<input type="checkbox"/>	0	0	1	0	100	Fn

**Test**

Test Value

Output Value 0

### 2.10.5 DSENET® (EXPANSION MODULES)

**NOTE:** For further details of module configuration, refer to DSE Publication: *057-243 DSE7310 MKII & 7320 MKII Configuration Software Manual*.

**NOTE:** As a termination resistor is internally fitted to the controller, the controller must be the 'first' unit on the DSENet® link. A termination resistor **MUST** be fitted to the 'last' unit on the DSENet® link. For connection details, refer to section 3.3 entitled *Typical Wiring Diagram* in this document.

**NOTE:** DSE recommend Belden 9841 (or equivalent) cable for DSENet® communication. This is rated to a maximum cable length of 1.2 km. DSE Stock Belden 9841 cable, DSE Part Number: 016-030.

DSENet® is the interconnection cable between the host controller and the expansion module(s) and must not be connected to any device other than DSE equipment designed for connection to the DSENet®

Description	Specification
Cable Type	Two core screened and shielded twisted pair
Cable Characteristics	120 Ω Low capacitance
Recommended Cable	Belden 9841 Belden 9271
Maximum Cable Length	1200 m (¾ mile) when using Belden 9841 or direct equivalent. 600 m (656 yards) when using Belden 9271 or direct equivalent.
DSENet® Topology	"Daisy Chain" Bus with no stubs (spurs)
DSENet® Termination	120 Ω. Fitted internally to host controller. Must be fitted externally to the 'last' expansion module.
Maximum Expansion Modules	<p><b>NOTE:</b> Only supported DSE Intelligent Battery Chargers may be connected to the DSENet®. Contact DSE Technical Support for further information.</p>
	<p><b>NOTE:</b> When connecting a DSE25xx MKII Remote Display on DSENet, the maximum number of supported expansion modules reduces from 20 down to 5 (including only 1 battery charger).</p>
	<p>Total 20 devices made up of DSE2130 (up to 4), DSE2131 (up to 4), DSE2133 (up to 4), DSE2152 (up to 4), DSE2157 (up to 10), DSE2510 or DSE2520 (up to 3), DSE2548 (up to 10), DSE25xx MKII (upto 1) and DSE Intelligent Battery Chargers (up to 4).</p> <p>This gives the possibility of:                      Maximum 32 additional 0 V to 10 V or 4 mA to 20 mA outputs (DSE2152)                      Maximum 80 additional relay outputs (DSE2157)                      Maximum 80 additional LED indicators                      Maximum 24 additional RTD or thermocouple inputs (DSE2133).                      Maximum 32 additional inputs (Can be configured as either digital, or resistive when using DSE2130)                      Maximum 40 additional flexible inputs (All can be configured as either digital, resistive, 0 V to 10 V or 4 mA to 20 mA when using DSE2131)                      Maximum 1 DSE25xx MKII Remote Display.</p>

	Maximum 4 DSE Intelligent Battery Chargers.
--	---

**2.10.5.1 DSENET® USED FOR MODBUS ENGINE CONNECTION**

**▲ NOTE: For further details of module configuration, refer to DSE Publication: 057-243 DSE7310 MKII & 7320 MKII Configuration Software Manual.**

As DSENet® utilises an RS485 hardware interface, this port can be configured for connection to Cummins MODBUS engines (Engines fitted with Cummins GCS (G-Drive Control System)). This leaves the RS485 interface free for connection to remote monitoring equipment (i.e., Building Management System, PLC, or PC RS485 port).

While this is a very useful feature in some applications, the obvious drawback is that the DSENet® interface is no longer available for connection to expansion devices.

Example of configuring the DSENet® for connection to Cummins QSK GCS using the DSE Configuration Suite Software:

The screenshot shows a configuration window titled "ECU (ECM) Options". It contains the following settings:

Engine Type	Cummins QSK
Enhanced J1939	<input type="checkbox"/>
Alternative Engine Speed	<input type="checkbox"/>
Modbus Engine Comms Port	DSENet Port

## 2.11 SOUNDER

The module features an internal sounder to draw attention to warning, electrical trip, and shutdown alarms.

Description	Specification
Sounder Level	64 db at 1 m

### 2.11.1 ADDING AN EXTERNAL SOUNDER

Should an external alarm or indicator be required, this can be achieved by using the DSE Configuration Suite PC software to configure an auxiliary output for *Audible Alarm*, and by configuring an auxiliary input for *Alarm Mute* (if required).

The audible alarm output activates and de-activates at the same time as the module's internal sounder. The Alarm mute input and internal **Lamp Test / Alarm Mute**  button activate 'in parallel' with each other. Either signal mutes both the internal sounder and audible alarm output.

Example of configuration to achieve external sounder with external alarm mute button:

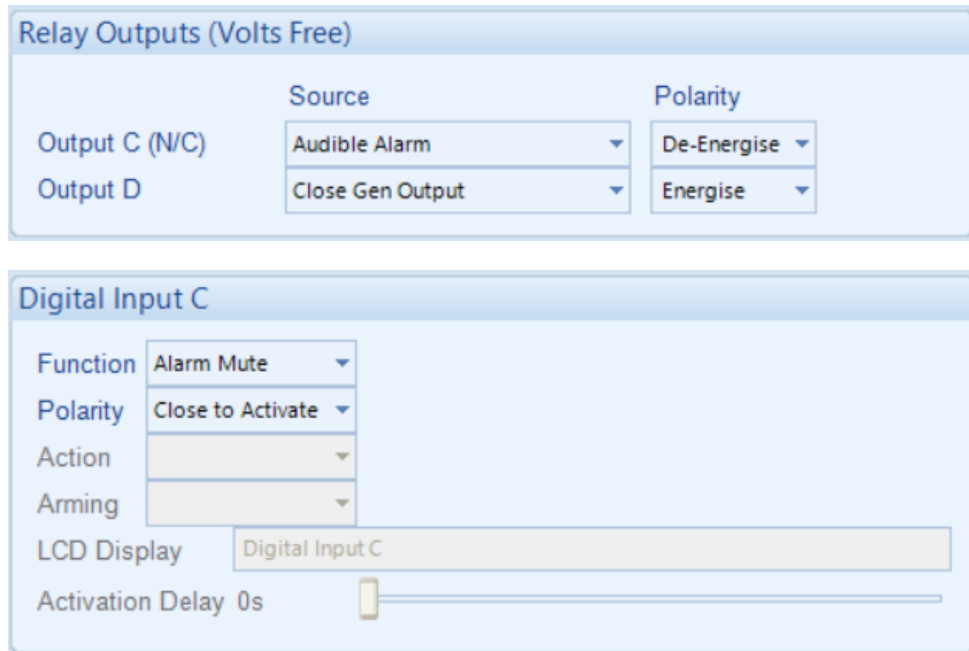

The screenshot displays two configuration windows from the DSE Configuration Suite software. The top window, titled "Relay Outputs (Volts Free)", shows two outputs: Output C (N/C) is configured with Source "Audible Alarm" and Polarity "De-Energise"; Output D is configured with Source "Close Gen Output" and Polarity "Energise". The bottom window, titled "Digital Input C", shows the Function set to "Alarm Mute", Polarity set to "Close to Activate", and an "Activation Delay" slider set to 0s. The LCD Display shows "Digital Input C".



## 2.12 ACCUMULATED INSTRUMENTATION

**▲ NOTE: When an accumulated instrumentation value exceeds the maximum number as listed below, the value is reset and begins counting from zero again.**

The number of logged *Engine Hours* and *Number of Starts* can be set/reset using the DSE Configuration Suite PC software. Depending upon module configuration, this may have been PIN number locked by the generator supplier.

Description	Specification
Engine Hours Run	Maximum 99999 hrs 59 minutes (Approximately 11yrs 4 months)
Number of Starts	1,000,000 (1 Million)
Accumulated Power	999999 kWh / kvarh / kVAh

## 2.13 DIMENSIONS AND MOUNTING

### 2.13.1 DIMENSIONS

245 mm x 184 mm x 51 mm  
(9.6" x 7.2" x 2.0")

### 2.13.2 PANEL CUTOUT

220 mm x 160 mm  
(8.7" x 6.3")

### 2.13.3 WEIGHT

0.98 kg  
(2.16 lb)

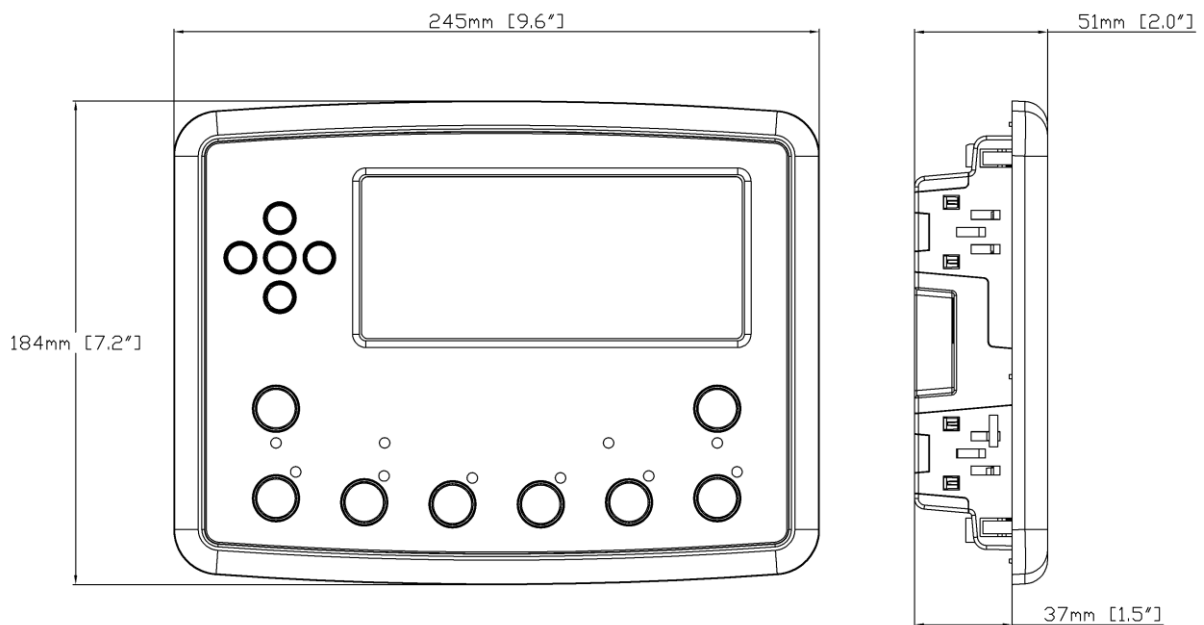

### 2.13.4 FIXING CLIPS

**NOTE:** In conditions of excessive vibration, mount the module on suitable anti-vibration mountings.

The module is held into the panel fascia using the supplied fixing clips.

Withdraw the fixing clip screw (turn anticlockwise) until only the pointed end is protruding from the clip.

Insert the three 'prongs' of the fixing clip into the slots in the side of the module case.

Pull the fixing clip backwards (towards the back of the module) ensuring all three prongs of the clip are inside their allotted slots.

Turn the fixing clip screws clockwise until they contact the panel fascia.

Turn the screw a quarter of a turn to secure the module into the panel fascia. Care must be taken not to over tighten the fixing clip screws.

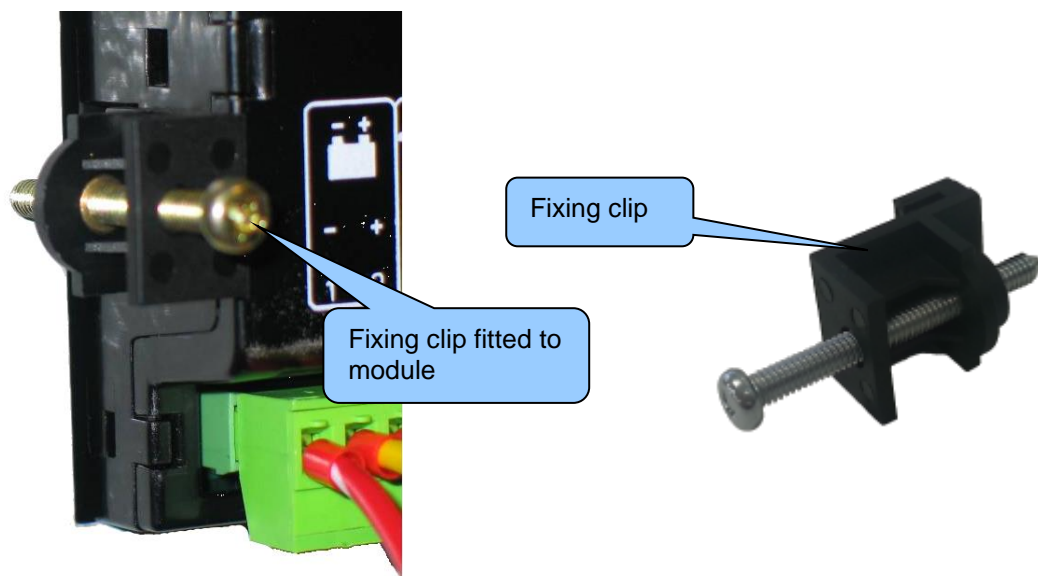

### 2.13.5 CABLE TIE FIXING POINTS

Cable tie fixing points are included on the rear of the module's case to aid wiring. This additionally provides strain relief to the cable loom by removing the weight of the loom from the screw connectors, reducing the chance of future connection failures.

Care must be taken not to over tighten the cable tie (for instance with cable tie tools) to prevent the risk of damage to the module case.



Cable Tie Fixing Point



With Cable And Tie In Place

### 2.13.6 SILICON SEALING GASKET

**NOTE:** For purchasing a silicon gasket from DSE, see section 12 entitled Maintenance, Spares, Repair and Servicing in this document.

The silicon gasket provides improved sealing between module and the panel fascia. The gasket is fitted to the module before installation into the panel fascia. Take care to ensure the gasket is correctly fitted to the module to maintain the integrity of the seal.



## 2.14 APPLICABLE STANDARDS

Standard	Description
BS 4884-1	This document conforms to BS4884-1 1992 Specification for presentation of essential information.
BS 4884-2	This document conforms to BS4884-2 1993 Guide to content
BS 4884-3	This document conforms to BS4884-3 1993 Guide to presentation
BS EN 60068-2-1 (Minimum temperature)	-30 °C (-22 °F)
BS EN 60068-2-2 (Maximum temperature)	+70 °C (158 °F)
BS EN 60068-2-6 (Vibration)	Ten sweeps in each of three major axes 5 Hz to 8 Hz at ±7.5 mm 8 Hz to 500 Hz at 2 gn
BS EN 60068-2-27 (Shock)	Three shocks in each of three major axes 15 gn in 11 ms
BS EN 60068-2-30 (Damp heat cyclic)	20°C to 55 °C at 95% relative humidity for 48 hours
BS EN 60068-2-78 (Damp heat static)	40 °C at 95% relative humidity for 48 hours
BS EN 60950 (Electrical safety)	Safety of information technology equipment, including electrical business equipment
BS EN 61000-6-2 (Electro-magnetic Compatibility)	EMC Generic Immunity Standard (Industrial)
BS EN 61000-6-4 (Electro-magnetic Compatibility)	EMC Generic Emission Standard (Industrial)
BS EN 60529 (Degrees of protection provided by enclosures)	IP65 (front of module when installed into the control panel with the optional sealing gasket) IP42 (front of module when installed into the control panel WITHOUT being sealed to the panel)
UL508 NEMA rating (Approximate)	12 (Front of module when installed into the control panel with the optional sealing gasket). 2 (Front of module when installed into the control panel WITHOUT being sealed to the panel)
IEEE C37.2 (Standard Electrical Power System Device Function Numbers and Contact Designations)	Under the scope of IEEE 37.2, function numbers can also be used to represent functions in microprocessor devices and software programs. The controller is device number 11L-8000 (Multifunction device protecting Line (generator) –module).  As the module is configurable by the generator OEM, the functions covered by the module vary. Depending on module configuration, the device numbers included within the module could be:  2 – Time Delay Starting Or Closing Relay 3 – Checking Or Interlocking Relay 5 – Stopping Device 6 – Starting Circuit Breaker 8 – Control Power Disconnecting Device 10 – Unit Sequence Switch 11 – Multifunction Device 12 – Overspeed Device 14 – Underspeed Device

Continued over the page...

Standard	Description
IEEE C37.2 (Standard Electrical Power System Device Function Numbers and Contact Designations)	Continued... 49 – Machine or Transformer Thermal Relay 50 – Instantaneous Overcurrent Relay 51 – AC Time Overcurrent Relay 52 – AC Circuit Breaker 53 – Exciter Or DC Generator Relay 54 – Turning Gear Engaging Device 55 – Power Factor Relay ( <b>USING INTERNAL PLC EDITOR</b> ) 59AC – AC Overvoltage Relay 59DC – DC Overvoltage Relay 62 – Time Delay Stopping Or Opening Relay 63 – Pressure Switch 71 – Level Switch 74 – Alarm Relay 78 – Phase-Angle Measuring Relay 79 – Reclosing Relay ( <b>USING INTERNAL PLC EDITOR</b> ) 81 – Frequency Relay 83 – Automatic Selective Control Or Transfer Relay 86 – Lockout Relay

In line with our policy of continual development, Deep Sea Electronics, reserve the right to change specification without notice.

## 2.14.1 ENCLOSURE CLASSIFICATIONS

### 2.14.1.1 IP CLASSIFICATIONS

The modules specification under BS EN 60529 Degrees of protection provided by enclosures

**IP65** (Front of module when module is installed into the control panel with the optional sealing gasket).

**IP42** (front of module when module is installed into the control panel WITHOUT being sealed to the panel)

First Digit	Second Digit
Protection against contact and ingress of solid objects	Protection against ingress of water
0 No protection	0 No protection
1 Protected against ingress solid objects with a diameter of more than 50 mm. No protection against deliberate access, e.g. with a hand, but large surfaces of the body are prevented from approach.	1 Protection against dripping water falling vertically. No harmful effect must be produced (vertically falling drops).
2 Protected against penetration by solid objects with a diameter of more than 12 mm. Fingers or similar objects prevented from approach.	2 Protection against dripping water falling vertically. There must be no harmful effect when the equipment (enclosure) is tilted at an angle up to 15° from its normal position (drops falling at an angle).
3 Protected against ingress of solid objects with a diameter of more than 2.5 mm. Tools, wires etc. with a thickness of more than 2.5 mm are prevented from approach.	3 Protection against water falling at any angle up to 60° from the vertical. There must be no harmful effect (spray water).
4 Protected against ingress of solid objects with a diameter of more than 1 mm. Tools, wires etc. with a thickness of more than 1 mm are prevented from approach.	4 Protection against water splashed against the equipment (enclosure) from any direction. There must be no harmful effect (splashing water).
5 Protected against harmful dust deposits. Ingress of dust is not totally prevented but the dust must not enter in sufficient quantity to interface with satisfactory operation of the equipment. Complete protection against contact.	5 Protection against water projected from a nozzle against the equipment (enclosure) from any direction. There must be no harmful effect (water jet).
6 Protection against ingress of dust (dust tight). Complete protection against contact.	6 Protection against heavy seas or powerful water jets. Water must not enter the equipment (enclosure) in harmful quantities (splashing over).

2.14.1.2 NEMA CLASSIFICATIONS

 **NOTE: There is no direct equivalence between IP / NEMA ratings. IP figures shown are approximate only.**

**12** (Front of module when module is installed into the control panel with the optional sealing gasket).  
**2** (Front of module when module is installed into the control panel WITHOUT being sealed to the panel)

1 <b>IP30</b>	Provides a degree of protection against contact with the enclosure equipment and against a limited amount of falling dirt.
2 <b>IP31</b>	Provides a degree of protection against limited amounts of falling water and dirt.
3 <b>IP64</b>	Provides a degree of protection against windblown dust, rain, and sleet; undamaged by the formation of ice on the enclosure.
3R <b>IP32</b>	Provides a degree of protection against rain and sleet;; undamaged by the formation of ice on the enclosure.
4 (X) <b>IP66</b>	Provides a degree of protection against splashing water, windblown dust and rain, hose directed water; undamaged by the formation of ice on the enclosure. (Resist corrosion).
12/12K <b>IP65</b>	Provides a degree of protection against dust, falling dirt and dripping non corrosive liquids.
13 <b>IP65</b>	Provides a degree of protection against dust and spraying of water, oil and non corrosive coolants.

### 3 INSTALLATION

The module is designed to be mounted on the panel fascia. For dimension and mounting details, see section 2.13 entitled *Dimension and Mounting* in this document.

#### 3.1 USER CONNECTIONS

**NOTE:** Availability of some terminals depends upon module version. Full details are given in section 3.2 entitled *Connection Descriptions* in this manual.

To aid user connection, icons are used on the rear of the module to help identify terminal functions. An example of this is shown below.

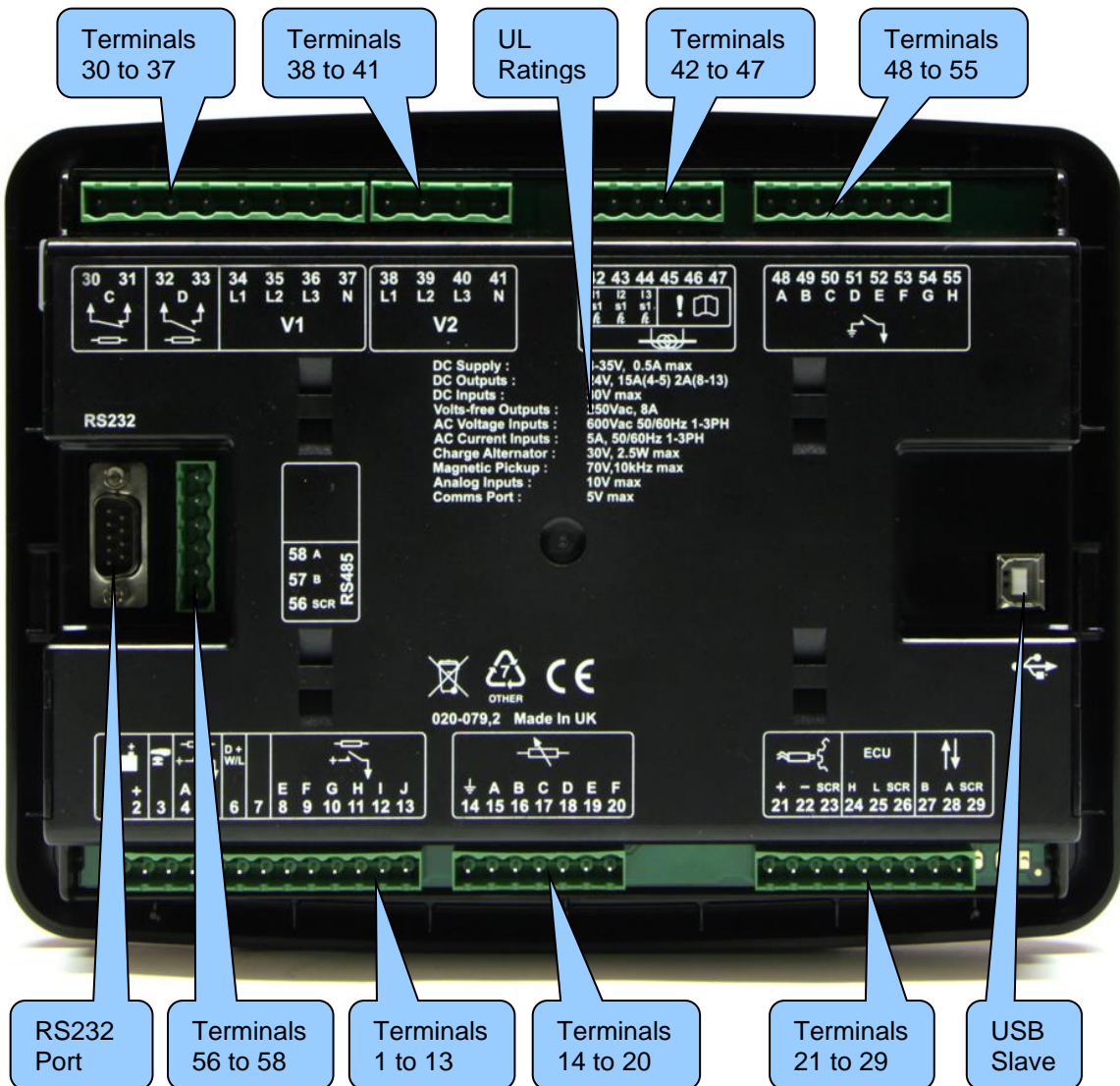







### 3.2 CONNECTION DESCRIPTIONS

#### 3.2.1 DC SUPPLY, E-STOP INPUT, DC OUTPUTS & CHARGE FAIL INPUT

 **NOTE:** When the module is configured for operation with an electronic engine, *Fuel* and *Start* output requirements may be different. For further details on connection to electronic engines, refer to DSE Publication: *057-004 Electronic Engines And DSE Wiring*

 **NOTE:** For further details of module configuration, refer to DSE Publication: *057-243 DSE7310 MKII & 7320 MKII Configuration Software Manual.*

	Pin No	Description	Cable Size	Notes
	1	DC Plant Supply Input (Negative)	2.5 mm <sup>2</sup> AWG 13	Connect to ground where applicable.
	2	DC Plant Supply Input (Positive)	2.5 mm <sup>2</sup> AWG 13	Supplies the module and DC Outputs E, F, G, H, I & J
	3	Emergency Stop Input	2.5 mm <sup>2</sup> AWG 13	Plant Supply Positive. Supplies DC Outputs A & B.
	4	DC Output A (FUEL)	2.5 mm <sup>2</sup> AWG 13	Plant Supply Positive from terminal 3. 15 A DC rated Fixed as fuel relay if electronic engine is not configured.
	5	DC Output B (START)	2.5 mm <sup>2</sup> AWG 13	Plant Supply Positive from terminal 3. 15 A DC rated Fixed as start relay if electronic engine is not configured.
<b>D+ W/L</b>	6	Charge Fail / Excite	2.5 mm <sup>2</sup> AWG 13	Do not connect to ground (battery negative). If charge alternator is not fitted, leave this terminal disconnected.
	7	DO NOT CONNECT		
	8	DC Output E	1.0 mm <sup>2</sup> AWG 18	Plant Supply Positive from terminal 2. 2 A DC rated.
	9	DC Output F	1.0 mm <sup>2</sup> AWG 18	Plant Supply Positive from terminal 2. 2 A DC rated.
	10	DC Output G	1.0 mm <sup>2</sup> AWG 18	Plant Supply Positive from terminal 2. 2 A DC rated.
	11	DC Output H	1.0 mm <sup>2</sup> AWG 18	Plant Supply Positive from terminal 2. 2 A DC rated.
	12	DC Output I	1.0 mm <sup>2</sup> AWG 18	Plant Supply Positive from terminal 2. 2 A DC rated.
	13	DC Output J	1.0 mm <sup>2</sup> AWG 18	Plant Supply Positive from terminal 2. 2 A DC rated.

### 3.2.2 ANALOGUE SENSOR INPUTS

**NOTE:** For further details of module configuration, refer to DSE Publication: *057-243 DSE7310 MKII & 7320 MKII Configuration Software Manual.*

**NOTE:** It is VERY important that terminal 14 (sensor common) is connected to an earth point on the ENGINE BLOCK, not within the control panel, and must be a sound electrical connection to the sensor bodies. This connection MUST NOT be used to provide an earth connection for other terminals or devices. The simplest way to achieve this is to run a SEPARATE earth connection from the system earth star point, to terminal 14 directly, and not use this earth for other connections.

**NOTE:** If PTFE insulating tape is used on the sensor thread when using earth return sensors, ensure not to insulate the entire thread, as this prevents the sensor body from being earthed via the engine block.

Pin No	Description	Cable Size	Notes
14	Sensor Common Return	0.5 mm <sup>2</sup> AWG 20	Ground Return Feed For Sensors
15	Analogue Sensor Input A	0.5 mm <sup>2</sup> AWG 20	Connect To Oil Pressure Sensor
16	Analogue Sensor Input B	0.5mm <sup>2</sup> AWG 20	Connect To Coolant Temperature Sensor
17	Analogue Sensor Input C	0.5 mm <sup>2</sup> AWG 20	Connect To Fuel Level Sensor
18	Analogue Sensor Input D	0.5 mm <sup>2</sup> AWG 20	Connect To Additional Sensor (User Configurable)
19	Analogue Sensor Input E	0.5 mm <sup>2</sup> AWG 20	Connect To Additional Sensor (User Configurable)
20	Analogue Sensor Input F	0.5 mm <sup>2</sup> AWG 20	Connect To Additional Sensor (User Configurable)



### 3.2.3 MPU, ECU & DSENET®

**NOTE:** For further details of module configuration, refer to DSE Publication: *057-243 DSE7310 MKII & 7320 MKII Configuration Software Manual.*

**NOTE:** For further details on connection to electronic engines, refer to DSE Publication: *057-004 Electronic Engines And DSE Wiring*



**NOTE:** Screened 120 Ω impedance cable specified for use with CAN must be used for the CAN link.  
DSE stock and supply Belden cable 9841 which is a high quality 120 Ω impedance cable suitable for CAN use (DSE part number 016-030)

**NOTE:** As a termination resistor is internally fitted to the controller, the controller must be the 'first' unit on the DSENet® link. A termination resistor **MUST** be fitted to the 'last' unit on the DSENet® link. For connection details, refer to section 3.3 entitled *Typical Wiring Diagram* in this document.

	Pin No	Description	Cable Size	Notes
	21	Magnetic Pickup Positive	0.5 mm <sup>2</sup> AWG 20	Connect To Magnetic Pickup Device
	22	Magnetic Pickup Negative	0.5 mm <sup>2</sup> AWG 20	Connect To Magnetic Pickup Device
	23	Magnetic Pickup Screen	Shield	Connect To Ground At One End Only
<b>ECU</b>	24	ECU Port H	0.5 mm <sup>2</sup> AWG 20	Use only 120 Ω CAN or RS485 approved cable
	25	ECU Port L	0.5 mm <sup>2</sup> AWG 20	Use only 120 Ω CAN or RS485 approved cable
	26	ECU Port Screen	Shield	Use only 120 Ω CAN or RS485 approved cable
	27	DSENet® Expansion B	0.5 mm <sup>2</sup> AWG 20	Use only 120 Ω CAN or RS485 approved cable
	28	DSENet® Expansion A	0.5 mm <sup>2</sup> AWG 20	Use only 120 Ω CAN or RS485 approved cable
	29	DSENet® Expansion Screen	Shield	Use only 120 Ω CAN or RS485 approved cable

### 3.2.4 OUTPUT C & D & V1 (GENERATOR) VOLTAGE & FREQUENCY SENSING

**NOTE:** The below table describes connections to a three phase, four wire alternator. For alternative wiring topologies, see section 3.4 entitled *Alternate Topology Wiring Diagrams* in this document.

	Pin No	Description	Cable Size	Notes
	30	Normally Closed Volt-Free Relay Output C	1.0mm <sup>2</sup> AWG 18	Normally configured to control mains contactor coil
	31		1.0mm <sup>2</sup> AWG 18	
	32	Normally Open Volt-Free Relay Output D	1.0mm <sup>2</sup> AWG 18	Normally configured to control generator contactor coil
	33		1.0mm <sup>2</sup> AWG 18	
<b>V1</b>	34	Generator L1 (U) Voltage Sensing	1.0 mm <sup>2</sup> AWG 18	Connect to generator L1 (U) output (AC) (Recommend 2 A fuse)
	35	Generator L2 (V) Voltage Sensing	1.0 mm <sup>2</sup> AWG 18	Connect to generator L2 (V) output (AC) (Recommend 2 A fuse)
	36	Generator L3 (W) Voltage Sensing	1.0 mm <sup>2</sup> AWG 18	Connect to generator L3 (W) output (AC) (Recommend 2 A fuse)
	37	Generator Neutral (N) Input	1.0 mm <sup>2</sup> AWG 18	Connect to generator Neutral terminal (AC)

### 3.2.5 V2 (MAINS) VOLTAGE & FREQUENCY SENSING

**NOTE:** Terminals 38 to 41 not fitted to DSE7310 MKII

**NOTE:** The below table describes connections to a three phase, four wire mains supply. For alternative wiring topologies, see the section 3.4 entitled *Alternate Topology Wiring Diagrams* in this document.

	Pin No	Description	Cable Size	Notes
<b>V2</b>	38	Mains L1 (R) Voltage Sensing	1.0 mm <sup>2</sup> AWG 18	Connect to mains L1 (R) output (AC) (Recommend 2 A fuse)
	39	Mains L2 (S) Voltage Sensing	1.0 mm <sup>2</sup> AWG 18	Connect to mains L2 (S) output (AC) (Recommend 2 A fuse)
	40	Mains L3 (T) Voltage Sensing	1.0 mm <sup>2</sup> AWG 18	Connect to mains L3 (T) output (AC) (Recommend 2 A fuse)
	41	Mains Neutral (N) Input	1.0 mm <sup>2</sup> AWG 18	Connect to Mains Neutral terminal (AC)

### 3.2.6 CURRENT TRANSFORMERS

 **WARNING!** Do not disconnect this plug when the CTs are carrying current. Disconnection open circuits the secondary of the C.T.'s and dangerous voltages may then develop. Always ensure the CTs are not carrying current and the CTs are short circuit connected before making or breaking connections to the module.

 **NOTE:** The module has a burden of 0.25 VA on the CT. Ensure the CT is rated for the burden of the controller, the cable length being used and any other equipment sharing the CT. If in doubt, consult with the CT supplier.

 **NOTE:** Take care to ensure correct polarity of the CT primary as shown below. If in doubt, consult with the CT supplier.

	Pin No	Description	Cable Size	Notes
	42	CT Secondary for L1	2.5 mm <sup>2</sup> AWG 13	Connect to s1 secondary of L1 monitoring CT
	43	CT Secondary for L2	2.5 mm <sup>2</sup> AWG 13	Connect to s1 secondary of L2 monitoring CT
	44	CT Secondary for L3	2.5 mm <sup>2</sup> AWG 13	Connect to s1 secondary of L3 monitoring CT

 **NOTE:** The function of terminals 45 and 46 changes depending upon what type of earth fault protection (if any) is being used:

	Topology	Pin No	Notes	Cable Size
	No earth fault measuring	45	DO NOT CONNECT	
		46	Connect to s2 of the CTs connected to L1,L2,L3,N	2.5mm <sup>2</sup> AWG 13
		47	DO NOT CONNECT	
	Restricted earth fault measuring	45	Connect to s2 of the CTs connected to L1,L2,L3,N	2.5mm <sup>2</sup> AWG 13
		46	Connect to s1 of the CT on the neutral conductor	2.5mm <sup>2</sup> AWG 13
		47	DO NOT CONNECT	
	Un-restricted earth fault measuring (Earth fault CT is fitted in the neutral to earth link)	45	Connect to s2 of the CT on the neutral to earth link.	2.5mm <sup>2</sup> AWG 13
		46	Connect to s1 of the CT on the neutral to earth link. Also connect to the s2 of CTs connected to L1, L2, L3.	2.5mm <sup>2</sup> AWG 13
		47	DO NOT CONNECT	

### 3.2.6.1 CT CONNECTIONS

p1,  $\bar{k}$  or K is the primary of the CT that 'points' towards the Generator

p2,  $\bar{l}$  or L is the primary of the CT that 'points' towards the Load

s1 is the secondary of the CT that connects to the DSE Module's input for the CT measuring

s2 is the secondary of the CT that should be commoned with the s2 connections of all the other CTs and connected to the CT common terminal of the module.

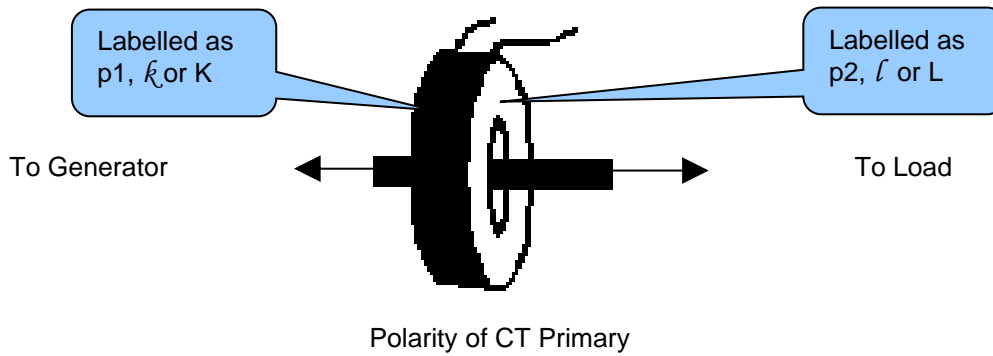

### 3.2.7 DIGITAL INPUTS

**NOTE:** For further details of module configuration, refer to DSE Publication: **057-243 DSE7310 MKII & 7320 MKII Configuration Software Manual.**

	Pin No	Description	Cable Size	Notes
	48	Configurable Digital Input A	0.5 mm <sup>2</sup> AWG 20	Switch To Negative
	49	Configurable Digital Input B	0.5 mm <sup>2</sup> AWG 20	Switch To Negative
	50	Configurable Digital Input C	0.5 mm <sup>2</sup> AWG 20	Switch To Negative
	51	Configurable Digital Input D	0.5 mm <sup>2</sup> AWG 20	Switch To Negative
	52	Configurable Digital Input E	0.5 mm <sup>2</sup> AWG 20	Switch To Negative
	53	Configurable Digital Input F	0.5 mm <sup>2</sup> AWG 20	Switch To Negative
	54	Configurable Digital Input G	0.5 mm <sup>2</sup> AWG 20	Switch To Negative
	55	Configurable Digital Input H	0.5 mm <sup>2</sup> AWG 20	Switch To Negative

### 3.2.8 RS485

**NOTE:** For further details of module configuration, refer to DSE Publication: *057-243 DSE7310 MKII & 7320 MKII Configuration Software Manual*.

**NOTE:** A 120 Ω termination resistor must be fitted across terminals A and B if the DSE module is the first or last device on the R485 link.

**NOTE:** Screened 120 Ω impedance cable specified for use with RS485 must be used for the RS485 link.  
DSE stock and supply Belden cable 9841 which is a high quality 120 Ω impedance cable suitable for CAN use (DSE part number 016-030)

	Pin No	Description	Cable Size	Notes
<b>RS485</b>	56	RS485 Port Screen	Shield	Use only 120 Ω CAN or RS485 approved cable
	57	RS485 Port B (+)	0.5 mm <sup>2</sup> AWG 20	Connect to RXD+ and TXD+ Use only 120 Ω CAN or RS485 approved cable
	58	RS485 Port A (-)	0.5 mm <sup>2</sup> AWG 20	Connect to RXD- and TXD- Use only 120 Ω CAN or RS485 approved cable

### 3.2.9 RS232

**NOTE:** For further details of module configuration, refer to DSE Publication: *057-243 DSE7310 MKII & 7320 MKII Configuration Software Manual*.

	Description	Notes
	Socket for connection to a modem or PC with DSE Configuration Suite Software	Supports MODBUS RTU protocol or external modem

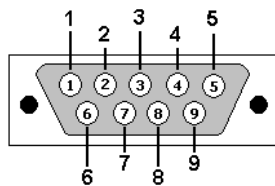

View looking into the male connector on the module



PIN No	Notes
1	Received Line Signal Detector (Data Carrier Detect)
2	Received Data
3	Transmit Data
4	Data Terminal Ready
5	Signal Ground
6	Data Set Ready
7	Request To Send
8	Clear To Send
9	Ring Indicator

### 3.2.10 USB SLAVE (PC CONFIGURATION) CONNECTOR

**NOTE:** The USB connection cable between the PC and the module must not be extended beyond 5 m (yards). For distances over 5 m, it is possible to use a third-party USB extender. Typically, they extend USB up to 50 m. The supply and support of this type of equipment is outside the scope of Deep Sea Electronics Ltd.

**CAUTION!** Care must be taken not to overload the PC's USB system by connecting more than the recommended number of USB devices to the PC. For further information, consult your PC supplier.

**NOTE:** For further details of module configuration, refer to DSE Publication: *057-243 DSE7310 MKII & 7320 MKII Configuration Software Manual*.

	Description	Cable Size	Notes
	Socket for connection to PC with DSE Configuration Suite Software	0.5 mm <sup>2</sup> AWG 20	This is a standard USB type A to type B connector. 



### 3.3 TYPICAL WIRING DIAGRAM

As every system has different requirements, these diagrams show only a typical system and do not intend to show a complete system.

Genset manufacturers and panel builders may use these diagrams as a starting point; however always refer to the completed system diagram provided by the system manufacturer for complete wiring detail.

Further wiring suggestions are available in the following DSE publications, available at [www.deepseaelectronics.com](http://www.deepseaelectronics.com) to website members.

DSE Part	Description
056-005	Using CTs With DSE Products
056-022	Breaker Control
056-091	Equipotential Earth Bonding
056-092	Best Practices for Wiring Resistive Sensors

### 3.3.1 DSE7310 MKII (3 PHASE 4 WIRE) WITH RESTRICTED EARTH FAULT

**NOTE:** The below diagram is applicable for the following AC topologies: 3 Phase 4 Wire Star, 3 Phase 4 Wire Delta L1-N-L2, 3 Phase 4 Wire Delta L1-N-L3 and 3 Phase 4 Wire Delta L2-N-L3. For further details of module configuration to suit these different topologies, refer to DSE Publication: 057-243 *DSE7310 MKII & 7320 MKII Configuration Software Manual*.

**NOTE:** Earthing the neutral conductor 'before' the neutral CT allows the module to read earth faults 'after' the CT only (Restricted to load / downstream of the CT)  
 Earthing the neutral conductor 'after' the neutral CT allows the module to read earth faults 'before' the CT only (Restricted to generator / upstream of the CT)

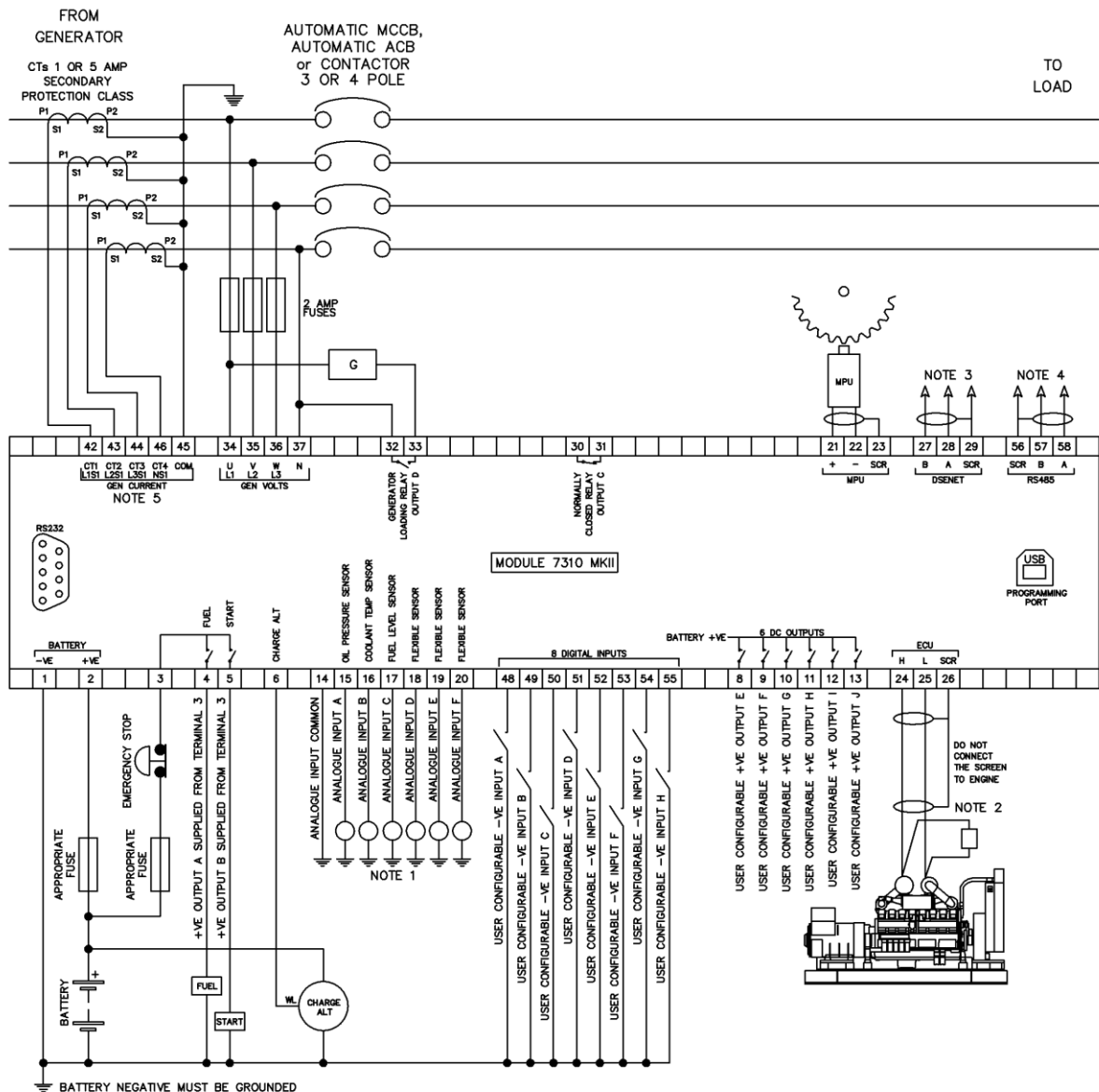

**NOTE 1:** THESE GROUND CONNECTIONS MUST BE ON THE ENGINE BLOCK, AND MUST BE TO THE SENSOR BODIES.

**NOTE 2:** A 120 OHM TERMINATING RESISTOR MAY BE REQUIRED EXTERNALLY, SEE ENGINE MANUFACTURERS LITERATURE.

**NOTE 3:** MUST BE FITTED AS FIRST OR LAST UNIT ON THE DSENET LINK WITH NO EXTERNAL TERMINATION RESISTOR. THE SUBSEQUENT FIRST OR LAST UNIT ON DSENET MUST BE FITTED WITH A 120 OHM TERMINATION RESISTOR ACROSS TERMINALS A AND B.

**NOTE 4:** IF THE MODULE IS FIRST OR LAST UNIT ON THE LINK IT MUST BE FITTED WITH AN EXTERNAL 120 OHM TERMINATION RESISTOR ACROSS TERMINALS A AND B OR H AND L.

**NOTE 5:** WHEN THE 4TH CT IS PLACED ON THE NEUTRAL, TERMINAL 45 IS THE CT COMMON. WHEN THE 4TH IS NOT IN USE OR PLACED ON THE EARTH CONNECTION, TERMINAL 46 IS THE CT COMMON

3.3.2 DSE7320 MKII (3 PHASE 4 WIRE) WITH RESTRICTED EARTH FAULT

**NOTE:** The below diagram is applicable for the following AC topologies: 3 Phase 4 Wire Star, 3 Phase 4 Wire Delta L1-N-L2, 3 Phase 4 Wire Delta L1-N-L3 and 3 Phase 4 Wire Delta L2-N-L3. For further details of module configuration to suit these different topologies, refer to DSE Publication: 057-243 DSE7310 MKII & 7320 MKII Configuration Software Manual.

**NOTE:** Earthing the neutral conductor 'before' the neutral CT allows the module to read earth faults 'after' the CT only (Restricted to load / downstream of the CT)  
 Earthing the neutral conductor 'after' the neutral CT allows the module to read earth faults 'before' the CT only (Restricted to generator / upstream of the CT)

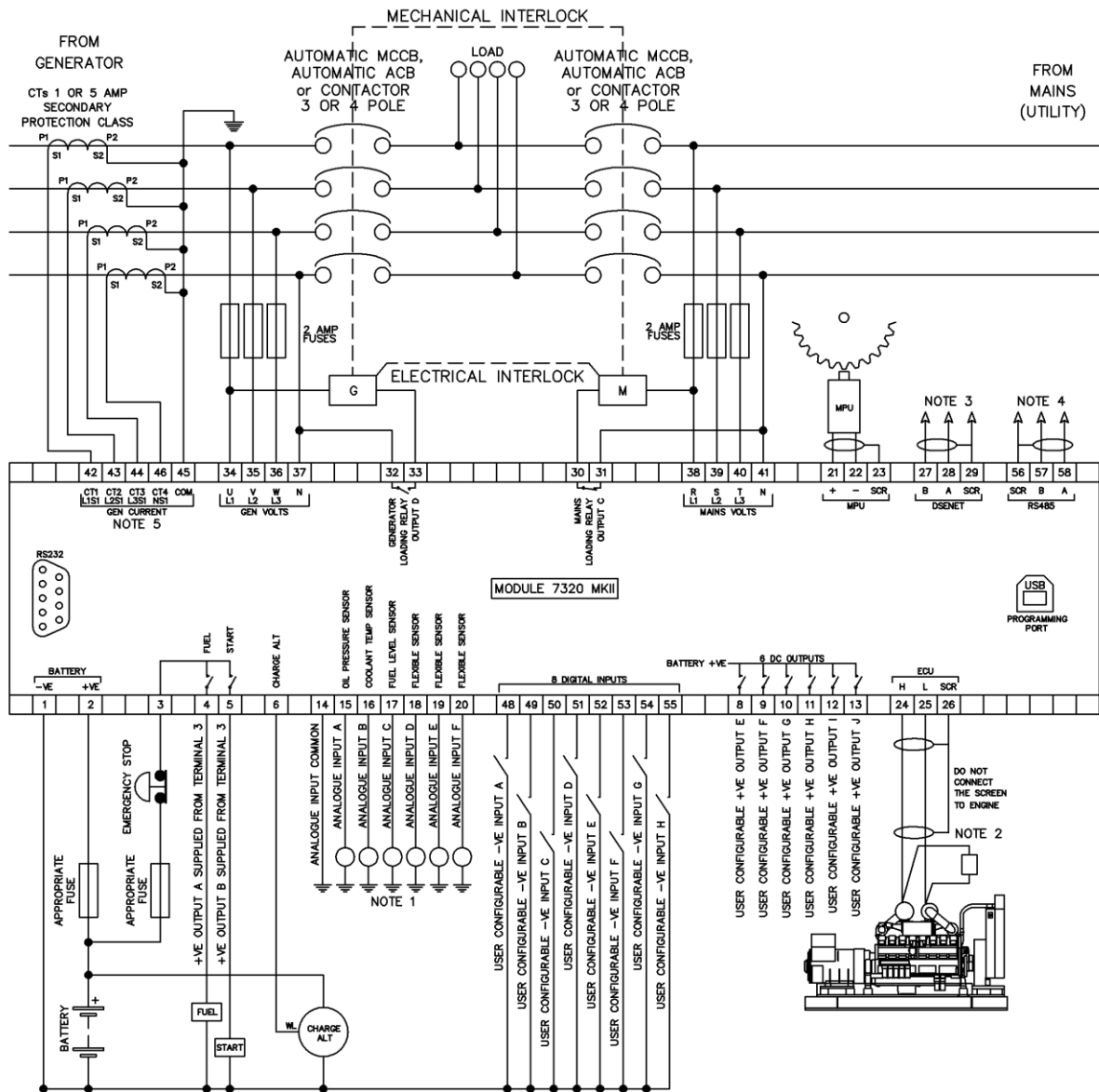

BATTERY NEGATIVE MUST BE GROUNDED  
 NOTE 1. THESE GROUND CONNECTIONS MUST BE ON THE ENGINE BLOCK, AND MUST BE TO THE SENSOR BODIES.  
 NOTE 2. A 120 OHM TERMINATING RESISTOR MAY BE REQUIRED EXTERNALLY, SEE ENGINE MANUFACTURERS LITERATURE.  
 NOTE 3. MUST BE FITTED AS FIRST OR LAST UNIT ON THE DSENET LINK WITH NO EXTERNAL TERMINATION RESISTOR. THE SUBSEQUENT FIRST OR LAST UNIT ON DSENET MUST BE FITTED WITH A 120 OHM TERMINATION RESISTOR ACROSS TERMINALS A AND B.

NOTE 4. IF THE MODULE IS FIRST OR LAST UNIT ON THE LINK IT MUST BE FITTED WITH AN EXTERNAL 120 OHM TERMINATION RESISTOR ACROSS TERMINALS A AND B OR H AND L.  
 NOTE 5. WHEN THE 4TH CT IS PLACED ON THE NEUTRAL, TERMINAL 45 IS THE CT COMMON. WHEN THE 4TH IS NOT IN USE OR PLACED ON THE EARTH CONNECTION, TERMINAL 46 IS THE CT COMMON

### 3.3.3 EARTH SYSTEMS

#### 3.3.3.1 NEGATIVE EARTH

The typical wiring diagrams located within this document show connections for a negative earth system (the battery negative connects to Earth).

#### 3.3.3.2 POSITIVE EARTH

When using a DSE module with a Positive Earth System (the battery positive connects to Earth), the following points must be followed:

Follow the typical wiring diagram as normal for all sections **except** the earth points. All points shown as Earth on the typical wiring diagram should connect to **battery negative** (not earth).

#### 3.3.3.3 FLOATING EARTH

Where neither the battery positive nor battery negative terminals are connected to earth the following points must be followed:

Follow the typical wiring diagram as normal for all sections **except** the earth points. All points shown as Earth on the typical wiring diagram should connect to **battery negative** (not earth).

### 3.3.4 TYPICAL ARRANGEMENT OF DSENET®

**NOTE:** For further details of module configuration, refer to DSE Publication: 057-243 *DSE7310 MKII & DSE7320 MKII Configuration Software Manual.*

**NOTE:** This feature is not available if the DSE73xx MKII module has been configured to use the DSENet® port as the interface to a Cummins MODBUS GCS ECU.

**NOTE:** Screened 120 Ω impedance cable specified for use with CAN must be used for the DSENet® (RS485) connection.

DSE stock and supply Belden cable 9841 which is a high quality 120Ω impedance cable suitable for DSENet® use (DSE part number 016-030)

Twenty (20) devices can be connected to the DSENet®, made up of the following devices :

Device	Maximum Number Supported
DSE2130 Input Expansion	4
DSE2131 Ratiometric Input Expansion	4
DSE2133 RTD/Thermocouple Input Expansion	4
DSE2152 Analogue Output Expansion	4
DSE2157 Relay Output Expansion	10
DSE2510 or DSE2520 Remote Display	3
DSE2548 LED Expansion	10
DSE Intelligent Battery Chargers	4

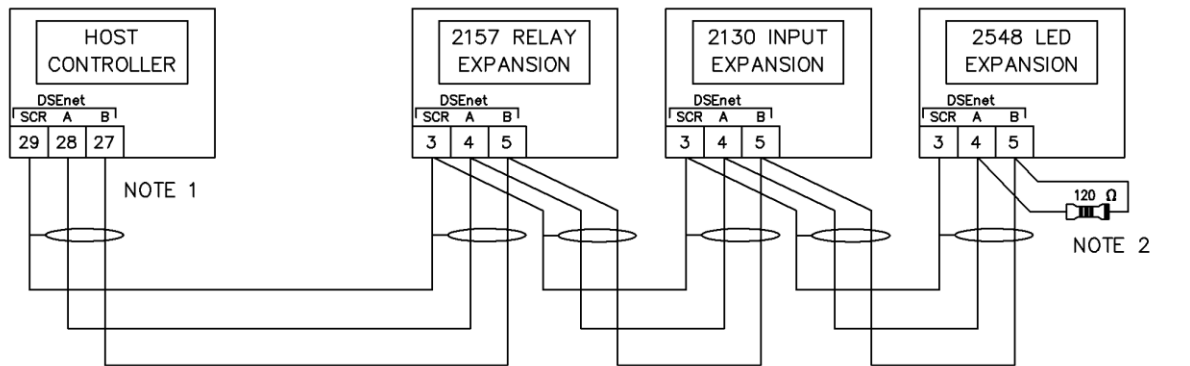

NOTE 1  
AS A TERMINATING RESISTOR IS INTERNALLY FITTED TO THE HOST CONTROLLER, THE HOST CONTROLLER MUST BE THE FIRST LAST UNIT ON THE DSEnet

NOTE 2  
A 120 OHM TERMINATION RESISTOR MUST BE FITTED TO THE LAST UNIT ON THE DSEnet

### 3.3.5 TYPICAL ARRANGEMENT OF CAN

**NOTE:** For further details of module configuration, refer to DSE Publication: *057-243 DSE7310 MKII & DSE7320 MKII Configuration Software Manual.*

**NOTE:** Screened 120 Ω impedance cable specified for use with CAN must be used. DSE stock and supply Belden cable 9841 which is a high quality 120 Ω impedance cable suitable for DSENet® use (DSE part number 016-030)

#### 3.3.5.1 ECU PORT

Typically, the ECU port on the controller is used for connection to an engine ECU/ECM though depending upon module configuration, may be connected to additional CAN devices.

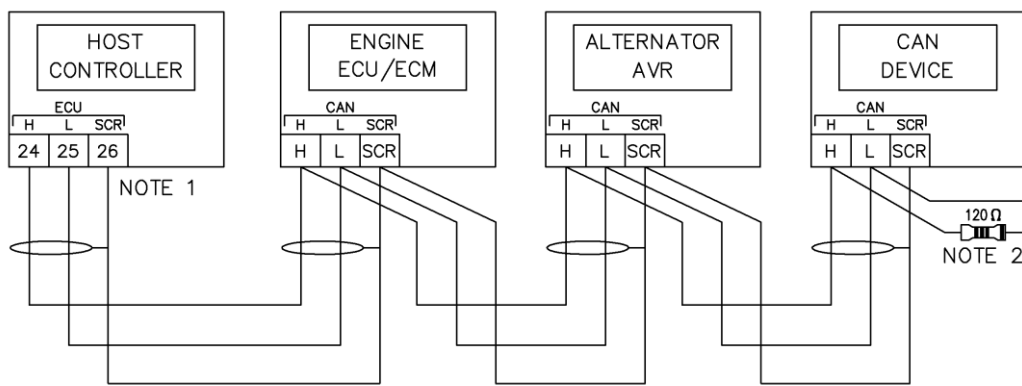

**NOTE 1**  
AS A TERMINATING RESISTOR IS INTERNALLY FITTED TO CONTROLLER, THE CONTROLLER MUST BE THE FIRST OR LAST DEVICE ON THE CAN LINK.

**NOTE 2**  
A 120 OHM TERMINATION RESISTOR MUST BE FITTED TO THE FIRST AND LAST UNIT ON THE CAN LINK

### 3.3.6 DUAL MUTUAL STANDBY SINGLE LINE DIAGRAMS

#### 3.3.6.1 TWO DSE7310 MKII

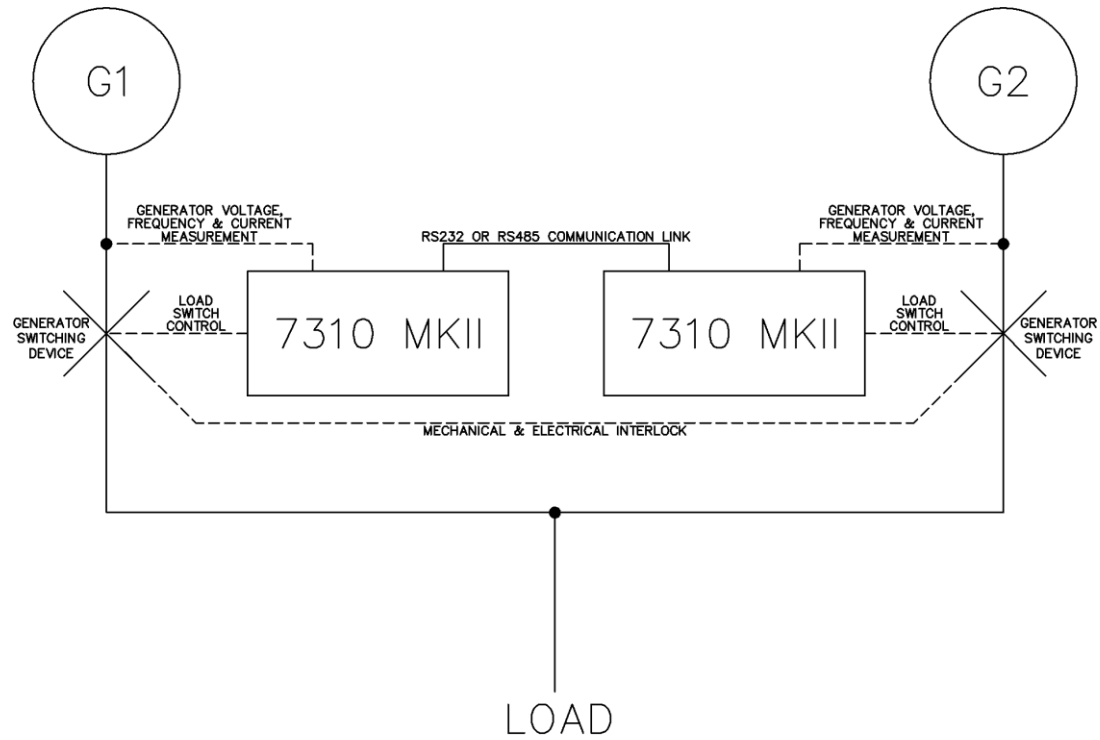

3.3.6.2 TWO DSE7320 MKII

**NOTE:** Mains load switch control signals are required from both DSE7320 MKII. However, only one DSE7320 MKII control the mains load switch at any time to avoid conflicting control signals. For more details refer to section 6 entitled *Operation (Dual Mutual Standby)* in this document.

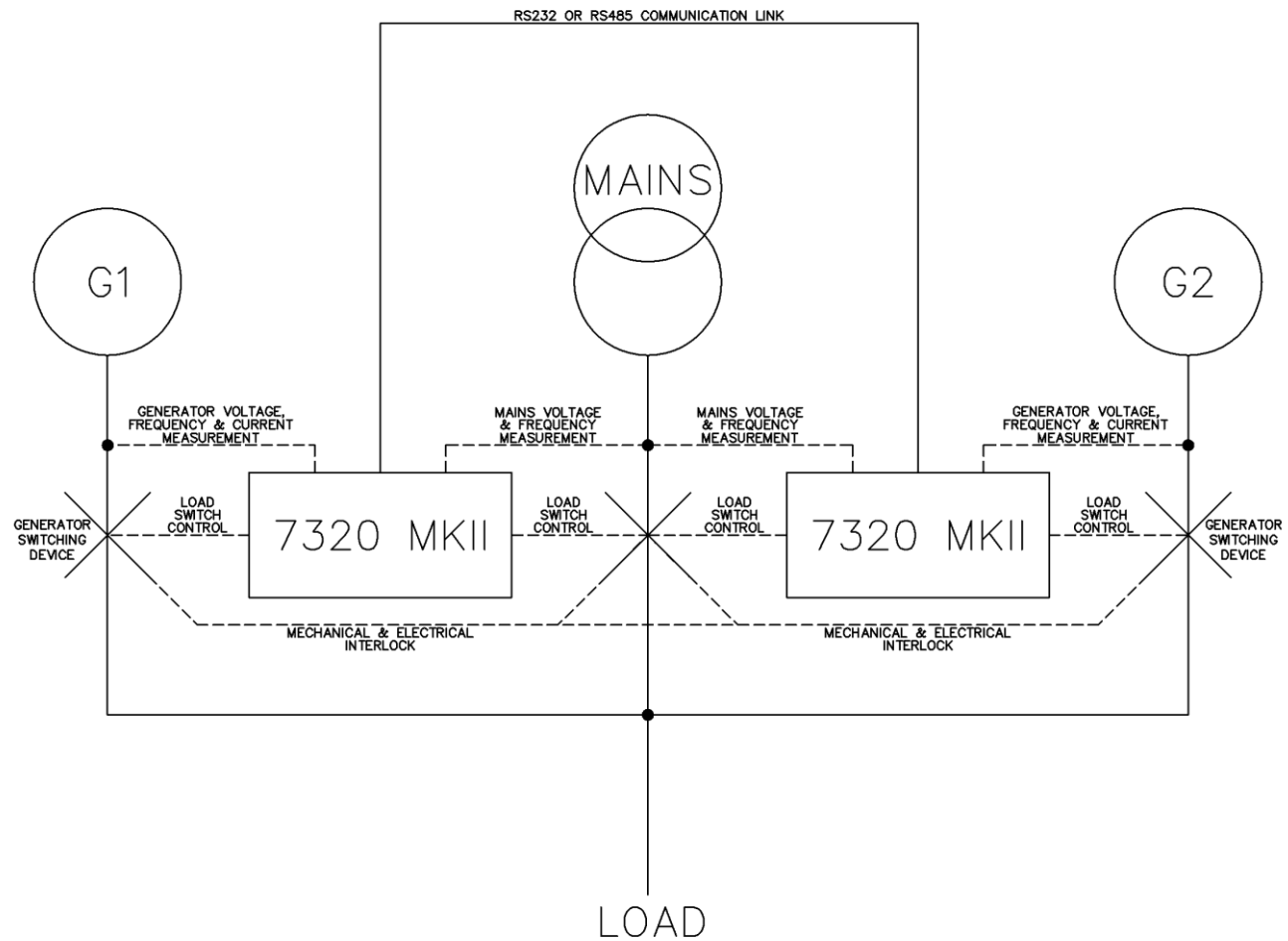



3.3.6.3 TWO DSE73XX MKII USING DIGITAL INPUTS AND OUTPUTS

**NOTE:** The *Dual Mutual Standby* input or output functions are configured on any of the DSE73xx MKII module's Digital Inputs or Digital Outputs.

The hardwired input and output signals between the controllers are used to provide a failsafe for the system. In the event of a module being out of service (battery removed), communication failure or generator failure, the output of that controller de-energises, giving the ok to run signal to the other controller.

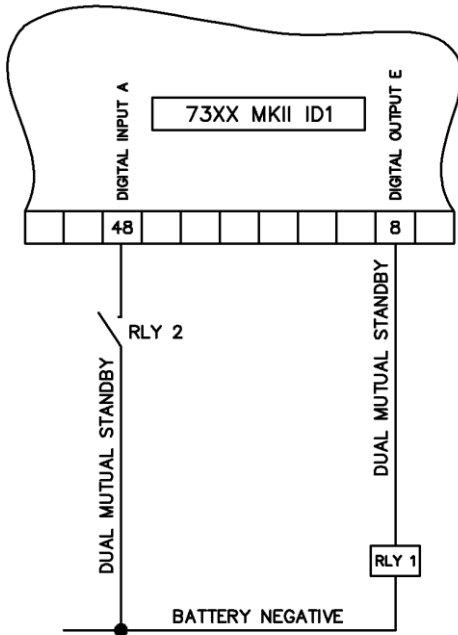

In case of set 1 failure, the output activates and energises the external relay RLY1 to call for the second set to start.

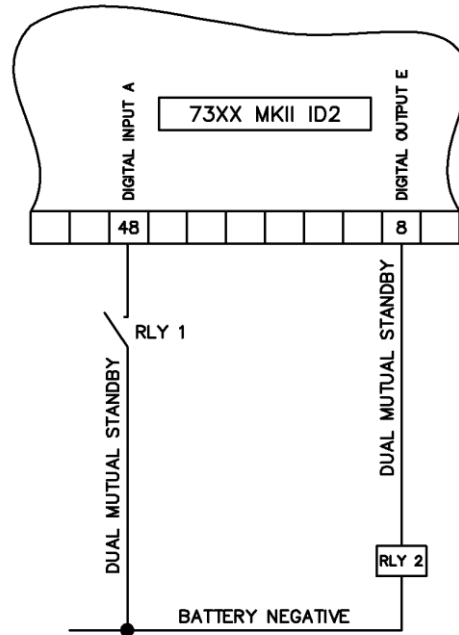

RLY1 contact closes a battery negative signal onto the input, instructing the set to start.

### 3.4 ALTERNATE TOPOLOGY WIRING DIAGRAMS

#### 3.4.1 SINGLE PHASE 2 WIRE WITH RESTRICTED EARTH FAULT

**NOTE:** Earthing the neutral conductor 'before' the neutral CT allows the module to read earth faults 'after' the CT only (Restricted to load / downstream of the CT)  
 Earthing the neutral conductor 'after' the neutral CT allows the module to read earth faults 'before' the CT only (Restricted to generator / upstream of the CT)

**NOTE:** The mains sensing terminals 38 to 41 are not fitted to the DSE7310 MKII.

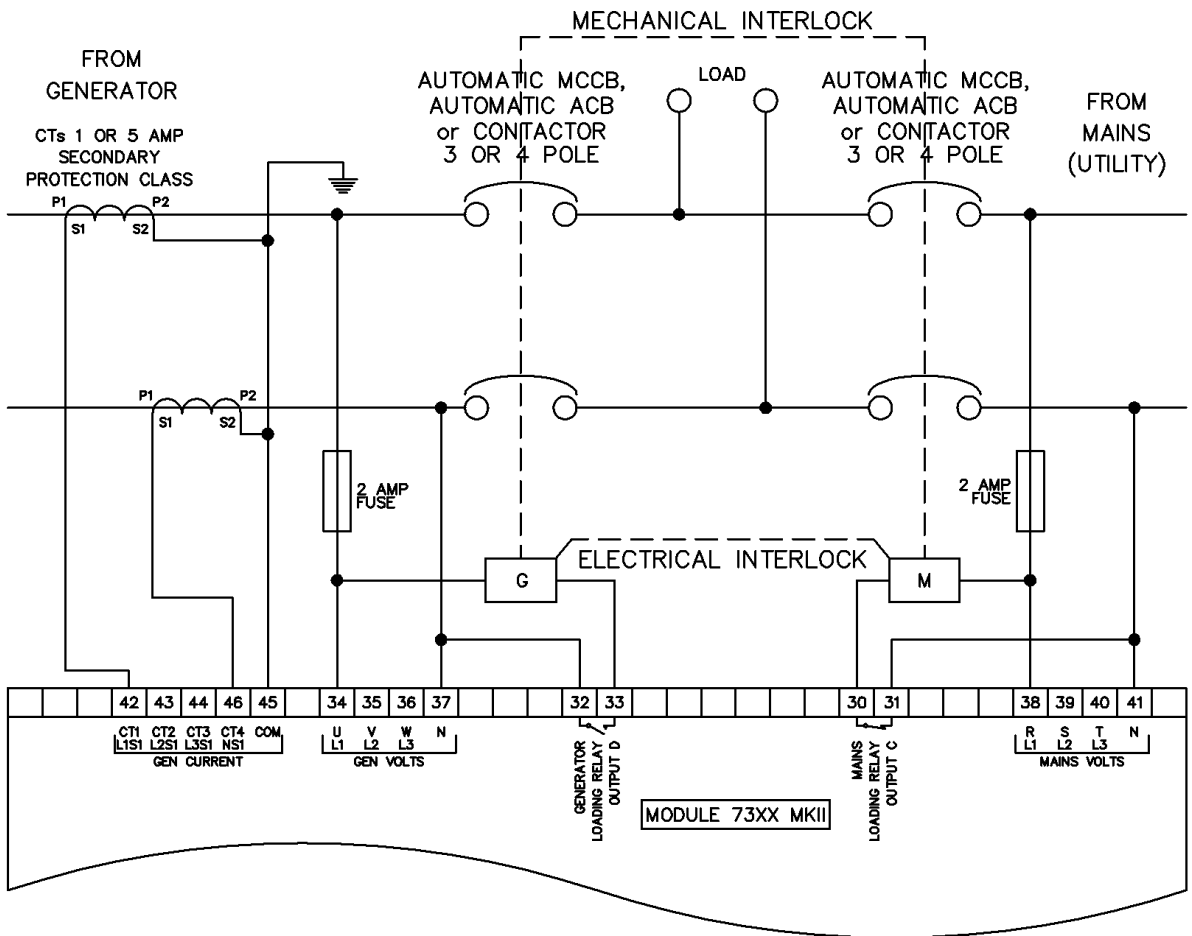

3.4.2 SINGLE PHASE 2 WIRE WITHOUT EARTH FAULT

**NOTE:** The mains sensing terminals 38 to 41 are not fitted to the DSE7310 MKII.

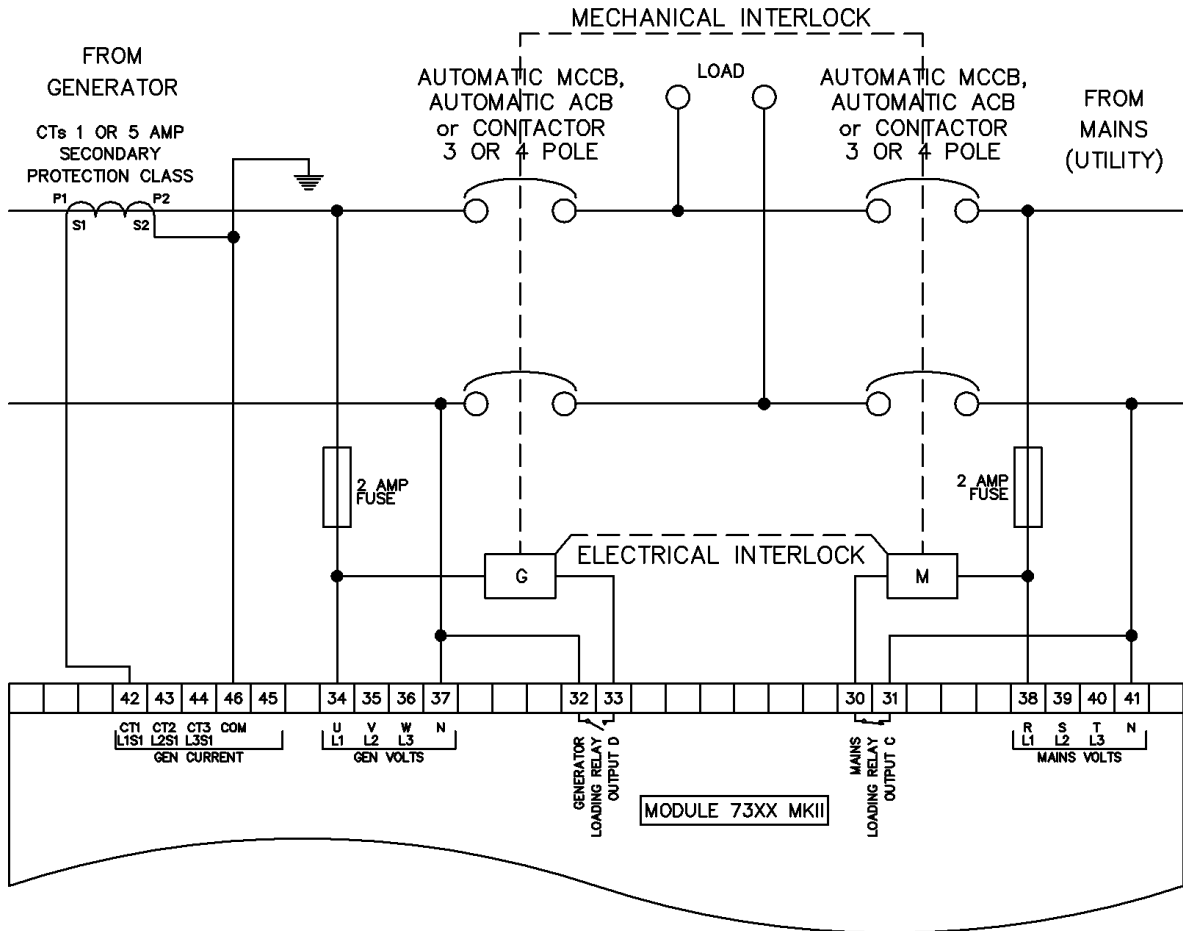

### 3.4.3 SINGLE PHASE (L1 & L2) 3 WIRE WITH RESTRICTED EARTH FAULT

**NOTE:** Earthing the neutral conductor 'before' the neutral CT allows the module to read earth faults 'after' the CT only (Restricted to load / downstream of the CT)  
 Earthing the neutral conductor 'after' the neutral CT allows the module to read earth faults 'before' the CT only (Restricted to generator / upstream of the CT)

**NOTE:** The mains sensing terminals 38 to 41 are not fitted to the DSE7310 MKII.

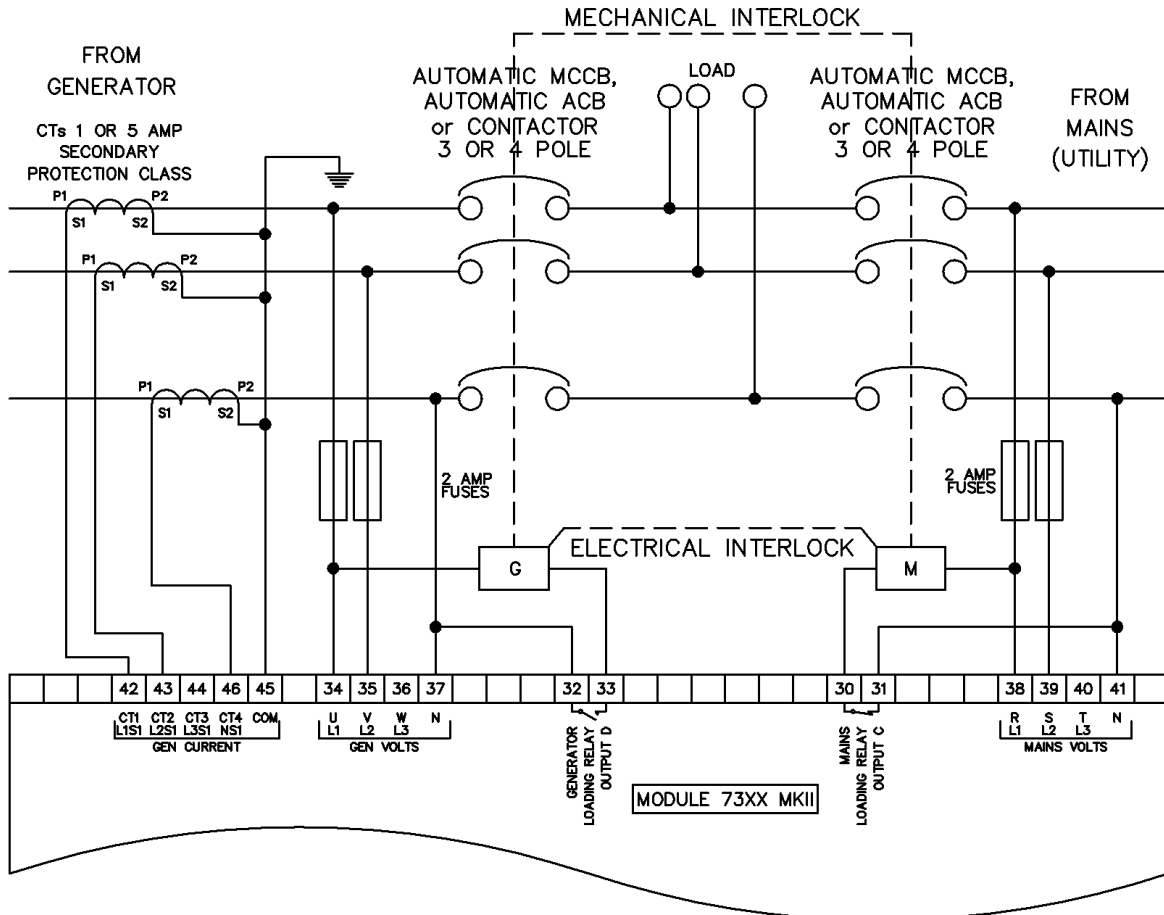

3.4.4 SINGLE PHASE (L1 & L2) 3 WIRE WITHOUT EARTH FAULT

**NOTE:** The mains sensing terminals 38 to 41 are not fitted to the DSE7310 MKII.

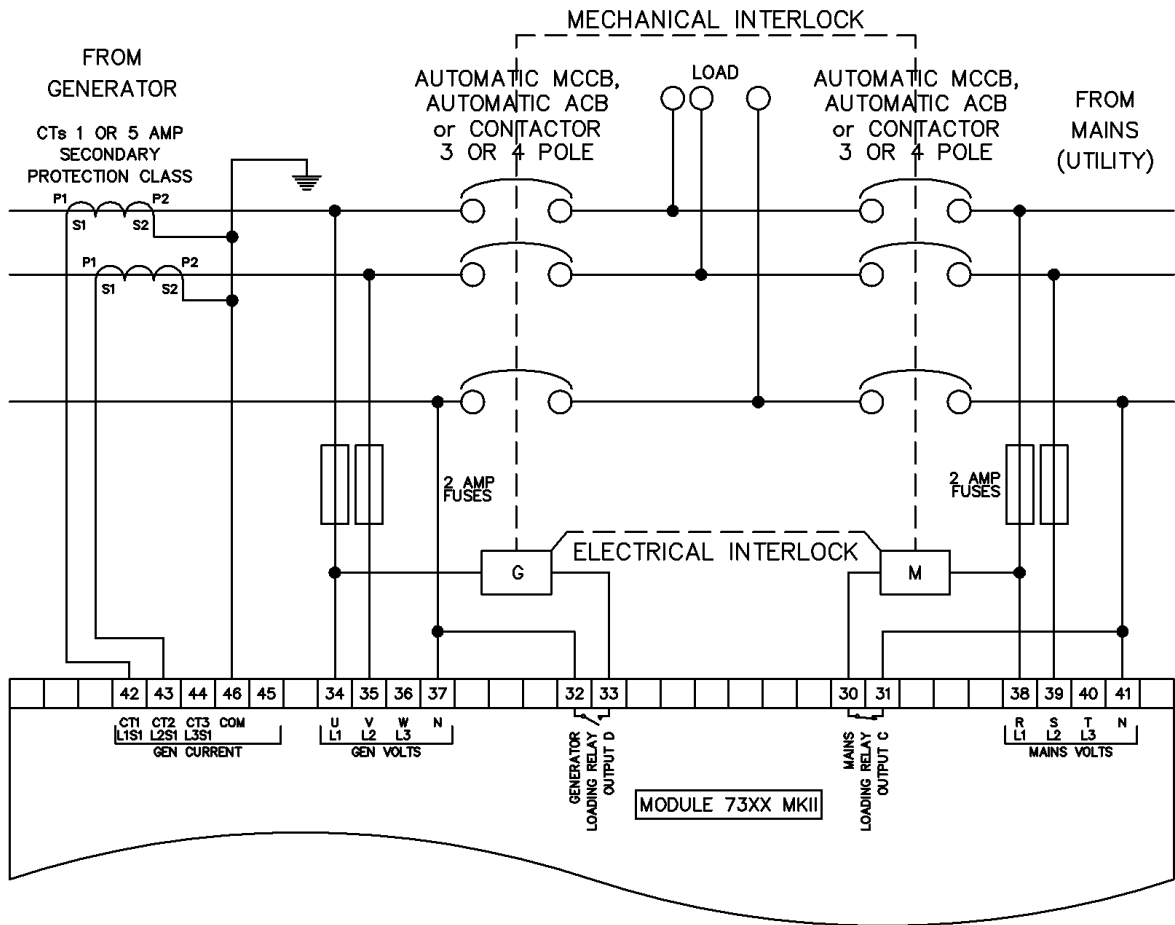

3.4.5 SINGLE PHASE (L1 & L3) 3 WIRE WITH EESTRICTED EARTH FAULT

**NOTE:** Earthing the neutral conductor 'before' the neutral CT allows the module to read earth faults 'after' the CT only (Restricted to load / downstream of the CT)  
 Earthing the neutral conductor 'after' the neutral CT allows the module to read earth faults 'before' the CT only (Restricted to generator / upstream of the CT)

**NOTE:** The mains sensing terminals 38 to 41 are not fitted to the DSE7310 MKII.

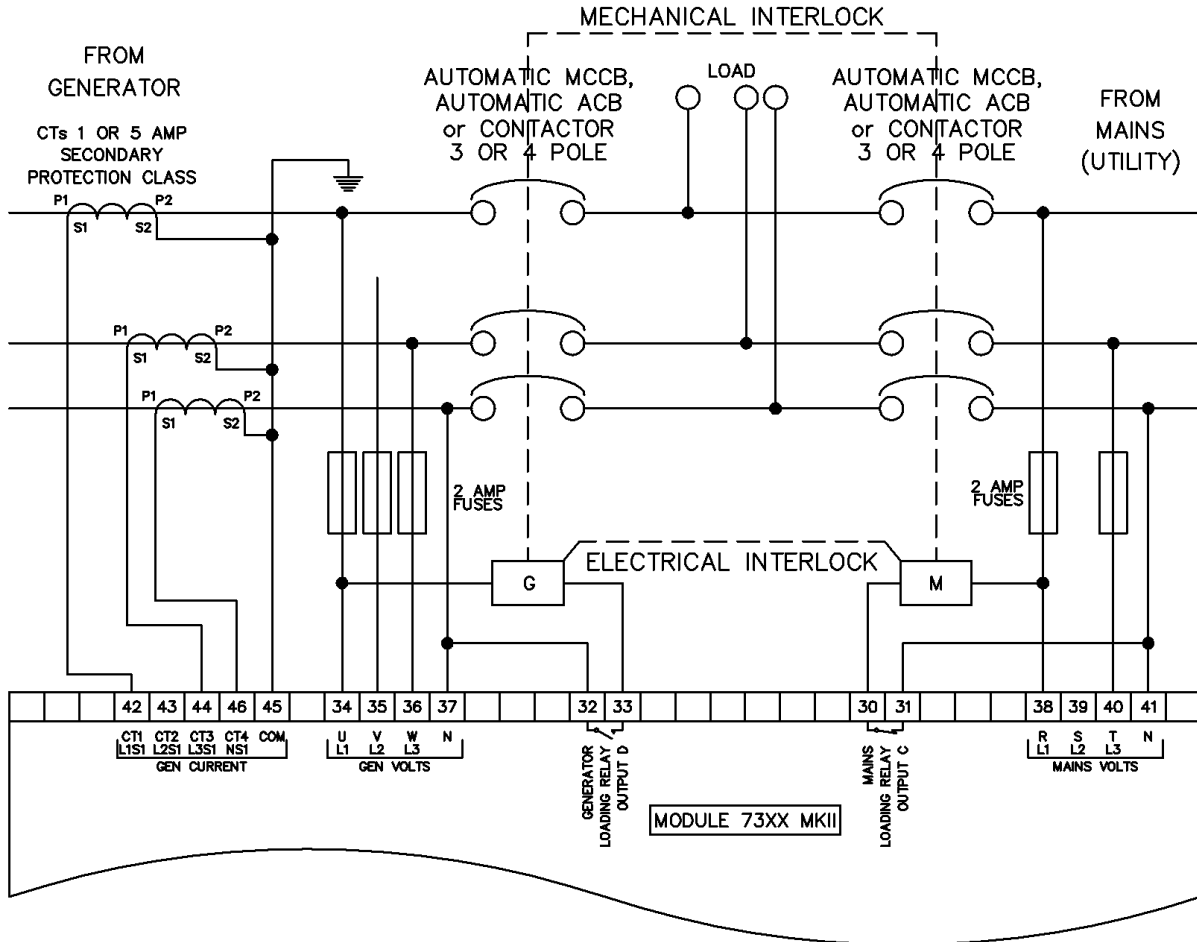

3.4.6 SINGLE PHASE (L1 & L3) 3 WIRE WITHOUT EARTH FAULT

**NOTE:** The mains sensing terminals 38 to 41 are not fitted to the DSE7310 MKII.

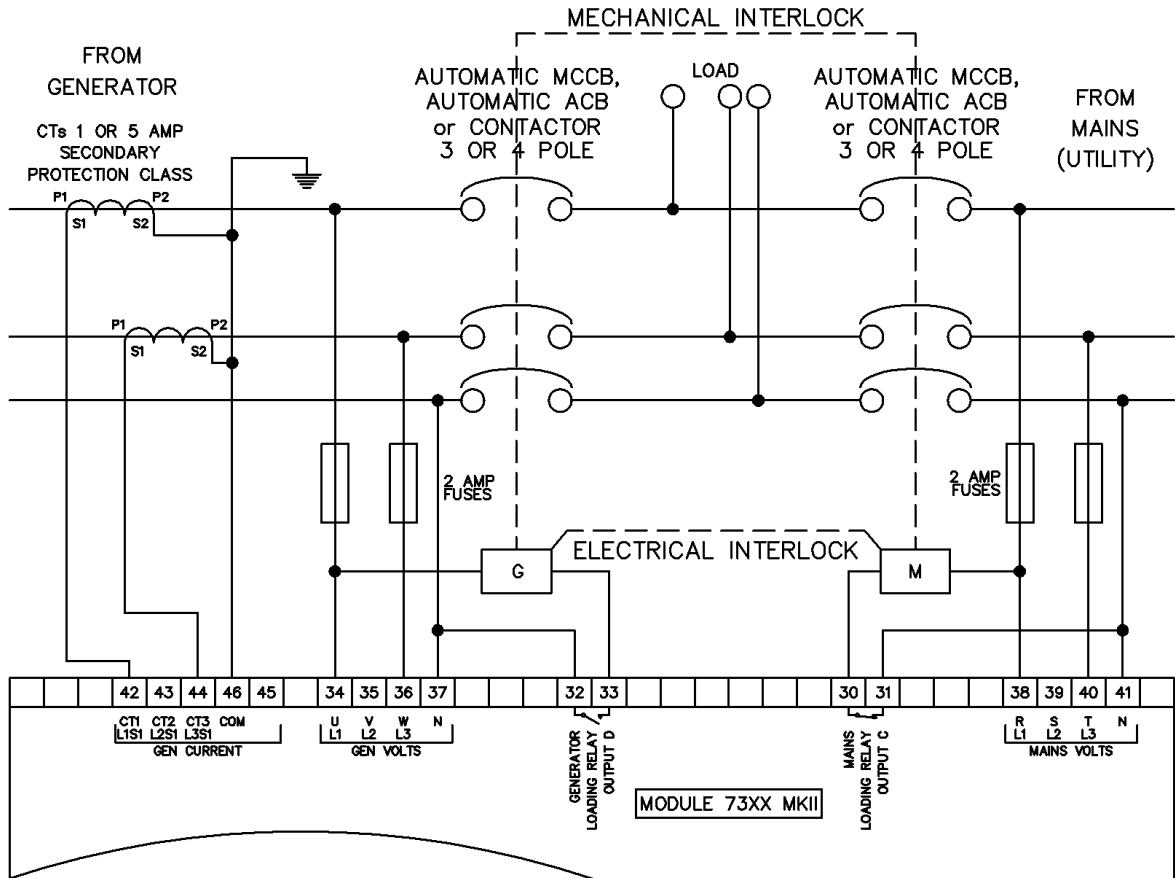

3.4.7 2 PHASE (L1 & L2) 3 WIRE WITH RESTRICTED EARTH FAULT

**NOTE:** Earthing the neutral conductor 'before' the neutral CT allows the module to read earth faults 'after' the CT only (Restricted to load / downstream of the CT)  
 Earthing the neutral conductor 'after' the neutral CT allows the module to read earth faults 'before' the CT only (Restricted to generator / upstream of the CT)

**NOTE:** The mains sensing terminals 38 to 41 are not fitted to the DSE7310 MKII.

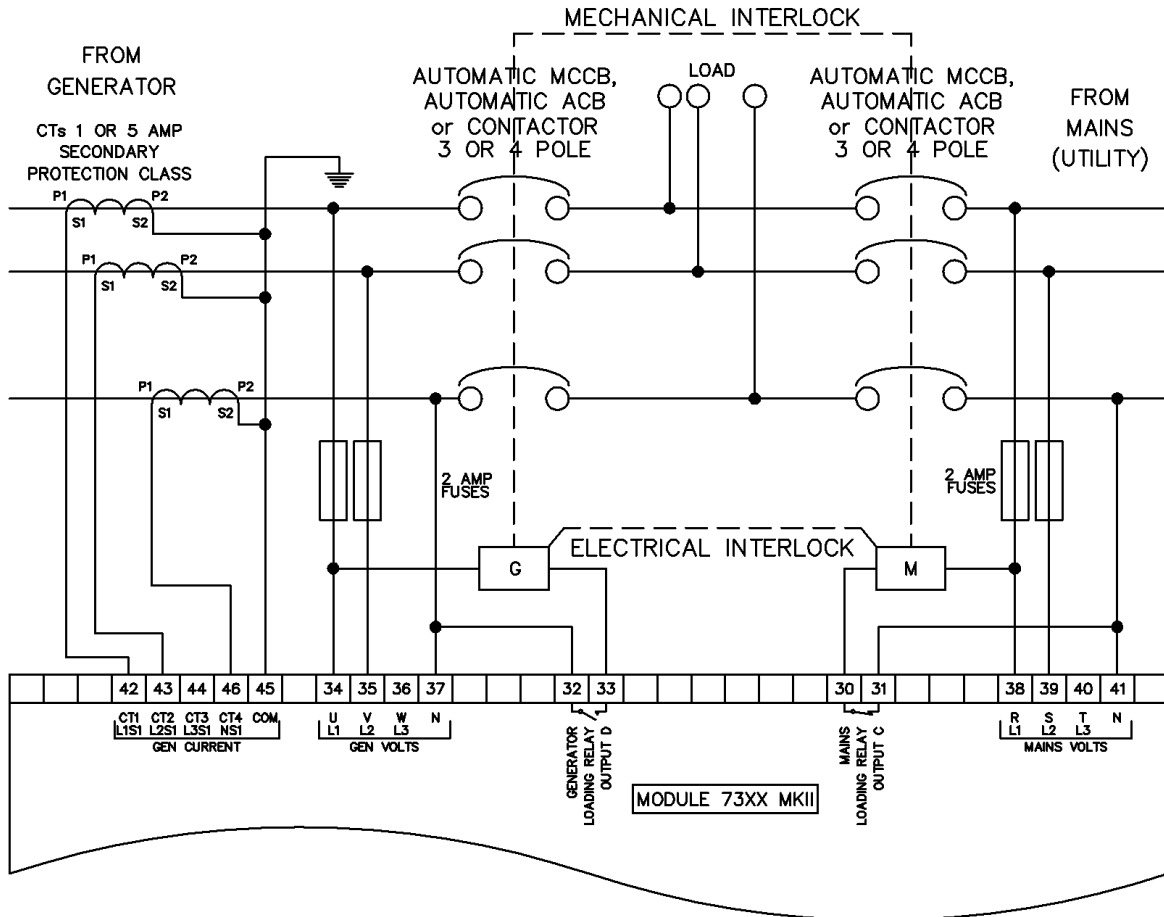



3.4.8 2 PHASE (L1 & L2) 3 WIRE WITHOUT EARTH FAULT

**NOTE:** The mains sensing terminals 38 to 41 are not fitted to the DSE7310 MKII.

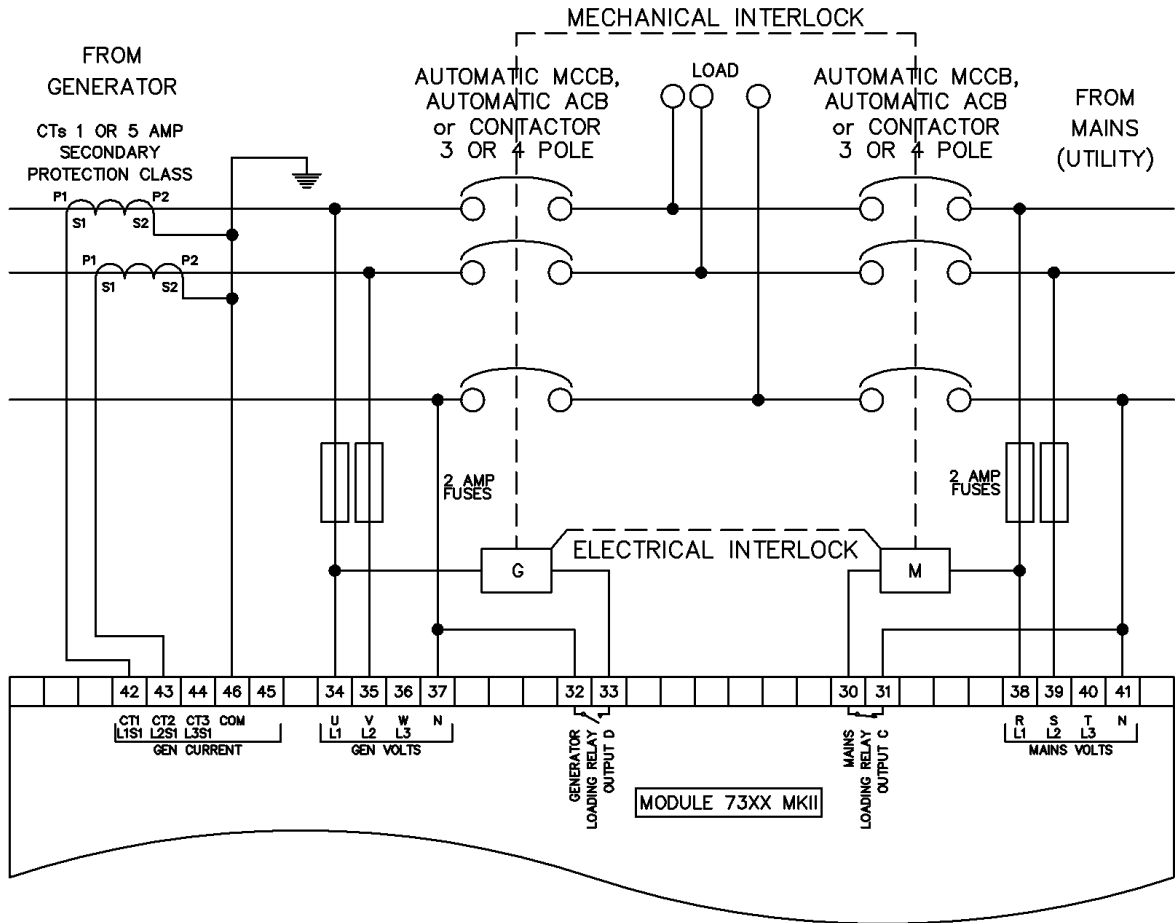

3.4.9 2 PHASE (L1 & L3) 3 WIRE WITH RESTRICTED EARTH FAULT

**NOTE:** Earthing the neutral conductor 'before' the neutral CT allows the module to read earth faults 'after' the CT only (Restricted to load / downstream of the CT)  
 Earthing the neutral conductor 'after' the neutral CT allows the module to read earth faults 'before' the CT only (Restricted to generator / upstream of the CT)

**NOTE:** The mains sensing terminals 38 to 41 are not fitted to the DSE7310 MKII.

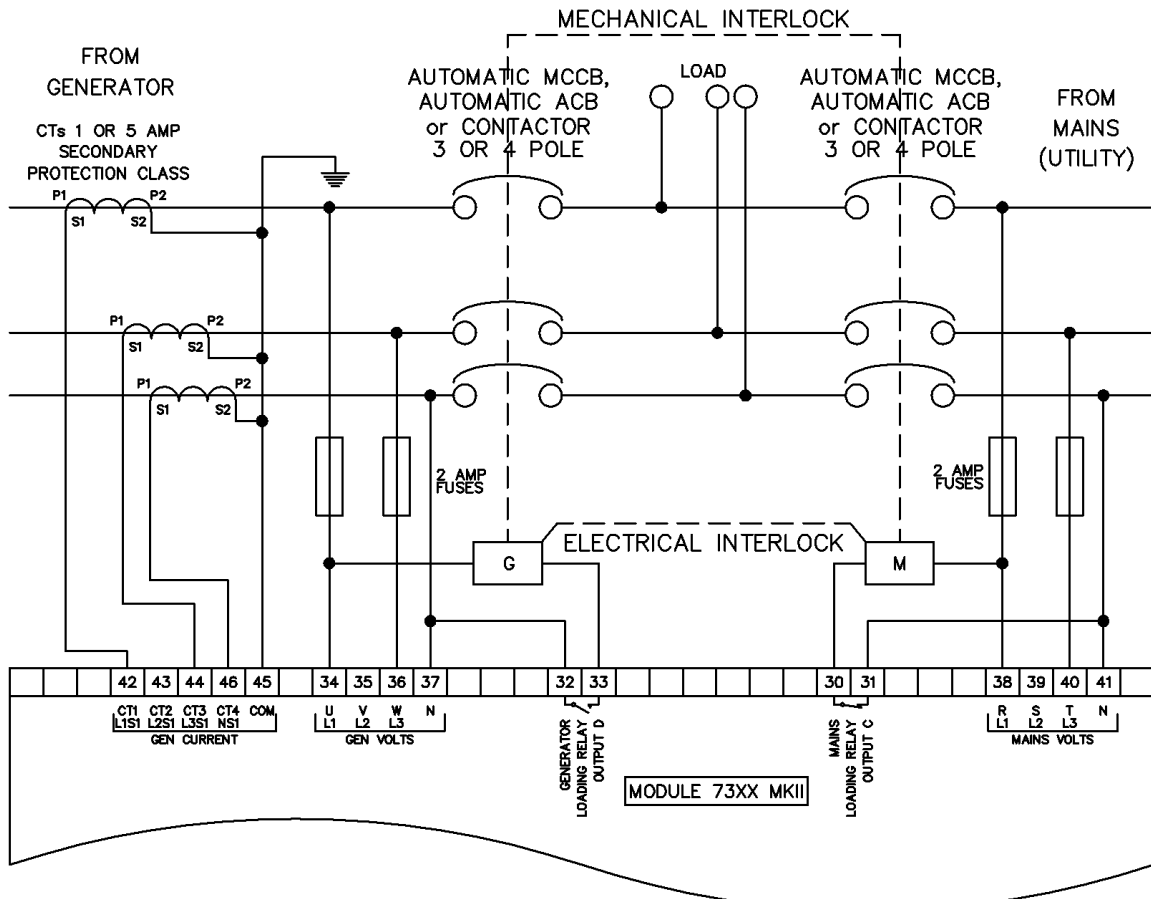

3.4.10 2 PHASE (L1 & L3) 3 WIRE WITHOUT EARTH FAULT

**NOTE:** The mains sensing terminals 38 to 41 are not fitted to the DSE7310 MKII.

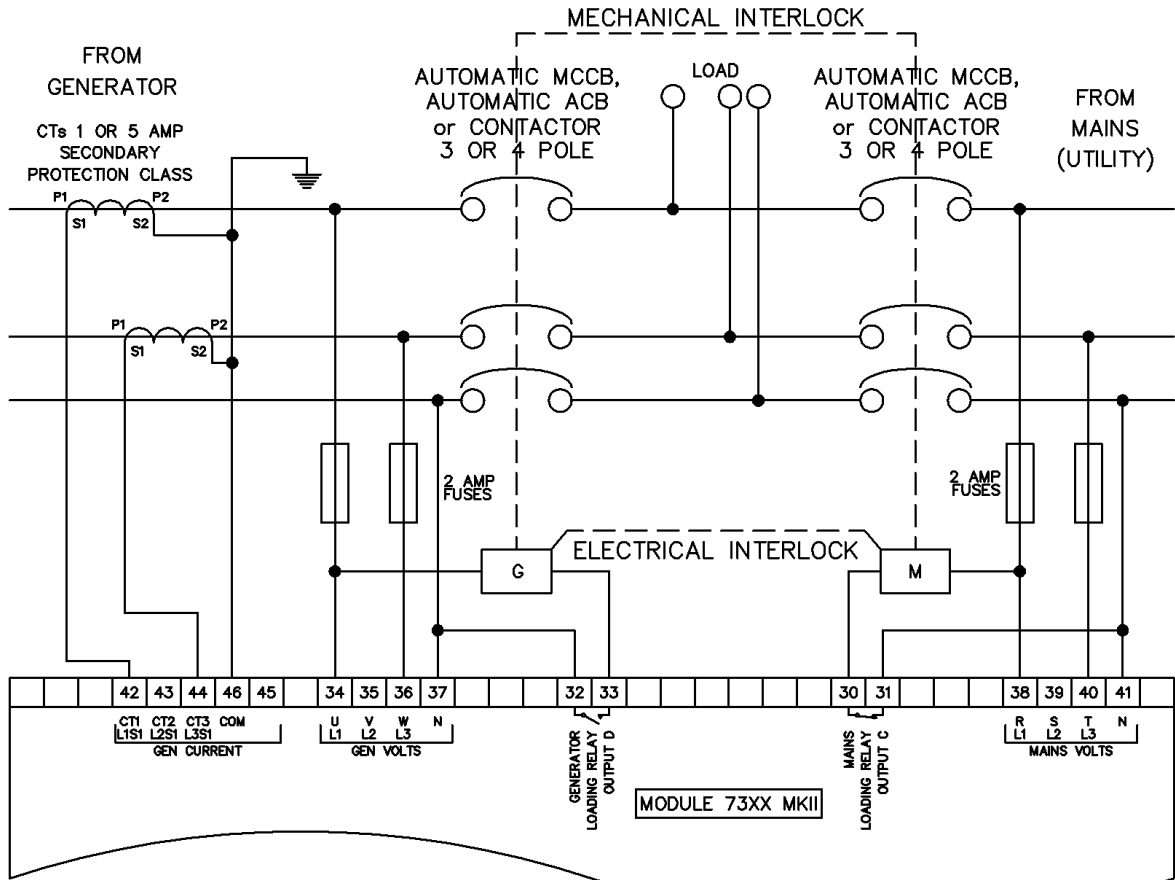

3.4.11 3 PHASE 3 WIRE DETLA WITHOUT EARTH FAULT

**NOTE:** The mains sensing terminals 38 to 41 are not fitted to the DSE7310 MKII.

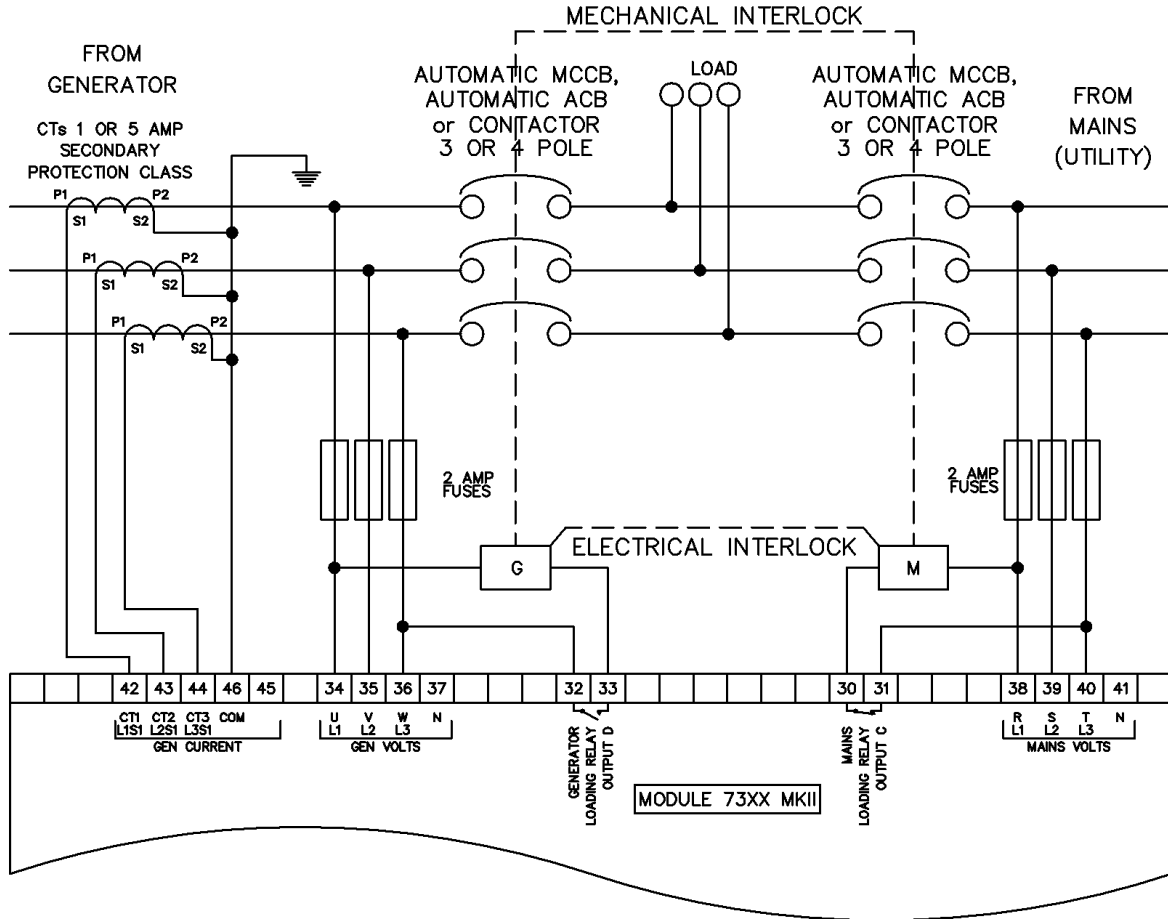

3.4.12 3 PHASE 4 WIRE WITHOUT EARTH FAULT

**NOTE:** The below diagram is applicable for the following AC topologies: 3 Phase 4 Wire Star, 3 Phase 4 Wire Delta L1-N-L2, 3 Phase 4 Wire Delta L1-N-L3 and 3 Phase 4 Wire Delta L2-N-L3. For further details of module configuration to suit these different topologies, refer to DSE Publication: 057-243 DSE7310 MKII & 7320 MKII Configuration Software Manual.

**NOTE:** The mains sensing terminals 38 to 41 are not fitted to the DSE7310 MKII.

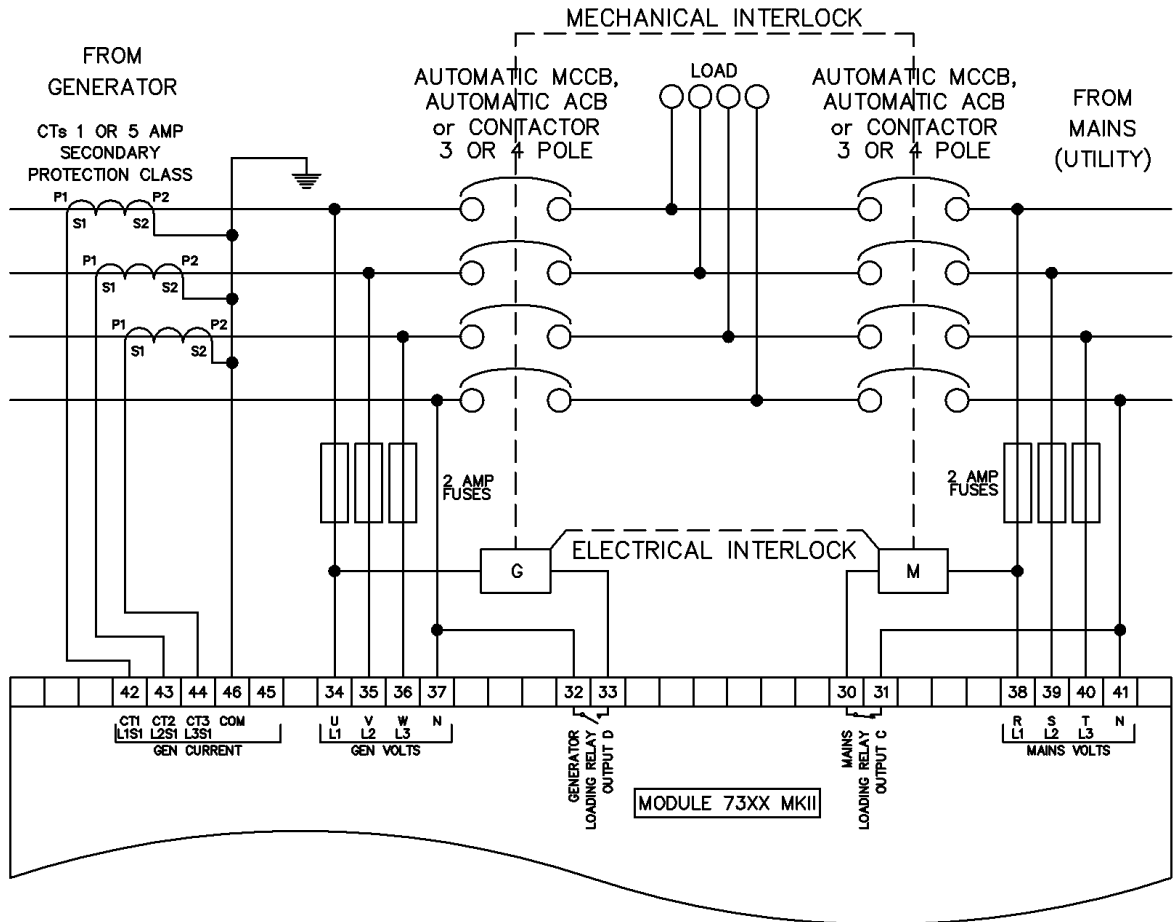

3.4.13 3 PHASE 4 WIRE WITH UNRESTRICTED EARTH FAULT

**NOTE:** The below diagram is applicable for the following AC topologies: 3 Phase 4 Wire Star, 3 Phase 4 Wire Delta L1-N-L2, 3 Phase 4 Wire Delta L1-N-L3 and 3 Phase 4 Wire Delta L2-N-L3. For further details of module configuration to suit these different topologies, refer to DSE Publication: 057-243 DSE7310 MKII & 7320 MKII Configuration Software Manual.

**NOTE:** The mains sensing terminals 38 to 41 are not fitted to the DSE7310 MKII.

This example shows the CTs in the neutral to earth link for a three phase four wire system to provide unrestricted earth fault protection, but the same philosophy is applicable to the other topologies.

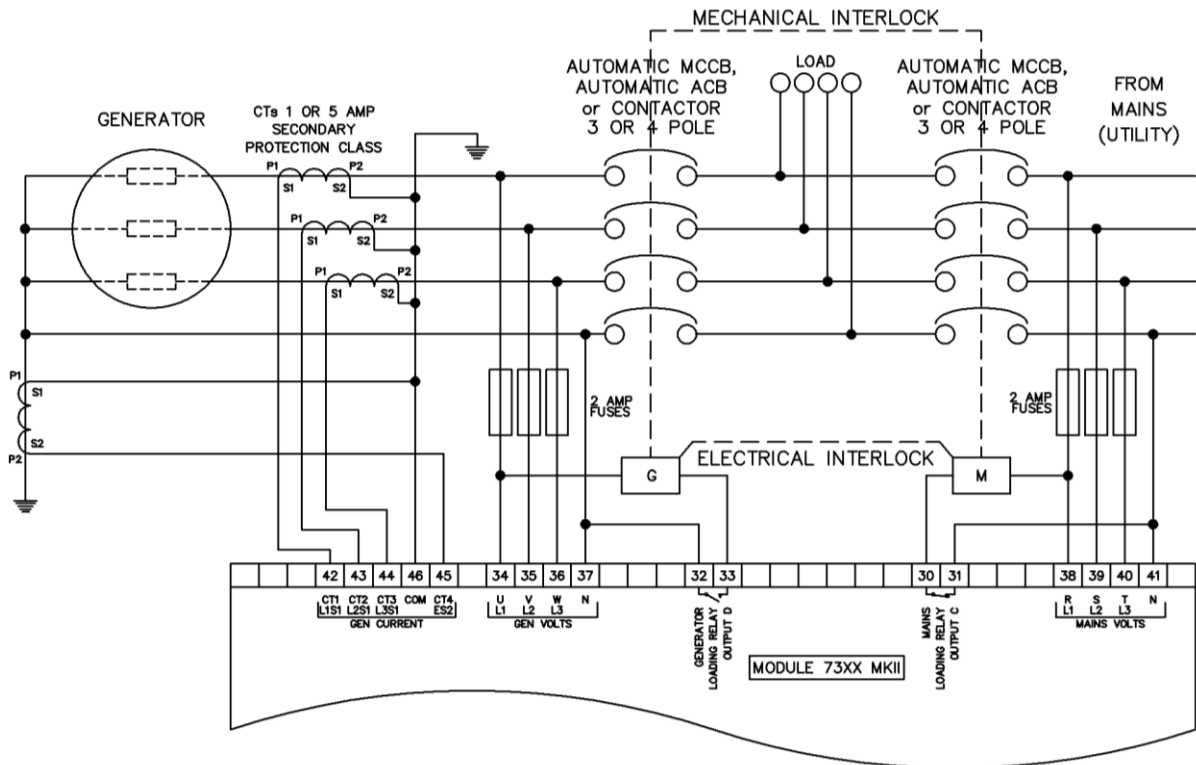

### 3.4.14 CT LOCATION

**NOTE:** CT Location is not applicable to DSE7310 MKII.

There are two possible locations for the current transformers to be installed in the system:

#### 3.4.14.1 GENERATOR

**NOTE:** Earthing the neutral conductor 'before' the neutral CT allows the module to read earth faults 'after' the CT only (Restricted to load / downstream of the CT)  
 Earthing the neutral conductor 'after' the neutral CT allows the module to read earth faults 'before' the CT only (Restricted to generator / upstream of the CT)

**NOTE:** The below diagram is applicable for the following AC topologies: 3 Phase 4 Wire Star, 3 Phase 4 Wire Delta L1-N-L2, 3 Phase 4 Wire Delta L1-N-L3 and 3 Phase 4 Wire Delta L2-N-L3. For further details of module configuration to suit these different topologies, refer to DSE Publication: 057-243 DSE7310 MKII & 7320 MKII Configuration Software Manual.

The CTs are used to measure and display generator current and power only. This example shows the CTs in the generator for a three phase four wire system with restricted earth fault protection, but the same philosophy is applicable to the other topologies.

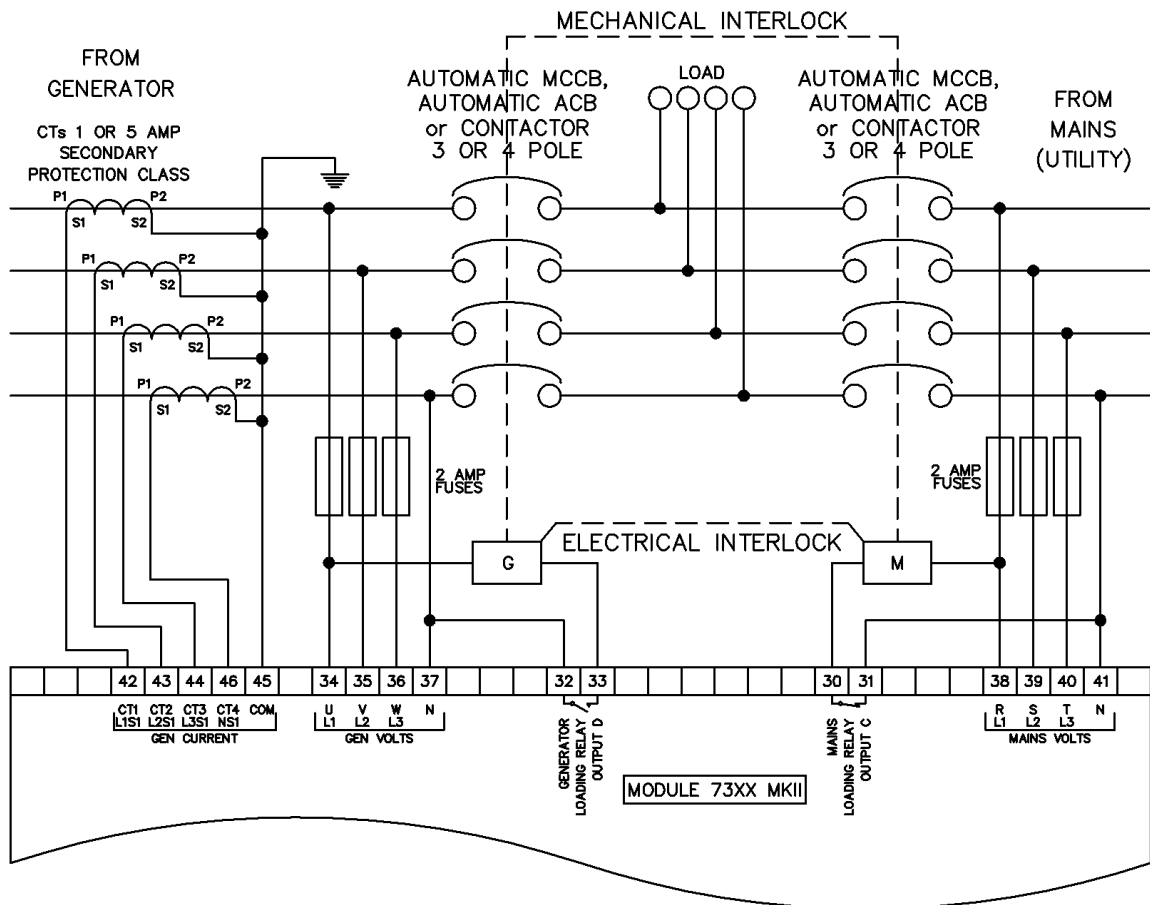

3.4.14.2 LOAD

**NOTE:** Earthing the neutral conductor 'before' the neutral CT allows the module to read earth faults 'after' the CT only (Restricted to load / downstream of the CT)  
 Earthing the neutral conductor 'after' the neutral CT allows the module to read earth faults 'before' the CT only (Restricted to generator / mains / upstream of the CT)

**NOTE:** The below diagram is applicable for the following AC topologies: 3 Phase 4 Wire Star, 3 Phase 4 Wire Delta L1-N-L2, 3 Phase 4 Wire Delta L1-N-L3 and 3 Phase 4 Wire Delta L2-N-L3. For further details of module configuration to suit these different topologies, refer to DSE Publication: 057-243 DSE7310 MKII & 7320 MKII Configuration Software Manual.

The CTs are used to measure and display generator current and power when the generator is on load and mains current and power when the mains is on load. The module display automatically changes to display the current and power in the relevant instrumentation page. This example shows the CTs in the 'load' for a three phase four wire system with restricted earth fault protection, but the same philosophy is applicable to the other topologies.

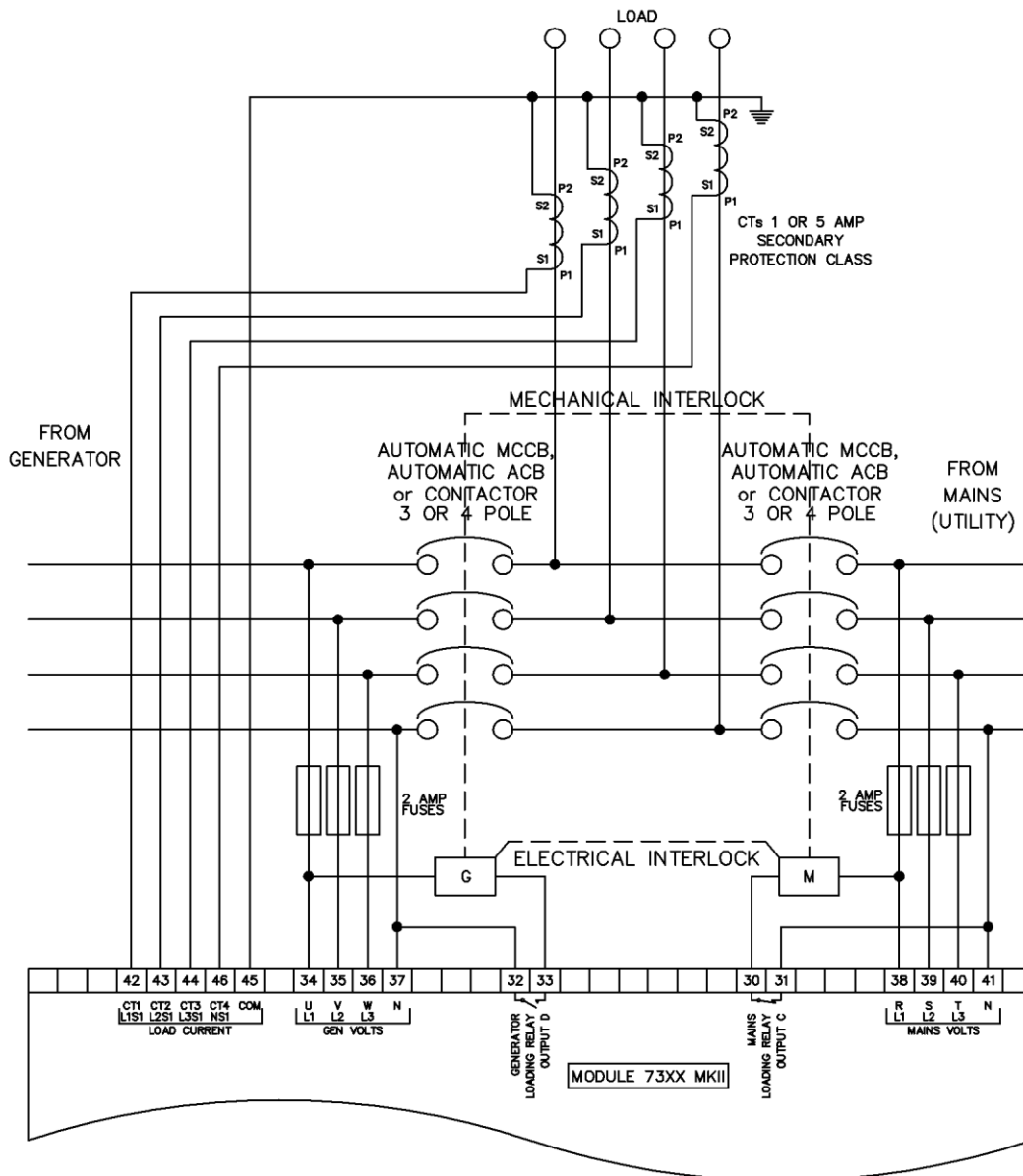



## 4 DESCRIPTION OF CONTROLS



**CAUTION:** The module may instruct an engine start event due to external influences. Therefore, it is possible for the engine to start at any time without warning. Prior to performing any maintenance on the system, it is recommended that steps are taken to remove the battery and isolate supplies.



**NOTE:** The following descriptions detail the sequences followed by a module containing the standard 'factory configuration'. Always refer to your configuration source for the exact sequences and timers observed by any particular module in the field.

Control of the module is via push buttons mounted on the front of the module with

**Stop/Reset Mode** , **Manual Mode** , **Test Mode**  (DSE7320 MKII Only), **Auto Mode** 

and **Start**  functions. For normal operation, these are the only controls which need to be operated. Details of their operation are provided later in this document.

### 4.1 DSE7310 MKII

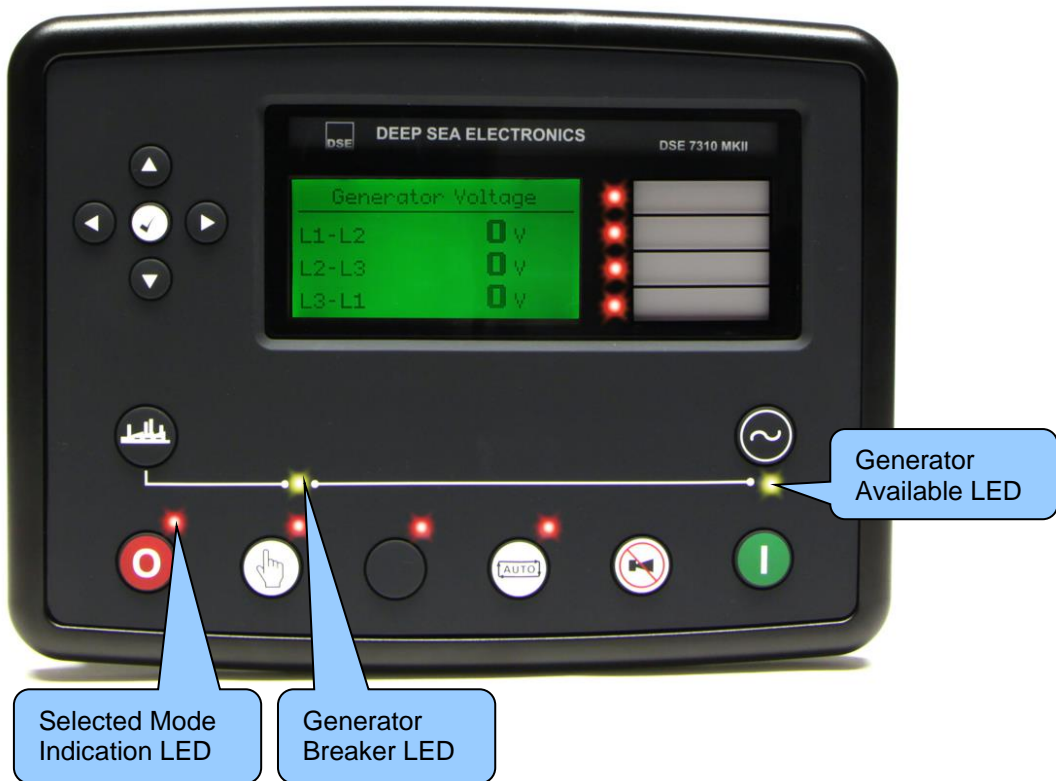
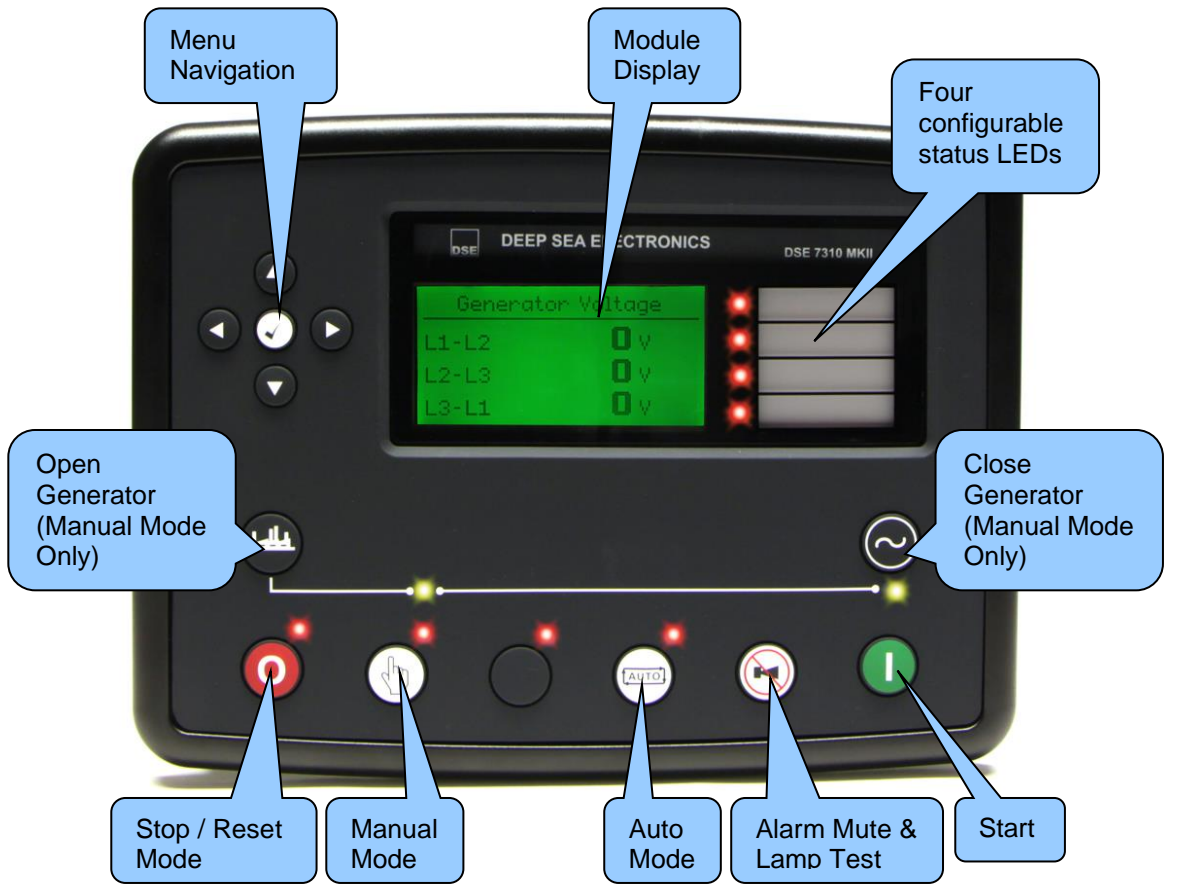



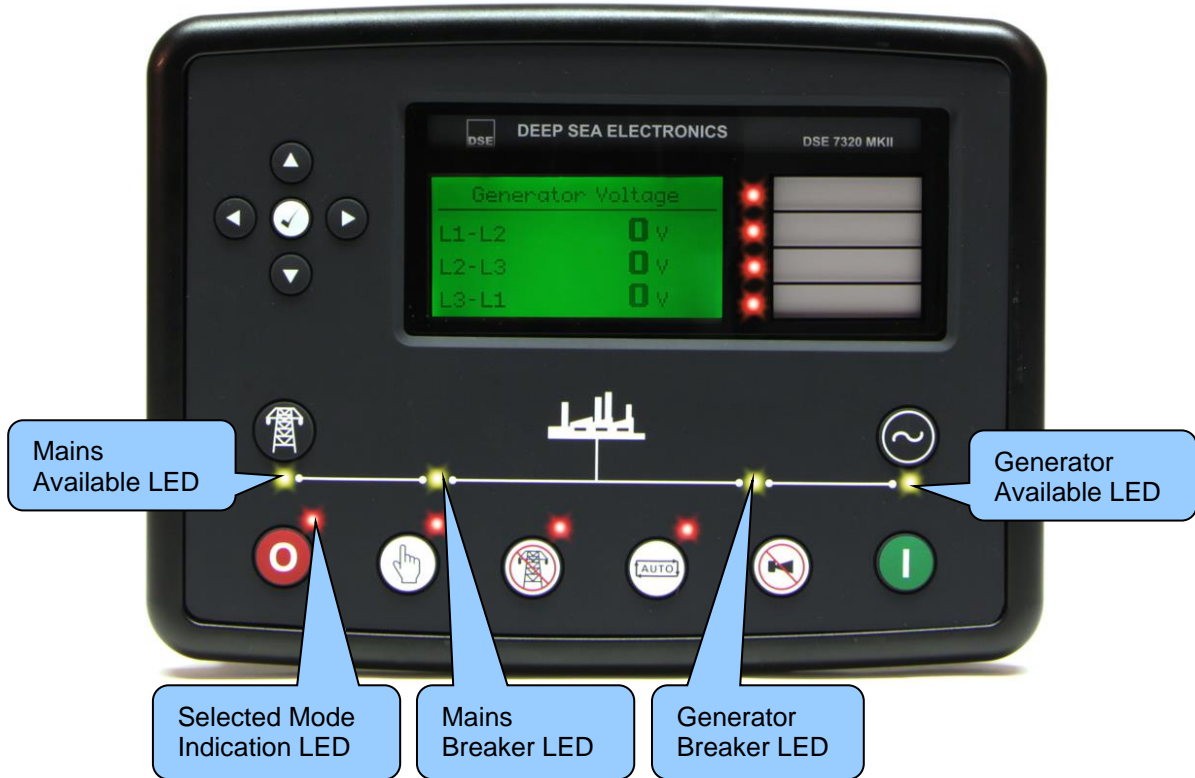
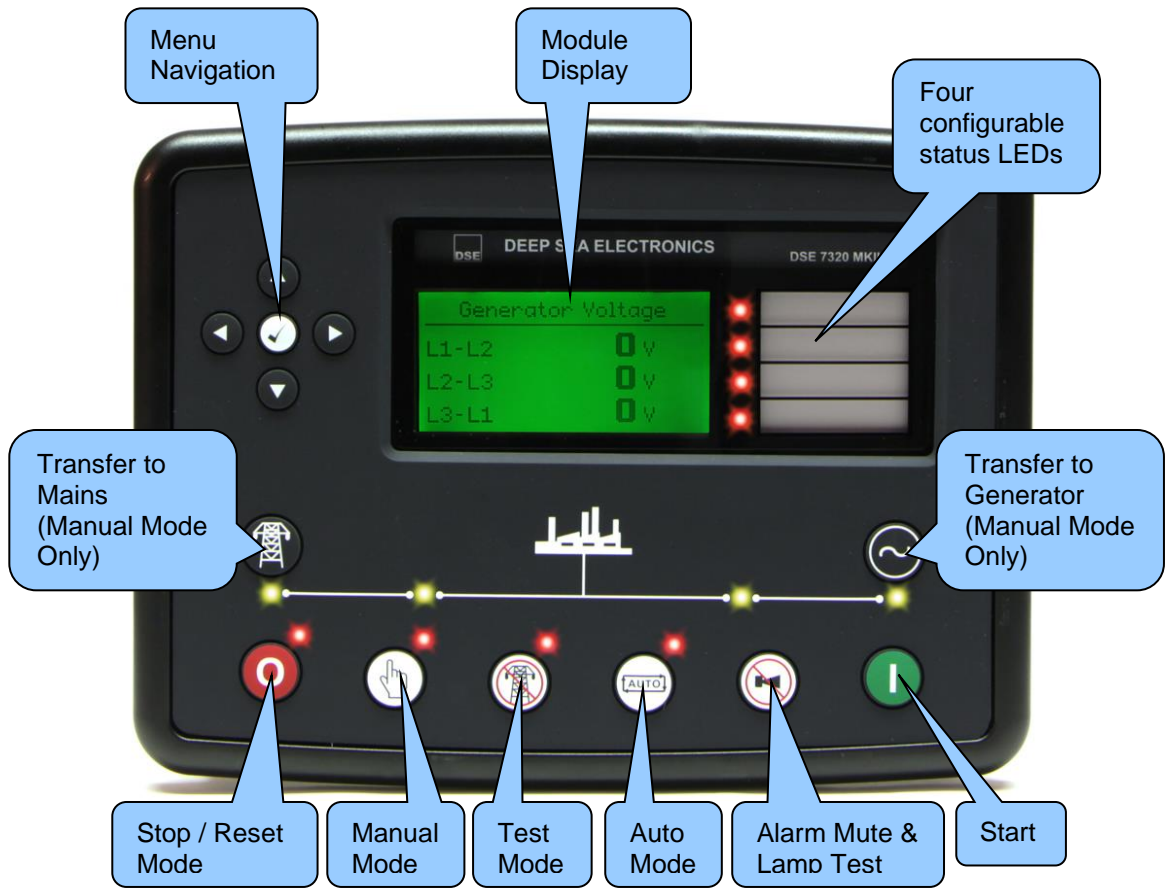

















### 4.2 DSE7320 MKII

















### 4.3 CONTROL PUSH BUTTONS



















 **NOTE:** For further details, see section 5 entitled *Operation* in this manual.

Icon	Description
	<p><b>Stop / Reset Mode</b></p> <p>This button places the module into its <b>Stop/Reset Mode</b> . This clears any alarm conditions for which the triggering criteria has been removed. If the engine is running and the module is put into <b>Stop/Reset Mode</b> , the module automatically instructs the generator off load (<b>'Close Generator Output' becomes inactive (if used on)</b>) and place the mains on load (<b>'Close Mains Output' becomes active (DSE7320 MKII)</b>). The fuel supply de-energises and the engine comes to a standstill. Should any form of <i>start signal</i> be present when in <b>Stop/Reset Mode</b>  the generator remains at rest</p>
	<p><b>Manual Mode</b></p> <p>This button places the module into its <b>Manual Mode</b> . Once in <b>Manual Mode</b> , the module responds to the <b>Start</b>  button to start the generator and run it off load.</p> <p>To place the generator on load, use the <b>Transfer to Generator</b>  button. The module automatically instructs the changeover device to take the mains off load (<b>'Close Mains Output' becomes inactive (if used on DSE7320 MKII)</b>) and place the generator on load (<b>'Close Generator Output' becomes active (if used)</b>). To place the generator off load, use the <b>Transfer to Mains</b>  or <b>Open Generator</b>  buttons. The module automatically instructs the changeover device to take the generator off load (<b>'Close Generator Output' becomes inactive (if used on)</b>) and place the mains on load (<b>'Close Mains Output' becomes active (DSE7320 MKII)</b>). Additional digital inputs can be assigned to perform these functions.</p> <p>If the engine is running off-load in <b>Manual Mode</b>  and on load signal becomes active, the module automatically instructs the changeover device the changeover device to take the mains off load (<b>'Close Mains Output' becomes inactive (if used on DSE7320 MKII)</b>) and place the generator on load (<b>'Close Generator Output' becomes active (if used)</b>). Upon removal of the on-load signal, the generator remains on load until either selection of the <b>Stop/Reset Mode</b>  or <b>Auto Mode</b> .</p>
	<p><b>Test Mode (DSE7320 MKII Only)</b></p> <p>This button places the module into its <b>Test Mode</b> . Once in <b>Test Mode</b> , the module responds to the <b>Start</b>  button to start the generator.</p> <p>Once the set has started and becomes available, it is automatically placed on load (Close Mains Output becomes inactive (if used on DSE7320 MKII) and Close Generator Output becomes active (if used)).</p> <p>The generator remains on load until either the <b>Stop/Reset Mode</b>  or <b>Auto Mode</b>  is selected.</p>

**NOTE:** For further details, see section 5 entitled *Operation* in this manual.

Icon	Description
	<p><b>Auto Mode</b></p> <p>This button places the module into its <b>Auto Mode</b> . This mode allows the module to control the function of the generator automatically. The module monitors numerous start requests and when one has been made, the set is automatically started. Once the generator is available, the mains is taken off load (<b>'Close Mains Output'</b> becomes inactive (if used on DSE7320 MKII)) and the generator is placed on load (<b>'Close Generator Output'</b> becomes active (if used)).</p> <p>Upon removal of the starting signal, the module starts the <i>Return Delay Timer</i> and once expired, takes the generator off load (<b>'Close Generator Output'</b> becomes inactive (if used on)), and place the mains on load (<b>'Close Mains Output'</b> becomes active (DSE7320 MKII)). The generator then continues to run for the duration of the <i>Cooling Timer</i> until it stops. The module then waits for the next start event.</p>
	<p><b>Alarm Mute / Lamp Test</b></p> <p>This button silences the audible alarm in the controller, de-activates the <i>Audible Alarm</i> output (if configured) and illuminates all the LEDs on the module's fascia as a lamp test function.</p>
	<p><b>Start</b></p> <p>This button is only active in the <b>Stop/Reset Mode</b> , <b>Manual Mode</b>  and Test Mode .</p> <p>Pressing the <b>Start</b>  button in <b>Stop/Reset Mode</b>  powers up the engine's ECU but does not start the engine. This can be used to check the status of the CAN communication and to prime the fuel system.</p> <p>Pressing the <b>Start</b>  button in <b>Manual Mode</b>  or <b>Test Mode</b>  starts the generator and runs it off load in <b>Manual Mode</b>  or on load in <b>Test Mode</b> .</p>
	<p><b>Menu Navigation</b></p> <p>Used for navigating the instrumentation, event log and configuration screens.</p>

 **NOTE:** For further details, see section 5 entitled *Operation* in this manual.

Icon	Description
	<p><b>Transfer To Generator</b></p> <p>The <b>Transfer to Generator</b>  button controls the operation of the generator load switch is only active in the <b>Manual Mode</b>  once the generator is available.</p> <p><b>‘Normal’ Breaker Button Control</b></p> <p>Pressing the <b>Transfer to Generator</b>  button when the Generator is available and off load, the Mains load switch is opened (<b>‘Close Mains’ becomes inactive</b>) and the Generator load switch is closed (<b>‘Close Generator’ becomes active</b>).</p> <p>Further presses of the <b>Transfer to Generator</b>  button have no effect.</p> <p><b>‘Alternative’ Breaker Button Control</b></p> <p>Pressing the <b>Transfer to Generator</b>  button when the Generator is available and off load, the Mains load switch is opened (<b>‘Close Mains’ becomes inactive</b>) and the Generator load switch is closed (<b>‘Close Generator’ becomes active</b>).</p> <p>Further presses of the <b>Transfer to Generator</b>  button opens and closes the Generator load switch (<b>‘Close Generator’ changes state</b>) and leaves the Mains load switch in the open position (<b>‘Close Mains’ remains inactive</b>).</p>
	<p><b>Open Generator (DSE7310 MKII Only)</b></p> <p>The <b>Open Generator</b>  button is only active in the <b>Manual Mode</b>  and allows the operator to open the generator load switch. Pressing the <b>Open Generator</b>  button when the Generator is on load, the generator load switch is opened (<b>‘Close Generator’ becomes inactive</b>). Further presses of the <b>Open Generator</b>  button have no effect.</p>
	<p><b>Transfer To Mains (DSE7320 MKII Only)</b></p> <p>The <b>Transfer to Mains</b>  button controls the operation of the mains load switch and is only active in <b>Manual Mode</b> .</p> <p><b>‘Normal’ Breaker Button Control</b></p> <p>Pressing the <b>Transfer to Mains</b>  button when the Mains is available and off load, the generator switch is opened (<b>‘Close Generator’ becomes inactive</b>) and the mains switch is closed (<b>‘Close Mains’ becomes active</b>). Further presses of the <b>Transfer to Mains</b>  button have no effect.</p> <p><b>‘Alternative’ Breaker Button Control</b></p> <p>Pressing the <b>Transfer to Mains</b>  button when the Mains is available and off load, the generator load switch is opened (<b>‘Close Generator’ becomes inactive</b>) and the mains load switch is closed (<b>‘Close Mains’ becomes active</b>). Further presses of the <b>Transfer to Mains</b>  button opens and closes the mains load switch (<b>‘Close Mains’ changes state</b>) and leaves the generator load switch in the open position (<b>‘Close Generator’ remains inactive</b>).</p>

## 4.4 VIEWING THE INSTRUMENT PAGES

**NOTE:** Depending upon the module's configuration, some display screens, or specific instrumentation may be disabled. For further details of module configuration, refer to DSE Publication: 057-243 *DSE7310 MKII & DSE7320 MKII Configuration Software Manual*.



It is possible to scroll to display the different pages of information by repeatedly operating the

**Next & Previous Page**  buttons.

Example

If you want to view one of the instrument pages towards the end of the list, it may be quicker to scroll left through the pages rather than right!

And so on until the desired page is reached. Further presses of the **Next Page Button**  returns the Status page.

**Status**  **Generator**  **Mains** 

The complete order and contents of each information page are given in the following sections

Once selected, the page remains on the LCD display until the user selects a different page, or after an extended period of inactivity (*LCD Page Timer*), the module reverts to the status display.

If no buttons are pressed upon entering an instrumentation page, the instruments displayed are automatically subject to the setting of the *LCD Scroll Timer*.

The *LCD Page* and *LCD Scroll* timers are configurable using the DSE Configuration Suite Software or by using the Front Panel Editor.

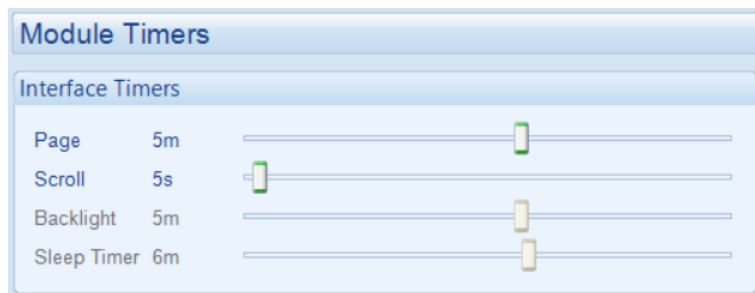

The screenshot shows the factory settings for the timers, taken from the DSE Configuration Suite PC Software.

Alternatively, to scroll manually through all instruments on the currently selected page, press the

**Instrumentation Scroll**  buttons. The 'auto scroll' is disabled.

To re-enable 'auto scroll' press the **Instrumentation Scroll**  buttons to scroll to the 'title' of the instrumentation page (ie Mains). A short time later (the duration of the *LCD Scroll Timer*), the instrumentation display begins to auto scroll.

When scrolling manually, the display automatically returns to the Status page if no buttons are pressed for the duration of the configurable *LCD Page Timer*.

If an alarm becomes active while viewing the status page, the display shows the Alarms page to draw the operator's attention to the alarm condition.

#### 4.4.1 STATUS

 **NOTE:** Press the *Instrumentation Scroll*  buttons on the *Status Page* to view other Configurable Status Screens if configured. For further details of module configuration, refer to DSE Publication: 057-243 *DSE7310 MKII & DSE7320 MKII Configuration Software Manual*.

This is the 'home' page, the page that is displayed when no other page has been selected, and the page that is automatically displayed after a period of inactivity (*LCD Page Timer*) of the module control buttons.

This page changes with the action of the controller for example when the generator is running and available:

<b>Status</b>	<b>22:31</b>	Factory setting of <i>Status</i> screen showing engine stopped...
<b>Generator at Rest</b>		
<b>Stop Mode</b>		

<b>Status</b>	<b>22:31</b>	...and engine running
<b>Generator Available</b>		

##### 4.4.1.1 GENERATOR LOCKED OUT

<b>Status</b>	<b>22:31</b>	<i>Generator Locked Out</i> indicates that the Generator cannot be started due to an active <i>Shutdown</i> or <i>Electrical Trip Alarm</i> on the module. Press the <b>Next or Previous Page</b>  button to scroll
<b>Generator Locked Out</b>		

to the alarms page to investigate. Press the **Stop/Reset Mode**  button to clear the alarm, if the alarm does not clear the fault is still active.

##### 4.4.1.2 WAITING FOR GENERATOR

 **NOTE:** For further details of module configuration, refer to DSE Publication: 057-243 *DSE7310 MKII & DSE7320 MKII Configuration Software Manual*.

<b>Status</b>	<b>22:31</b>	<i>Waiting For Generator</i> indicates that the Generator has started but has not reached the required <i>Loading Voltage</i> and or <i>Loading Frequency</i> as set in the module's configuration. Press the
<b>Waiting For Generator</b>		

**Next or Previous Page**  buttons to scroll to the *Generator* page to check to see if the generator voltage and frequency is higher than the configured *Loading Voltage* and *Loading Frequency*.



4.4.1.3 CONFIGURABLE STATUS SCREENS

**NOTE:** For further details of module configuration, refer to DSE Publication: *057-243 DSE7310 MKII & DSE7320 MKII Configuration Software Manual.*

The contents of the Home Page may vary depending upon configuration by the generator manufacturer or supplier. Below is an example of the Home Page being changed to show engine CAN related information.

The configured status pages are displayed as the Home Page

Example of EPA icons being selected to be the default Home Page.

Other pages can be configured to be shown, automatically scrolling when the set is running.

**EPA Home Screen Example:**

**NOTE:** The EPA Icons is only available as a *Configurable Status Screen*.

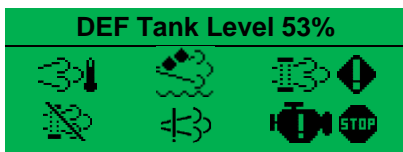

For further information about the default icons, refer to the *Engine* section 4.4.2 in this manual. Depending upon module configuration, the icons displayed, and their functions may differ from the default. An example of icon configuration is shown:

#### 4.4.2 ENGINE

 **NOTE\***: For further details of supported engines, refer to DSE Publication: *057-004 Electronic Engines and DSE Wiring Guide*.

These pages contain instrumentation gathered about the engine measured or derived from the module's inputs, some of which may be obtained from the engine ECU.

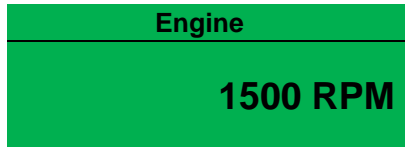

Engine Speed  
Oil Pressure  
Coolant Temperature  
Engine Battery Volts  
Engine Run Time  
Engine Fuel Level  
Oil Temperature\*  
Coolant Pressure\*  
Inlet Temperature\*  
Exhaust Temperature\*  
Fuel Temperature\*  
Turbo Pressure\*  
Fuel Pressure\*  
After Treatment Fuel Used\*  
After Treatment Exhaust Gas Temperature\*  
Engine Reference Torque\*  
Engine Percentage Torque\*  
Engine Demand Torque\*  
Engine Percentage Load\*  
Accelerator Pedal Position\*  
Nominal Friction Torque\*  
Engine Oil Level\*  
Engine Crank Case Pressure\*  
Engine Coolant Level\*  
Engine Injector Rail Pressure\*  
EGR Flow Rate\*  
Pre Filter Oil Pressure\*  
Instant Brake Power (kW) \*  
Exhaust Gas Temperature\*  
Turbo Oil Temperature\*  
ECU Temperature\*  
Cooling Fan Speed\*  
Engine Total Revolutions\*  
Atmospheric Pressure\*  
Water In Fuel\*  
Air Inlet Pressure\*  
Air Filter Differential Pressure\*



Continued over page...

*Description of Controls*

Particulate Trap Pressure\*  
Manifold Pressure\*  
Intercooler Level\*  
Electrical Potential\*  
Electrical Current\*  
PGI Information\*  
ECM Operation\*  
DPF Regeneration\*  
DPF Regeneration Lamps\*  
DPF Soot and Ash Load\*  
Pre-heat Status\*  
Engine Rated Power\*  
Engine Rated Speed\*  
Idle Speed\*  
Desired Operation Speed\*  
DEF Tank Level\*  
DEF Tank Temperature\*  
DEF Level Status\*  
DEF Reagent Consumption\*  
SCR After Treatment Status\*  
SCR-DEF Lamps\*  
SCR Action Timer\*  
EGR Pressure\*  
EGR Temperature\*  
Ambient Air Temperature\*  
Air Intake Temperature\*  
ECM Name\*  
ECM Number\*  
ECU Shutdown Status\*  
ECU Lamps ext\*  
ECU Lamps\*  
CAN Bus Information\*  
Fuel Consumption\*  
Fuel Used\*  
Flexible Sensors\*  
Engine Maintenance Alarm 1\*  
Engine Maintenance Alarm 2\*  
Engine Maintenance Alarm 3\*  
Engine Exhaust Temperature\*  
Intercooler Temperature\*  
Turbo Oil Pressure\*  
Fan Speed\*  
ECU Regeneration\*  
ECU Regeneration Icons\*  
Engine Soot Levels\*  
ECU ECR DEF Icons\*  
DEF Counter Minimum\*  
DPF Filter Status\*  
DPF Regen Inhibit\*  
DPF Regen Inhibit ET\*  
Torque Mode\*  
Instant Fuel Rate\*  
Gas Fuel Pressure\*  
Throttle Position\*  
Engine ECU Link\*  
Tier 4 Engine Information\*  
Escape Mode\*

#### 4.4.2.1 MANUAL FUEL PUMP CONTROL

**NOTE:** For further details of module configuration, refer to DSE Publication: *057-243 DSE7310 MKII & DSE7320 MKII Configuration Software Manual*.

Depending upon module configuration, the *Fuel Level* page may include a **Tick**  icon. This denotes that *Manual Fuel Pump Control* is available by pressing and holding the **Tick**  button.

**Example:**

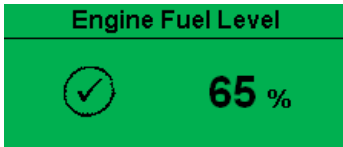

4.4.2.2 DPF REGENERATION LAMPS

**NOTE:** For further details of module configuration, refer to DSE Publication: **057-243 DSE7310 MKII & DSE7320 MKII Configuration Software Manual.**

Depending upon the *Engine Type* selected in the module's configuration, the *Engine* section may include the *DPF Regeneration Lamps* page. This page contains icons to show the status of various ECU functions, some of which are applicable to Tier 4 engine requirements. The icons flash at different rates to show the status of the ECU function, refer to the engine manufacturer for more information about this.

Icon	Fault	Description
	<b>ECU Amber Alarm</b>	The module received an Amber fault condition from the engine ECU.
	<b>ECU Red Alarm</b>	The module received a Red fault condition from the engine ECU.
	<b>DPF Active</b>	The module received a fault indication from the engine ECU informing that the <i>Diesel Particulate Filter</i> is active.
	<b>DPF Warning</b>	The module received a fault condition from the engine ECU informing that the <i>Diesel Particulate Filter</i> has a fault condition.
	<b>DPF Stop</b>	The module received a fault indication from the engine ECU informing that the <i>Diesel Particulate Filter</i> has been stopped.
	<b>DPF Inhibited</b>	The module received a fault indication from the engine ECU informing that the <i>Diesel Particulate Filter</i> has been inhibited.
	<b>HEST Active</b>	The module received a fault indication from the engine ECU informing that the <i>High Exhaust System Temperature</i> is active.
	<b>DEF Low Level</b>	The module received a fault condition from the engine ECU informing that the <i>Diesel Exhaust Fluid Low Level</i> is active.
	<b>SCR Inducement</b>	The module received a fault indication from the engine ECU informing that the <i>Selective Catalytic Reduction Inducement</i> is active.

Example:

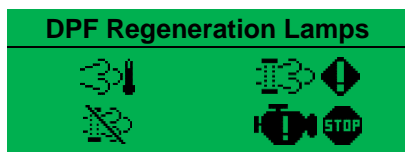

## Description of Controls

Depending upon module configuration, the icons displayed, and their functions may differ from the default as documented above. An example of icon configuration is shown:

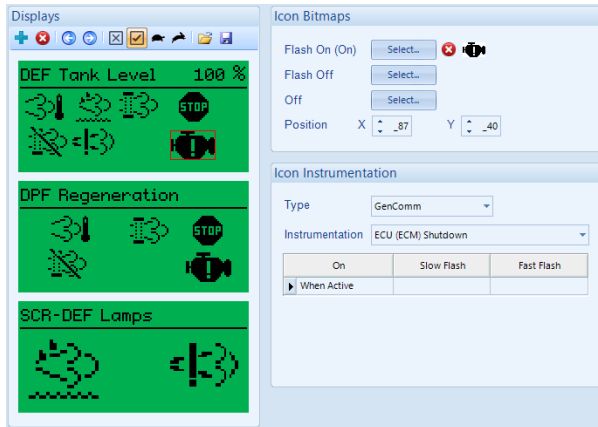

### 4.4.3 GENERATOR

Contains electrical values of the mains (utility), measured, or derived from the module's voltage and current inputs.

Press the **Instrumentation Scroll**  buttons scroll through the **Generator** parameters.

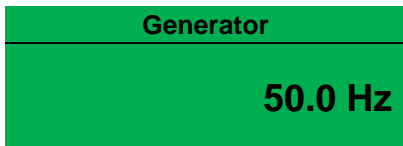

- Generator Voltage (ph-N)
- Generator Voltage (ph-ph)
- Generator Frequency
- Generator Current (A)
- Generator Load ph-N (kW)
- Generator Total Load (kW)
- Generator Load ph-N (kVA)
- Generator Total Load (kVA)
- Generator Single Phase Power Factors
- Generator Power Factor Average
- Generator Load ph-N (kvar)
- Generator Total Load (kvar)
- Generator Accumulated Load (kWh, kVAh, kvarh)
- Generator Loading Scheme
- Generator Phase Rotation
- Generator Nominal
- Generator Active Configuration

4.4.3.1 SYNCHROSCOPE (DSE7320 MKII ONLY)

**NOTE:** The *Synchroscope* and associated operation is only available when *Check Sync* has been enabled in the module's configuration. For further details of module configuration, refer to DSE Publication: 057-243 *DSE7310 MKII & DSE7320 MKII Configuration Software Manual*.

**NOTE:** If the module display is showing the status page when the synchronising process begins, the module automatically switches to the *Synchroscope* page.

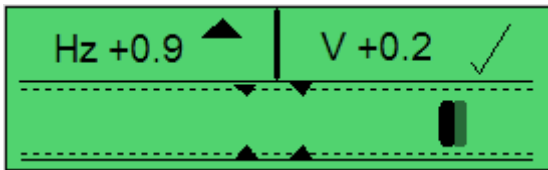

Initially the synchroscope display shows the difference between the bus and generator supplies. Here the display is showing a frequency mismatch of +0.9 Hz and a voltage mismatch of +0.2 V. The genset frequency is too high (indicated by the arrow) and must be reduced. The voltage is high but is within the check sync limits set for synchronising (indicated by the tick).

In most cases, the DSE module then waits for the frequency, voltage, and phase to drift into synchronism.

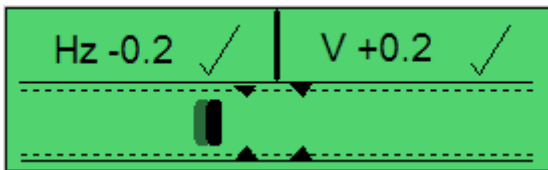

If the DSE module is configured to do so, it actively controls the synchronising using a CANbus engine and CANbus AVR. The module first matches the frequency and voltage and when they are within acceptable limits, the phase matching begins as indicated by the moving bar which shows the phase difference between the two supplies. The engine speed is automatically adjusted, altering the phase, until the moving bar enters the centre of the scope.

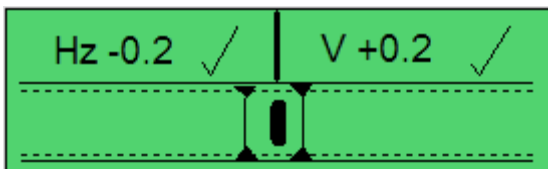

Once the supplies are in sync, the module initiates a breaker close signal placing the two supplies in parallel. If synchronism is broken or not achieved, the moving bar passes out of the synchronising window.

#### 4.4.4 MAINS (DSE7320 MKII ONLY)

**NOTE\***: Mains current and powering monitoring is only available when the CTs are configured for and placed in the load. For further details of module configuration, refer to DSE Publication: 057-243 *DSE7310 MKII & DSE7320 MKII Configuration Software Manual*.

Contains electrical values of the mains (utility), measured, or derived from the module's voltage and current inputs.



Press the **Instrumentation Scroll** buttons scroll through the **Mains** parameters.

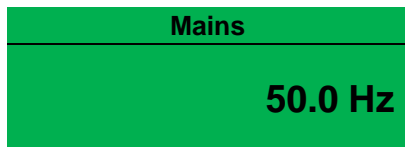

- Mains Voltage (ph-N)
- Mains Voltage (ph-ph)
- Mains Frequency
- Mains Current (A)\*
- Mains Phase Rotation
- Mains Active Configuration
- Mains Load ph-N (kW)\*
- Mains Total Load (kW)\*
- Mains Load ph-N (kVA)\*
- Mains Total Load (kVA)\*
- Mains Single Phase Power Factors\*
- Mains Average Power Factor\*
- Mains Load ph-N (kvar)\*
- Mains Total Load (kvar)\*
- Mains Accumulated Load (kWh, kVAh, kvarh)\*



#### 4.4.5 EXPANSION

Contains measured values from various input expansion modules that are connected to the DSE module.



Press the **Instrumentation Scroll** buttons scroll through the **Expansion** parameters if configured.

Oil Temperature
80 °C
176 °F

- DSE2130 Analogue Inputs (Only appears if configured)
- DSE2131 Analogue Inputs (Only appears if configured)
- DSE2133 RTD / Thermocouple Inputs (Only appears if configured)

### 4.4.5.1 CHARGER

Contains the information and instrumentation of the DSE Intelligent Battery Chargers that are connected to the DSE controller.

Press the **Instrumentation Scroll**  buttons scroll through the **Charger** parameters if configured.

Charger ID1	
Device	94xx V1.1.1
USB ID	1E1F21EA

Shows the ID number configured in the DSE module's Expansion

Information screen of the charger connected to the DSE module (battery charger model number, version, and its USB ID).

Supply Voltage	
L1 - N	240V

Supply Instrumentation Screen.

Charger ID1	
Temperature	32 °C 89 °F

Battery charger temperature instrumentation screen.

Charger ID1	
Fan 1	100 rpm
Fan 2	0 rpm

Battery charger fans speed when supported by the charger.

Charger Output 1	
Charge Mode	Float

Output Instrumentation screens. Showing Output 1 of the battery charger.

Showing the charge mode (Boost, Absorption, Float, or Storage)

Charger Output 1	
Output	26.91V

... Output voltage

Charger Output 1	
Current	7.05A
Limit	10.00A
Power	189W

...Output current, limit, and power

#### 4.4.6 ALARMS

When an alarm is active, the *Internal Audible Alarm* sounds and the Common Alarm LED, if configured, illuminates.

The audible alarm is silenced by pressing the **Alarm Mute / Lamp Test**  button.

The LCD display jumps from the 'Information page' to display the Alarm Page

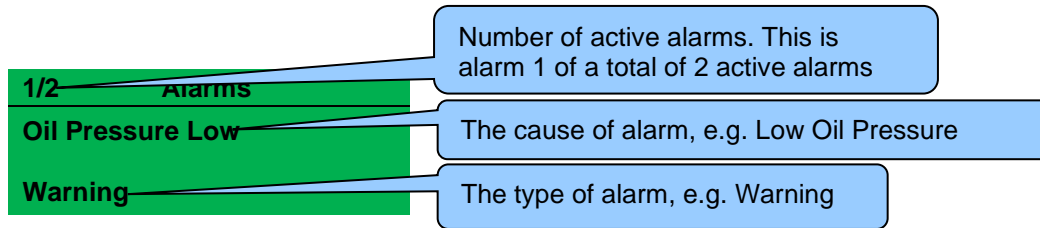

The LCD displays multiple alarms such as "*Coolant Temperature High*", "*Emergency Stop*" and "*Low Coolant Warning*". These automatically scroll in the order that they occurred or press the

 **Instrumentation Scroll** buttons scroll through manually.

In the event of an alarm, the LCD displays the appropriate text. If an additional alarm then occurs, the module displays the appropriate text.

#### Example:

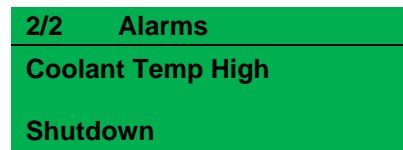
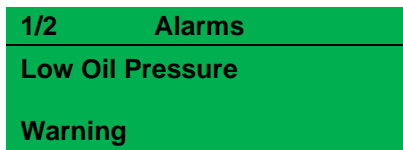

4.4.6.1 ECU ALARMS (CAN FAULT CODES / DTC)

 **NOTE:** For details on these code/graphic meanings, refer to the ECU instructions provided by the engine manufacturer, or contact the engine manufacturer for further assistance.

 **NOTE:** For further details on connection to electronic engines, refer to DSE Publication: *057-004 Electronic Engines And DSE Wiring*

When connected to a suitable CAN engine, the controller displays alarm status messages from the ECU in the *Alarms* section of the display.

1/1	Alarms
ECU Amber	
Warning	

Type of alarm that is triggered on the DSE module, e.g. Warning

Press the **Next Page**  button to access the list of *Current Engine DTCs* (Diagnostic Trouble Codes) from the ECU which are DM1 messages.

1/2	ECU Current DTCs
Water Level Low	
SPN=131166 , FMI=8, OC=127	

The DM1 DTC is interpreted by the module and is shown on the module's display as a text message. In addition to this, the manufacturer's DTC is shown below.

Press the **Next Page**  button to access the list of *ECU Prev. DTCs* (Diagnostic Trouble Codes) from the ECU which are DM2 messages.

1/10	ECU Prev. DTCs
Water Level Low	
SPN=131166 , FMI=8, OC=127	

The DM2 DTC is interpreted by the module and is shown on the module's display as a text message. In addition to this, the manufacturer's DTC is shown below.

### 4.4.7 EVENT LOG

**NOTE:** For further details of module configuration, refer to DSE Publication: **057-243 DSE7310 MKII & DSE7320 MKII Configuration Software Manual.**

The module maintains a log of past alarms and/or selected status changes. The log size has been increased in the module over past module updates and is always subject to change. At the time of writing, the modules log can store the last 250 log entries.

Under default factory settings, the event log is configured to include all possible options; however, this is configurable by the system designer using the DSE Configuration Suite software.





Example showing the possible configuration of the event log (DSE Configuration Suite Software).

This also shows the factory settings of the module.

When the event log is full, any subsequent event overwrites the oldest entry. Hence, the event log always contains the most recent events. The module logs the event type, along with the date and time (or engine running hours if configured to do so).

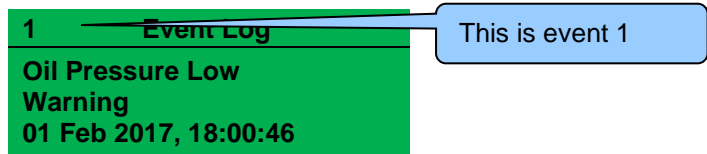
To view the event log, repeatedly press the **Next or Previous Page**  buttons until the LCD screen displays the *Event Log* page.



Press the **Scroll Down**  button to view the next most recent event.

Continuing to press the **Scroll Down**  button cycles through the past events after which, the display shows the most recent alarm, and the cycle begins again.

To exit the event log and return to viewing the instruments, press the **Next or Previous Page**  buttons to select the next instrumentation page.

#### 4.4.8 SERIAL PORT

##### 4.4.8.1 RS232 SERIAL PORT

This section is included to give information about the RS232 serial port and external modem (if connected).

The items displayed on this page change depending upon configuration of the module. Refer to the system supplier for further details.

**NOTE: Factory Default settings are for the RS232 port to be enabled with no modem connected, operating at 19200 baud, MODBUS slave address 10.**

#### Connected To an RS232 Telephone Modem

When the module is powered up, it sends 'initialisation strings' to the connected modem. It is important therefore that the modem is already powered or is powered up at the same time as the module. At regular intervals after power up, the modem is reset, and reinitialised, to ensure the modem does not 'hang up'.

If the module does not correctly communicate with the modem, "Modem initialising" appears on the Serial Port instrument screen as shown overleaf.

If the module is set for "incoming calls" or for "incoming and outgoing calls", once the modem is dialled, it answers after two rings (using the factory setting 'initialisation strings'). Once the call is established, all data is passed between the dialling PC and the module.

If the module is set for "outgoing calls" or for "incoming and outgoing calls", then the module dials out whenever an alarm is generated.

**NOTE: Not all alarms generate a dial out command; this is dependent upon module configuration of the event log. Any event configured to be recorded in the event log causes the modem to dial out to a PC.**

The screenshot shows a green background with the following text:

Serial Port	
Baud	9600
SlaveID	10
Modem	

Two callouts are present:

- A blue callout pointing to the 'Modem' field: "Indicates that the RS232 port is configured for modem use. It displays 'RS232' if no modem is configured."
- A blue callout pointing to the right side of the screen: "Press the **Scroll Down** button view the modem status...." (The button is represented by a small icon with four arrows pointing up, down, left, and right).

### **Connected to an RS232 GSM Modem**

When the module is powered up, it sends 'initialisation strings' to the connected modem. It is important therefore that the modem is already powered or is powered up at the same time as the module. At regular intervals after power up, the modem is reset, and reinitialised, to ensure the modem does not 'hang up'.

If the module does not correctly communicate with the modem, "Modem initialising" appears on the Serial Port instrument screen as shown overleaf.

If the module is set for "incoming calls" or for "incoming and outgoing calls", once the modem is dialled, it answers after two rings (using the factory setting 'initialisation strings'). Once the call is established, all data is passed between the dialling PC and the module.

If the module is set for "outgoing calls" or for "incoming and outgoing calls", then the module dials out whenever an alarm is generated.

**NOTE: Not all alarms generate a dial out command; this is dependent upon module configuration of the event log. Any event configured to be recorded in the event log causes the modem to dial out to a PC.**

Many GSM modems are fitted with a status LED to show operator cell status and ringing indicator. These are a useful troubleshooting tool.

In the case of GSM connection problems, try calling the DATA number of the SIMCARD with an ordinary telephone. There should be two rings, followed by the modem answering the call and then 'squealing'. If this does not happen, check all modem connections, and double check with the SIM provider that it is a DATA SIM and can operate as a data modem. DATA is NOT the same as FAX or GPRS and is often called Circuit Switched Data (CSD) by the SIM provider.

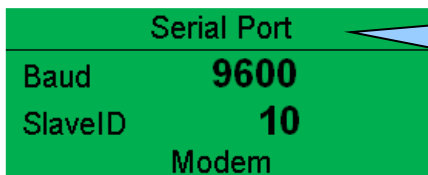

Press the **Scroll Down**  button view the modem GSM status....

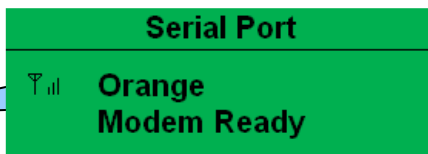

**NOTE: In the case of GSM modems, it is important that a DATA ENABLED SIM is used. This is often a different number than the 'voice number' and is often called Circuit Switched Data (CSD) by the SIM provider.**

If the GSM modem is not purchased from DSE, ensure that it has been correctly set to operate at 9600 baud.

**Modem Initialisation Sequence**

The modem attempts to communicate to the module

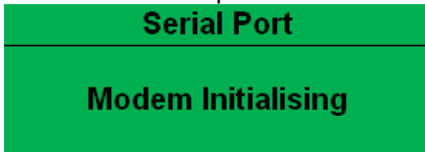

If the Modem and module communicate successfully:

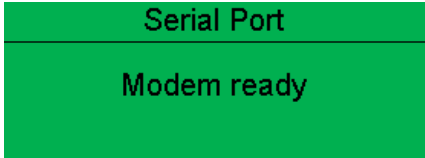

In case of communication failure between the modem and module, the modem is automatically reset, and initialisation is attempted once more:

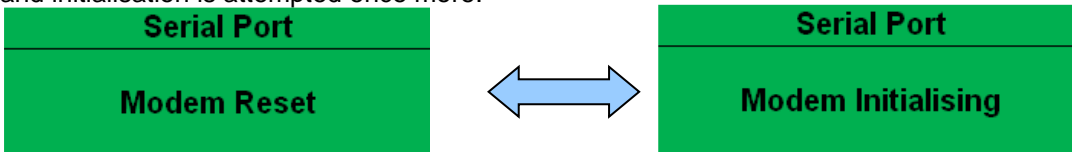

In the case of a module that is unable to communicate with the modem, the display continuously cycles between 'Modem Reset' and 'Modem Initialising' as the module resets the modem and attempts to communicate with it again, this continues until correct communication is established with the modem. In this instance, check connections and verify the modem operation.

**Modem Diagnostics**

Modem diagnostic screens are included; press the **Scroll Down**  button when viewing the *RS232 Serial Port* instruments to cycle to the available screens. If experiencing modem communication problems, this information aids troubleshooting.

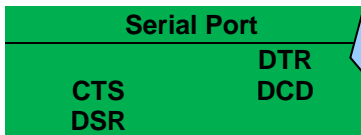

Shows the state of the modem communication lines. These can help diagnose connection problems.  
 Example:  
**RTS** A dark background shows the line is active.  
**RTS** A grey background shows that the line is toggling high and low  
**RTS** No background indicates that the line is inactive

Line	Description	
RTS	Request to Send	Flow Control
CTS	Clear to Send	Flow Control
DSR	Data Set Ready	Ready to Communicate
DTR	Data Terminal Ready	Ready to Communicate
DCD	Data Carrier Detect	Modem is Connected

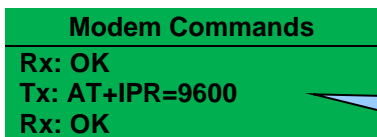

Shows the last command sent to the modem and the result of the command.



### **Connected to An RS232 MODBUS Master**

The modules operate as a MODBUS RTU slave device. In a MODBUS system, there is only one Master, typically a PLC, HMI system or PC SCADA system.

This master requests for information from the MODBUS slave (The module) and may (in control systems) also send request to change operating modes etc. Unless the Master makes a request, the slave is 'quiet' on the data link.

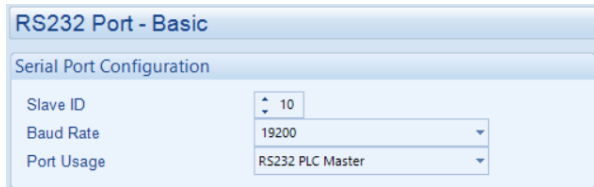

The factory settings are for the module to communicate at 19200 baud, MODBUS slave address 10.

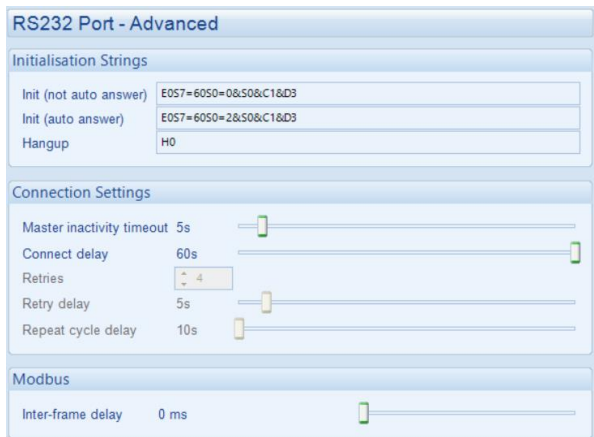

To use the RS232 port, ensure that 'port usage' is correctly set using the DSE Configuration Suite Software.

'Master inactivity timeout' should be set to at least twice the value of the system scan time. For example, if a MODBUS master PLC requests data from the module once per second, the timeout should be set to at least 2 seconds

The DSE MODBUS document containing register mappings inside the DSE module is available upon request from [support@deepseaelectronics.com](mailto:support@deepseaelectronics.com). Email the request along with the serial number of the DSE module to ensure the correct information is sent.

#### 4.4.8.2 RS485 SERIAL PORT

This section is included to give information about the currently selected serial port

The items displayed on this page change depending upon configuration of the module. Refer to the system supplier for further details.

**NOTE: Factory Default settings are for the RS485 port to operate at 19200 baud, MODBUS slave address 10.**

#### Connected to an R485 MODBUS Master

The modules operate as a MODBUS RTU slave device. In a MODBUS system, there is only one Master, typically a PLC, HMI system or PC SCADA system.

This master requests for information from the MODBUS slave (The module) and may (in control systems) also send request to change operating modes etc. Unless the Master makes a request, the slave is 'quiet' on the data link.

Serial Port	
Baud	19200
SlaveID	1
RS485	

The factory settings are for the module to communicate at 115200 baud, MODBUS slave address 10.

'Master inactivity timeout' should be set to at least twice the value of the system scan time. For example, if a MODBUS master PLC requests data from the module once per second, the timeout should be set to at least 2 seconds.

The screenshot shows the 'RS485 Port' configuration window with three sections:

- Basic:** Slave ID is set to 10, Baud Rate is 115200, and Port Usage is RS485 PLC Master.
- Advanced:** Master inactivity timeout is set to 5s.
- Modbus:** Inter-frame delay is 0 ms, Stop Bits is 1, and Parity checking is No Parity.

The DSE MODBUS document containing register mappings inside the DSE module is available upon request from support@deepseaelectronics.com. Email the request along with the serial number of the DSE module to ensure the correct information is sent.

#### Typical Requests (Using Pseudo Code)

**BatteryVoltage=ReadRegister(10,0405,1):** reads register (hex) 0405 as a single register (battery volts) from slave address 10.

**WriteRegister(10,1008,2,35701, 65535-35701):** Puts the module into AUTO mode by writing to (hex) register 1008, the values 35701 (auto mode) and register 1009 the value 65535-35701 (the bitwise opposite of auto mode)

**Warning=(ReadRegister(10,0306,1) >> 11) & 1):** reads (hex) 0306 and looks at bit 12 (Warning alarm present)

**ElectricalTrip=(ReadRegister(10,0306,1) >> 10) & 1):** reads (hex) 0306 and looks at bit 11 (Electrical Trip alarm present)

**ControlMode=ReadRegister(10,0304,2):** reads (hex) register 0304 (control mode).

#### 4.4.9 USER DEFINED STRINGS

**NOTE:** For further details of module configuration, refer to DSE Publication: *057-243 DSE7310 MKII & DSE7320 MKII Configuration Software Manual*.

The user define strings are intended to contain generic important information about the generator such as oil service internal information. The contents of these screens vary depending upon configuration by the engine manufacturer or supplier.

Under default factory settings the support strings are not viewable. They are configurable by the system designer using the DSE Configuration Suite software.

The display below example screen is achieved using the settings shown in the below screen shot of the DSE Configuration Suite Software:

The screenshot displays a software interface with a green sidebar on the left and a main configuration area on the right. The sidebar contains the text 'Oil Service', 'Every 500 Hours', and 'Every 5 Months'. The main area is titled 'User Defined Strings' and shows 'Page 1' with a table of settings:

Field	Value
Page Title	Engine
Line 1	Oil Service
Line 2	Every 500 Hours
Line 3	Every 5 Months

#### 4.4.10 SCHEDULE

**NOTE:** For further details on the operation of the inbuilt scheduler feature, refer to section 5.6 entitled *Scheduler* in the *Operation* section of this document.

**NOTE:** For further details of module configuration, refer to DSE Publication: *057-243 DSE7310 MKII & DSE7320 MKII Configuration Software Manual*.

The controller contains an inbuilt exercise run scheduler, capable of automatically starting and stopping the set or inhibiting the set from starting. Up to 16 scheduled (in two banks of 8) start/stop/inhibiting start sequences can be configured to repeat on a 7-day or 28-day cycle.

Scheduled runs may be on load or off load depending upon module configuration.

This section of the module's display shows how exactly the scheduler (if enabled) is configured. Under default factory settings the Schedule is not viewable. It is enabled by the system designer using the DSE Configuration Suite software.

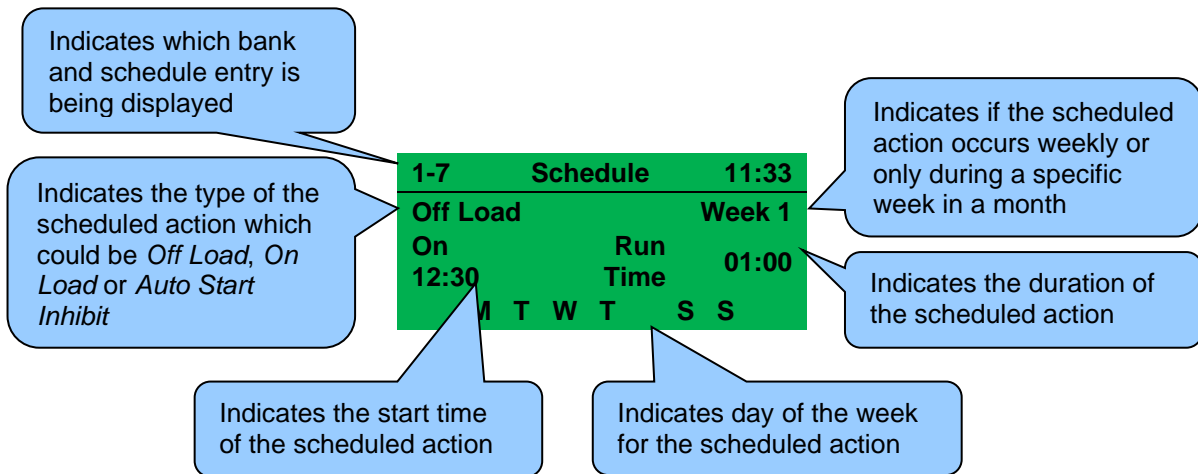

#### 4.4.11 PLC INSTRUMENTS

**NOTE:** For further details of module configuration, refer to DSE Publication: *057-243 DSE7310 MKII & DSE7320 MKII Configuration Software Manual.*

Contains values from various elements from the module's internal PLC editor to enable the user to view them from the module's fascia.



Press the **Instrumentation Scroll** buttons scroll through the **PLC Instruments** parameters if configured.

##### Counter Example:

PLC Instruments	
Counter 1	
Actual	5
Set Point	15

**Counter 1:** The name of the counter as configured in the PLC.  
**Actual:** The number the counter has currently reached.  
**Set Point:** The number at which the counter stops incrementing

##### Register Example:

PLC Instruments	
Register 1	
	58

**Register 1:** The name of the register as configured in the PLC.  
**Value:** The value the register currently contains.

##### Store Example:

PLC Instruments	
Store 1	
	127

**Store:** The name of the store as configured in the PLC.  
**Value:** The value the store currently contains. This value can be edited from the fascia by pressing and holding the **Tick** button and then using the **Instrumentation Scroll** buttons to change the value.

##### Timer Example:

PLC Instruments	
Timer 1	
Actual	00:34:17
Set Point	01:50:30

**Timer 1:** The name of the timer as configured in the PLC.  
**Actual:** The time the timer has currently reached.  
**Set Point:** The time at which the timer stops incrementing

#### 4.4.12 CONFIGURABLE CAN

**NOTE:** For further details of module configuration, refer to DSE Publication: *057-243 DSE7310 MKII & DSE7320 MKII Configuration Software Manual.*

The configurable CAN instruments are intended to display CAN information from external third party CAN devices such as fuel flow meters. The contents of these screens vary depending upon configuration by the engine manufacturer or supplier.

Under default factory settings the configurable CAN instruments are not viewable. They are configurable by the system designer using the DSE Configuration Suite software.

**Example:**

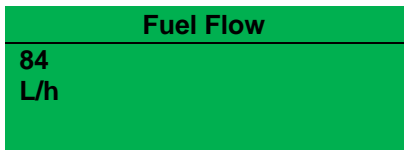

Configurable CAN Instrument 1 to 30

#### 4.4.13 AVR CAN

 **NOTE: For further details of module configuration, refer to DSE Publication: 057-262 DSE7410 MKII & DSE7420 MKII Configuration Software Manual.**

These pages contain instrumentation gathered from the AVR when connected by CAN and covers generator instrumentation and AVR configuration.

Under default factory settings the AVR CAN instruments are not viewable. They are configurable by the system designer using the DSE Configuration Suite software.



Press the **Instrumentation Scroll** buttons scroll through the **PLC Instruments** parameters if configured.

**Generator Voltage**

---

**230**

- Voltage Set Point Preset Enable
- Voltage Set Point
- Drop Preset Enable
- Drop (% of Set Point)
- Offset Angle
- Full Load Current
- External Bias Pot Enable
- External Pot Range (%)
- External Bias Voltage Enable
- External Voltage Range (%/V)
- External Voltage Offset
- UFRO Preset Enable
- UFRO Knee Point
- Instantaneous Mode Enable
- Instantaneous Step
- Ramp Rate (%/Hz)
- Dwell Time
- Ramp Up Rate After Dwell (%/s)
- Trip Point
- Proportional Preset Enable
- Proportional Preset Range
- Proportional Set Point
- Integral Preset Enable
- Integral Preset Range
- Integral Set Point
- Derivative Set Point
- Off Load Duty Cycle
- Maximum Duty Cycle
- Output Limit Overshoot %
- Output Limit Overshoot Delay
- Soft Start Ramp Start Point (%)
- Soft Start Ramp Rate (%/Hz)
- Start-up Fail Delay
- Loss of Feedback Delay
- Over Excite Trip

Continued over page...

Over Excite Delay  
 External Pot OC Alarm Enable  
 Generator Frequency  
 Generator Voltage  
 Droop Current  
 Excitation Voltage  
 Auxiliary Voltage  
 External Potentiometer  
 External Voltage  
 Alternative Configuration  
 Stability Selection  
 Software Version

**4.4.13.1 AVR CURRENT DTCS**

 **NOTE: For details on these code/graphic meanings, refer to the AVR instructions provided by the manufacturer, or contact the manufacturer for further assistance.**

When connected to a suitable CAN AVR, the controller displays alarm status messages from the AVR in the *Alarms* section of the display.

<b>1/1</b>	<b>Alarms</b>
<b>AVR Fault</b>	
<b>Warning</b>	

Type of alarm that is triggered on the DSE module, e.g. Warning

Press the **Next Page**  button until the *AVR Current DTCs* (Diagnostic Trouble Codes) page is displayed to access the list of DTCs from the AVR which are DM1 messages.

<b>1/2</b>	<b>AVR Current DTCs</b>
<b>Start-up Failed Trip Fault Exists</b>	
<b>SPN=520193 , FMI=31, OC=1</b>	

The DM1 DTC is interpreted by the module and is shown on the module's display as a text message. In addition to this, the manufacturer's DTC is shown below.



#### 4.4.14 ABOUT

##### 4.4.14.1 MODULE INFORMATION

Contains important information about the module and the firmware versions. This information may be asked for when contacting DSE Technical Support Department for advice.

About	
Variant	7320H
Application	V1.1.11
USB ID	BC614E

**Variant:** 73xx MKII  
**Application Version:** The version of the module's main firmware file (Updatable using the Firmware Update Wizard in the DSE Configuration Suite Software).  
**USB ID:** Unique identifier for PC USB connection



Press the **Scroll Down** button to access more information about the module.

About	
Bootloader	V3.0.18
Analogue	V1.0.14

**Bootloader:** Firmware Update bootloader software version  
**Analogue:** Analogue measurements software version

About	
Engine Type	Volvo EMS2b
Version	V1.21

**Engine Type:** The name of the engine file selected in the configuration  
**Version:** Engine type file version.

##### 4.4.14.2 DUAL MUTUAL



Whilst in the *About* section, press **Scroll Down** button to access more information about the Dual Mutual Standby.

About	
Dual Mutual	V2.0.0
No of Sets	2
Run Time	4h 38m

**Dual Mutual:** Dual Mutual Software version  
**No of Sets:** Number of sets detected on the comms link.  
**Run Time:** Number of accumulated engine hours or dual mutual hours.

#### 4.5 USER CONFIGURABLE INDICATORS

These LEDs are configured by the user to indicate any one of **100+ different functions** based around the following: -

**Indications** - Monitoring of a digital input and indicating associated functioning user's equipment - *Such as Battery Charger On or Louvres Open, etc.*

**Warnings, Electrical Trips & Shutdowns Alarms** - Specific indication of a particular warning or shutdown condition, backed up by LCD indication - *Such as Low Oil Pressure Shutdown, Low Coolant level, etc.*

**Status Indications** - Indication of specific functions or sequences derived from the modules operating state - *Such as Safety On, Pre-heating, Panel Locked, etc.*



## 5 OPERATION

**NOTE:** The following descriptions detail the sequences followed by a module containing the standard 'factory configuration'. Always refer to your configuration source for the exact sequences and timers observed by any particular module in the field.

### 5.1 QUICKSTART GUIDE

This section provides a quick start guide to the module's operation.

#### 5.1.1 STARTING THE ENGINE

**NOTE:** For further details, see the section 5 entitled *Operation* in this document.



### 5.1.2 STOPPING THE ENGINE

**NOTE:** For further details, see the section 5 entitled *Operation* in this document.





## 5.2 STOP/RESET MODE

 **NOTE:** If a digital input configured to *Panel Lock* is active, changing module modes is not possible. Viewing the instruments and event logs is NOT affected by *Panel Lock*.

 **NOTE:** For further details of module configuration, refer to DSE Publication: *057-243 DSE7310 MKII & DSE7320 MKII Configuration Software Manual*.

**Stop/Reset Mode** is activated by pressing the **Stop/Reset Mode**  button.

The LED above the **Stop/Reset Mode**  button illuminates to indicate **Stop/Reset Mode**  operation.

In **Stop/Reset Mode** , the module removes the generator from load (if necessary) before stopping the generator.

If the generator does not stop when requested, the *Fail To Stop* alarm is activated (subject to the setting of the *Fail to Stop* timer). To detect the engine at rest the following must occur:

- Engine speed is zero as detected by the CAN ECU
- Generator AC Voltage and Frequency must be zero.
- Engine Charge Alternator Voltage must be zero.
- Oil pressure sensor must indicate low oil pressure

When the engine has stopped and the module is in the **Stop/Reset Mode** , it is possible to send configuration files to the module from DSE Configuration Suite PC software and to enter the Front Panel Editor to change parameters.

Any latched alarms that have been cleared are reset when **Stop/Reset Mode**  is entered.

The engine is not started when in **Stop/Reset Mode** . If start signals are given, the input is ignored until **Auto Mode**  is entered.

If *Immediate Mains Dropout* is enabled and the module is in **Stop/Reset Mode** , the mains load switch is opened and closed as appropriate when the mains fails or becomes available to take load.



When left in **Stop/Reset Mode**  with no presses of the fascia buttons, no form of communication active and configured for *Power Save Mode*, the module enters *Power Save Mode*. To 'wake' the module, press any fascia control buttons.

Power Save Mode in the DSE Configuration Suite Software

Power Save Mode Enable





### 5.2.1 ECU OVERRIDE

Pressing the **Start**  button in **Stop/Reset Mode**  powers up the engine's ECU but does not start the engine. This can be used to check the status of the CAN communication and to prime the fuel system.

## 5.3 MANUAL MODE

 **NOTE: If a digital input configured to Panel Lock is active, changing module modes is not possible. Viewing the instruments and event logs is NOT affected by panel lock.**

**Manual Mode** is activated by pressing the **Manual Mode**  button.

The LED above the **Manual Mode**  button illuminates to indicate **Manual Mode**  operations.

In **Manual Mode**  the generator does not start automatically

To begin the starting sequence, press the **Start**  button.

### 5.3.1 STARTING SEQUENCE

 **NOTE: There is no *Start Delay* in this mode of operation.**

 **NOTE: If the unit has been configured for CAN, compatible ECU's receives the start command via CAN.**

 **NOTE: For further details of module configuration, refer to DSE Publication: 057-243 DSE7310 MKII & DSE7320 MKII Configuration Software Manual.**

The fuel relay is energised, and the engine is cranked.

If the engine fails to fire during this cranking attempt, then the starter motor is disengaged for the *Crank Rest Timer* duration after which the next start attempt is made. Should this sequence continue beyond the set *Number Of Attempts*, the start sequence is terminated, and the display shows *Fail to Start*.

The starter motor is disengaged when the engine fires. Speed detection is factory configured to be derived from the AC alternator output frequency but can additionally be measured from a Magnetic Pickup mounted on the flywheel or from the CANbus link to the engine ECU depending on module configuration.

Additionally, rising oil pressure can be used to disconnect the starter motor (but cannot detect underspeed or overspeed).

After the starter motor has disengaged, the *Safety On Delay* timer activates, allowing Oil Pressure, High Engine Temperature, Under-speed, Charge Fail and any delayed Auxiliary fault inputs to stabilise without triggering the fault.

### 5.3.2 ENGINE RUNNING

 **NOTE:** The load transfer signal remains inactive until the generator is available. This prevents excessive wear on the engine and alternator.

 **NOTE:** For further information on enabling Manual Breaker Control, refer to DSE Publication: 057-243 DSE7310 MKII & DSE7320 MKII Configuration Software Manual.

When in **Manual Mode**  the load is transferred to the generator whenever a 'loading request' is made. The possible sources for 'loading requests' are limited dependant on the state of the *Manual Breaker Control* function.



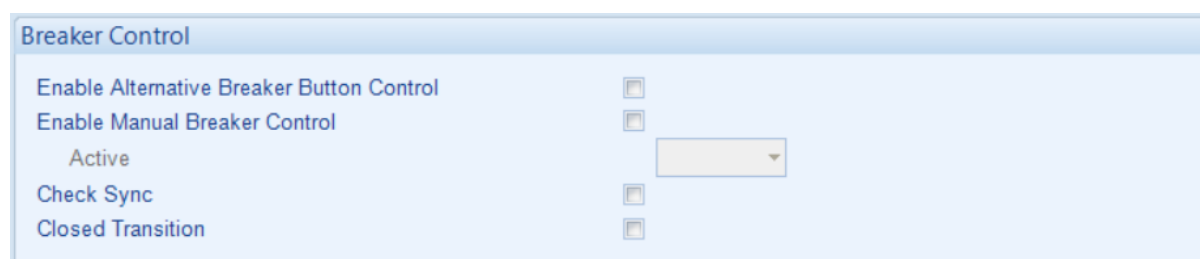

#### 5.3.2.1 MANUAL BREAKER CONTROL DISABLED



A loading request may come from any of the following sources:

- Press the Transfer to Generator  button.
- Failure of mains supply (DSE7320 MKII only)
- Activation of an auxiliary input that has been configured to *Remote Start On Load, Transfer To Generator / Open Mains* or *Auxiliary Mains Fail* (DSE7320 MKII Only).
- Activation of the inbuilt exercise scheduler if configured for 'on load' runs.
- Activation of *Dual Mutual Standby Balance Mode*, see section 6 entitled *Operation (Dual Mutual Standby)* in this document for more information.
- Instruction from external remote telemetry devices using the RS232, RS485 or Ethernet interface.

Once the generator is placed on load, it will not automatically be removed. Depending on loading request state, one of the following methods is used to manually open the load switch:

- If the loading request has been removed:
  - Press the **Open Generator**  (DSE7310 MKII Only) or **Transfer to Mains**  (DSE7320 MKII Only) button
  - Activation of an auxiliary input that has been configured to *Transfer To Mains / Open Generator*.
  - Press the **Auto Mode**  button to return to automatic mode. The set observes all **Auto Mode**  start requests and stopping timers before beginning the *Auto Mode Stopping Sequence*.
- If the loading request remains active:
  - Press the **Stop/Reset Mode**  button to remove load and stop the generator.
  - Activation of an auxiliary input that has been configured to *Generator Load Inhibit*.





### 5.3.2.2 MANUAL BREAKER CONTROL ENABLED

Breaker Control	
Enable Alternative Breaker Button Control	<input type="checkbox"/>
Enable Manual Breaker Control	<input checked="" type="checkbox"/>
Active	Always
Check Sync	<input type="checkbox"/>
Closed Transition	<input type="checkbox"/>

Loading request sources are limited to:



- Press the Transfer to Generator  button.
- Activation of an auxiliary input that has been configured to *Transfer To Generator / Open Mains*.

Once the generator is placed on load, it will not automatically be removed. Any one of the following methods are used to manually open the load switch:

- Press the **Open Generator**  (DSE7310 MKII Only) or **Transfer to Mains**  (DSE7320 MKII Only) button
- Activation of an auxiliary input that has been configured to *Transfer To Mains / Open Generator*.
- Press the **Auto Mode**  button to return to automatic mode. The set observes all **Auto Mode**  start requests and stopping timers before beginning the *Auto Mode Stopping Sequence*.
- Press the **Stop/Reset Mode**  button to remove load and stop the generator.
- Activation of an auxiliary input that has been configured to *Generator Load Inhibit*.

### 5.3.3 STOPPING SEQUENCE

In **Manual Mode**  the set continues to run until either:



- The **Stop/Reset Mode**  button is pressed – The delayed load outputs are de-activated immediately and the set immediately stops.
- The **Auto Mode**  button is pressed. The set observes all **Auto Mode**  start requests and stopping timers before beginning the *Auto Mode Stopping Sequence*.





## 5.4 TEST MODE

 **NOTE:** If a digital input configured to *Panel Lock* is active, changing module modes is not possible. Viewing the instruments and event logs is NOT affected by *Panel Lock*.

*Test Mode* is activated by pressing the *Test Mode*  button.

The LED above the *Test Mode*  button illuminates to indicate *Test Mode*  operations.

In *Test Mode* , the set does not start automatically.

To begin the starting sequence, press the *Start*  button.

### 5.4.1 STARTING SEQUENCE

 **NOTE:** There is no *Start Delay* in this mode of operation.

 **NOTE:** If the unit has been configured for CAN, compatible ECU's receives the start command via CAN.

 **NOTE:** For further details of module configuration, refer to DSE Publication: *057-243 DSE7310 MKII & DSE7320 MKII Configuration Software Manual*.

The fuel relay is energised, and the engine is cranked.

If the engine fails to fire during this cranking attempt, then the starter motor is disengaged for the *crank rest* duration after which the next start attempt is made. Should this sequence continue beyond the set number of attempts, the start sequence is terminated, and the display shows *Fail to Start*.

The starter motor is disengaged when the engine fires. Speed detection is factory configured to be derived from the AC alternator output frequency but can additionally be measured from a Magnetic Pickup mounted on the flywheel or from the CANbus link to the engine ECU depending on module configuration.

Additionally, rising oil pressure can be used to disconnect the starter motor (but cannot detect underspeed or overspeed).



After the starter motor has disengaged, the *Safety On Delay* timer activates, allowing Oil Pressure, High Engine Temperature, Under-speed, Charge Fail and any delayed Auxiliary fault inputs to stabilise without triggering the fault.



## 5.4.2 ENGINE RUNNING

**NOTE:** The load transfer signal remains inactive until the generator is available. This prevents excessive wear on the engine and alternator.

In **Test Mode** , the load is automatically transferred to the generator.



Once the generator has been placed on load, it is not automatically removed. To manually remove the load either:

Press the **Manual Mode**  button followed by the **Open Generator**  (DSE7310 MKII Only) or **Transfer to Mains**  (DSE7320 MKII Only) button.

- Press the **Auto Mode**  button to return to automatic mode. The set observes all **Auto Mode**  start requests and stopping timers before beginning the *Auto Mode Stopping Sequence*.
- Press the **Stop/Reset Mode**  button to remove load and stop the generator.
- Activation of an auxiliary input that has been configured to *Generator Load Inhibit*.

## 5.4.3 STOPPING SEQUENCE

In **Test Mode**  the set continues to run until either:

- The **Stop/Reset Mode**  button is pressed – The delayed load outputs are de-activated immediately and the set immediately stops.
- The **Auto Mode**  button is pressed. The set observes all **Auto Mode**  start requests and stopping timers before beginning the *Auto Mode Stopping Sequence*.

## 5.5 AUTOMATIC MODE

 **NOTE:** If a digital input configured to external *Panel Lock* is active, changing module modes is not possible. Viewing the instruments and event logs is NOT affected by *Panel Lock*.

**Auto Mode** is activated by pressing the **Auto Mode**  button.

The LED above the **Auto Mode**  button illuminates to indicate **Auto Mode**  operations.

**Auto Mode**  allows the generator to operate fully automatically, starting and stopping as required with no user intervention.

### 5.5.1 WAITING IN AUTO MODE

If a starting request is made, the starting sequence begins. Starting requests can be from the following sources:

- Failure of mains supply (DSE7320 MKII only)
- Activation of an auxiliary input that has been configured to *Remote Start*
- Activation of an auxiliary input that has been configured to *Auxiliary Mains Fail* (DSE7320 MKII Only).
- Activation of the inbuilt exercise scheduler.
- Instruction from external remote telemetry devices using the RS232 or RS485 interface.
- Activation of *Dual Mutual Standby Balance Mode*, see section 6 entitled *Operation (Dual Mutual Standby)* in this document for more information.

## 5.5.2 STARTING SEQUENCE

 **NOTE:** If the unit has been configured for CAN, compatible ECU's receive the start command via CAN and transmit the engine speed to the DSE controller.

 **NOTE:** For further details of module configuration, refer to DSE Publication: *057-243 DSE7310 MKII & DSE7320 MKII Configuration Software Manual*.

To allow for 'false' start requests, the *Start Delay* timer begins.

Should all start requests be removed during the *Start Delay* timer, the unit returns to a stand-by state.

If a start request is still present at the end of the *Start Delay* timer, the fuel relay is energised, and the engine is cranked.

If the engine fails to fire during this cranking attempt, then the starter motor is disengaged for the *Crank Rest* duration after which the next start attempt is made. Should this sequence continue beyond the *Set Number Of Attempts*, the start sequence is terminated, and the display shows *Fail to Start*.

The starter motor is disengaged when the engine fires. Speed detection is factory configured to be derived from the AC alternator output frequency but can additionally be measured from a Magnetic Pickup mounted on the flywheel or from the CAN link to the engine ECU depending on module.

Additionally, rising oil pressure can be used to disconnect the starter motor (but cannot detect underspeed or overspeed).

After the starter motor has disengaged, the *Safety On Delay* timer activates, allowing Oil Pressure, High Engine Temperature, Under-speed, Charge Fail and any delayed Auxiliary fault inputs to stabilise without triggering the fault.

### 5.5.3 ENGINE RUNNING

 **NOTE: The load transfer signal remains inactive until the generator is available. This prevents excessive wear on the engine and alternator.**

The generator is placed on load if configured to do so.

If all start requests are removed, the *Stopping Sequence* begins.

### 5.5.4 STOPPING SEQUENCE

The *Return Delay* timer operates to ensure that the starting request has been permanently removed and is not just a short-term removal. Should another start request be made during the cooling down period, the set returns on load.

If there are no starting requests at the end of the *Return Delay* timer, the load is transferred from the generator to the mains supply and the *Cooling Down* timer is initiated.

The *Cooling Down* timer allows the set to run off load and cool sufficiently before being stopped. This is particularly important where turbo chargers are fitted to the engine.

After the *Cooling Down* timer has expired, the set is stopped.

## 5.6 SCHEDULER

The controller contains an inbuilt exercise run scheduler, capable of automatically starting and stopping the set or inhibiting the set from starting. Up to 16 scheduled (in two banks of 8) start/stop/inhibiting start sequences can be configured to repeat on a 7-day or 28-day cycle.

Scheduled runs may be on load or off load depending upon module configuration.

### Example:

Screen capture from DSE Configuration Suite Software showing the configuration of the Exercise Scheduler.



In this example the set starts at 09:00 on Monday and run for 5 hours off load, then start at 13:30 on Tuesday and run for 30 minutes one load and is inhibited from automatically starting on Monday from 17:00 for 12 hours.

Bank 1					
Schedule Period Monthly					
Week	Day	Run Mode	Start Time	Duration	
First	Monday	Off Load	09:00	05:00	Clear
First	Tuesday	On Load	13:30	00:30	Clear
First	Monday	Auto Start Inhibi	17:00	12:00	Clear
First	Monday	Off Load	00:00	00:00	Clear
First	Monday	Off Load	00:00	00:00	Clear
First	Monday	Off Load	00:00	00:00	Clear
First	Monday	Off Load	00:00	00:00	Clear
First	Monday	Off Load	00:00	00:00	Clear

### 5.6.1 STOP MODE

- Scheduled runs do not occur when the module is in **Stop/Reset Mode** .





### 5.6.2 MANUAL MODE

- Scheduled runs do not occur when the module is in **Manual Mode**  waiting for a start request.
- Activation of a Scheduled Run 'On Load' when the module is operating Off Load in **Manual Mode**  forces the set to run On Load.

### 5.6.3 TEST MODE

- Scheduled runs do not occur when the module is in **Test Mode**  waiting for a start request.

### 5.6.4 AUTO MODE

- Scheduled runs operate only if the module is in **Auto Mode**  with no *Shutdown* or *Electrical Trip* alarm active.
- If the module is in **Stop/Reset Mode**  or **Manual Mode**  when a scheduled run begins, the engine is not started. However, if the module is moved into **Auto Mode**  during a scheduled run, the engine is called to start.
- Depending upon configuration by the system designer, an external input can be used to inhibit a scheduled run.
- If the engine is running *Off Load* in **Auto Mode**  and a scheduled run configured to 'On Load' begins, the set is placed *On Load* for the duration of the Schedule.

## 5.7 ALTERNATIVE CONFIGURATIONS

Depending upon the configuration of the system by the generator supplier, the system may have selectable configurations (for example to select between 50 Hz and 60 Hz). If this has been enabled the generator supplier will advise how this selection can be made (usually by operating an external selector switch or by selecting the required configuration file in the module's front panel configuration editor).

## 5.8 DUMMY LOAD / LOAD SHEDDING CONTROL

If the load is low, 'dummy loads' (typically resistive load banks) are introduced to ensure the engine is not too lightly loaded. Conversely, as the load increases towards the maximum rating of the set, non-essential loads are shed to prevent overload of the generator.

### 5.8.1 DUMMY LOAD CONTROL

The *Dummy Load Control* feature (if enabled) allows for a maximum of five dummy load steps. When the set is first started, all configured *Dummy Load Control* outputs are de-energised. Once the generator is placed onto load, the generator loading is monitored by the *Dummy Load Control* scheme.

If the generator loading falls below the *Dummy Load Control Trip* setting (kW), the *Dummy Load Control Trip Delay* begins. If the generator loading remains at this low level for the duration of the timer, the first *Dummy Load Control* output is energised. This is used to energise external circuits to switch in a resistive load bank.

The first dummy load has increased the generator loading. Again, the generator loading is monitored. This continues until all configured *Dummy Load Control* outputs are energised.

When the generator loading rises above the *Dummy Load Return* level, the *Dummy Load Return Delay* begins. If the generator loading remains at these levels after the completion of the timer, the 'highest' active *Dummy Load Control* output is de-energised. This continues until all *Dummy Load Control* outputs have been de-energised.

When the generator enters a stopping sequence for any reason, all the *Dummy Load Control* outputs de-energise at the same time as the generator load switch is signalled to open.

Example screen shot of *Dummy Load Control* setup in the DSE Configuration Suite

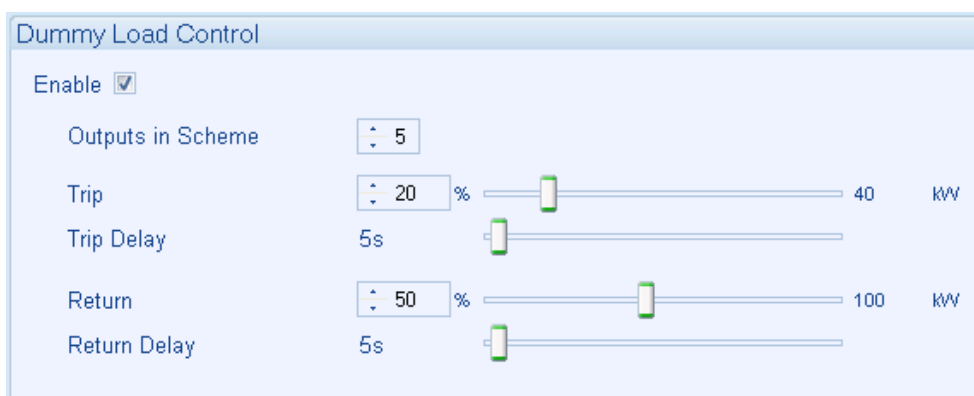

## 5.8.2 LOAD SHEDDING CONTROL

The *Load Shedding Control* feature (if enabled) allows for a maximum of five load shedding steps. When the generator is about to take load, the configured number of *Load Shedding Control Outputs at Start* will energise. This allows certain non-essential loads to be removed prior to the generator's load switch being closed. This is used to ensure the initial loading of the generator is kept to a minimum, below the *Load Acceptance* specification of the generator.

The generator is then placed on load. The *Load Shedding Control* scheme begins. When the generator loading exceeds the *Load Shedding Trip* level the *Trip Delay* timer will start. If the generator loading is still high when the timer expires, the first *Load shedding Control* output energises. When the generator loading has been above the trip level for the duration of the timer the 'next' *Load Shedding Control* output energises and so on until all *Load Shedding Control* outputs are energised.

When the generator loading falls below the *Load Shedding Return* level, the *Return Delay Time* starts. If the generator load remains below the *Load Shedding Return* level when the timer has expired, the 'highest' *Load Shedding Control* output de-energises. This process continues until all outputs have been de-energised.

When the generator enters a stopping sequence for any reason, all the *Load Shedding Control* outputs de-energise at the same time as the generator load switch is signalled to open.

Example screen shot of *Load Shedding Control* setup in the DSE Configuration Suite:

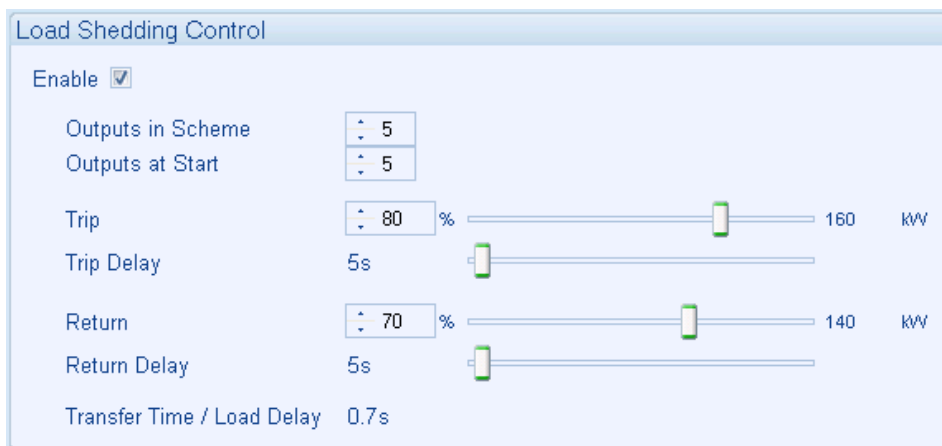



## 5.9 CHANGEOVER FUNCTIONALITY (DSE7320 MKII ONLY)

The changeover functionality between mains and generator is dependent on how the DSE module is configured. A brief description of the operation of each scheme is detailed in the following sections.

### 5.9.1 OPEN TRANSITION WITHOUT CHECK SYNC

**NOTE:** When using *Open Transition*, it is recommended that digital inputs are configured for *Generator Closed Auxiliary* and *Mains Closed Auxiliary* to provide additional interlock protection.

By default, the DSE module performs an open transition without check sync, with a pre-configured transfer delay between opening one load switch and closing the other. When changing over from mains to generator, the module requests that the mains load switch opens. Once the *Mains Closed Auxiliary* indicates the mains load switch has opened, the *Transfer Time* begins. After the *Transfer Time* expires, the module attempts to close the generator load switch. The operating philosophy is the same when going from generator to mains and the complete transition is shown below in the timing diagram.

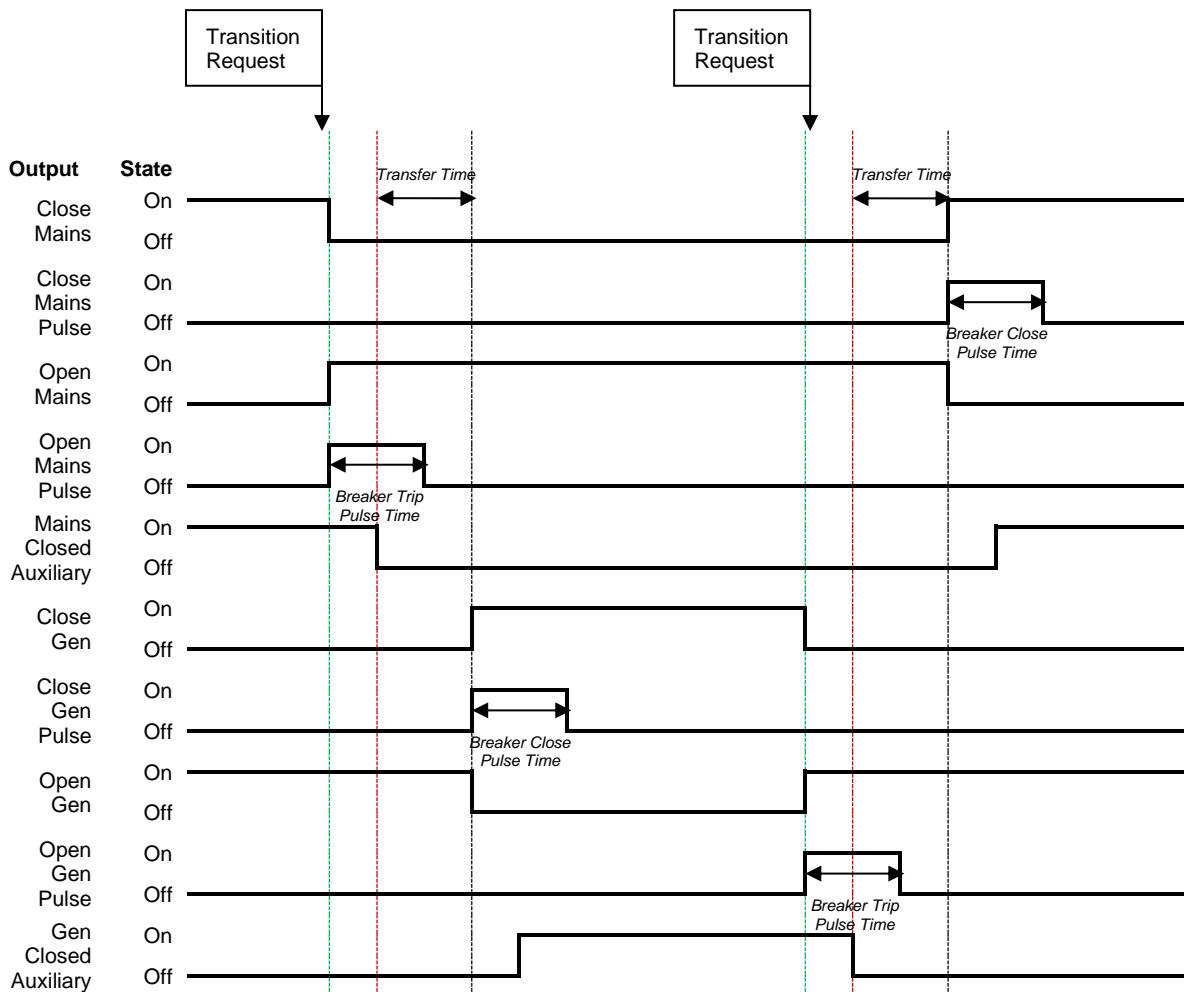

### 5.9.2 OPEN TRANSITION WITH CHECK SYNC

**NOTE:** When using *Open Transition*, it is recommended that digital inputs are configured for *Generator Closed Auxiliary* and *Mains Closed Auxiliary* to provide additional interlock protection.

**NOTE:** *Check Sync* is not available when using the *Dual Mutual Standby* feature.

**NOTE:** When using *Open Transition With Check Sync* without enabling the *Check Sync Assist* to actively control the synchronising, it is advised that the *Return to Open Transition* is enabled. If *Return to Open Transition* is enabled, the module performs an open transition without check sync if the supplies fail to synchronise within the configured time. For further details of module configuration, refer to DSE Publication: 057-243 *DSE7310 MKII & DSE7320 MKII Configuration Software Manual*.

It is possible to configure the DSE module to perform an open transition with check sync, with a pre-configured transfer delay between opening one load switch and closing the other. When changing over from mains to generator, the module waits for the two supplies to become in sync (by passive or actively synchronising depending on configuration). After the supplies become in sync, the module requests that the mains load switch opens. Once the *Mains Closed Auxiliary* indicates the mains load switch has opened, the *Transfer Time* begins. After the *Transfer Time* expires, the module attempts to close the generator load switch. The operating philosophy is the same when going from generator to mains and the complete transition is shown below in the timing diagram.

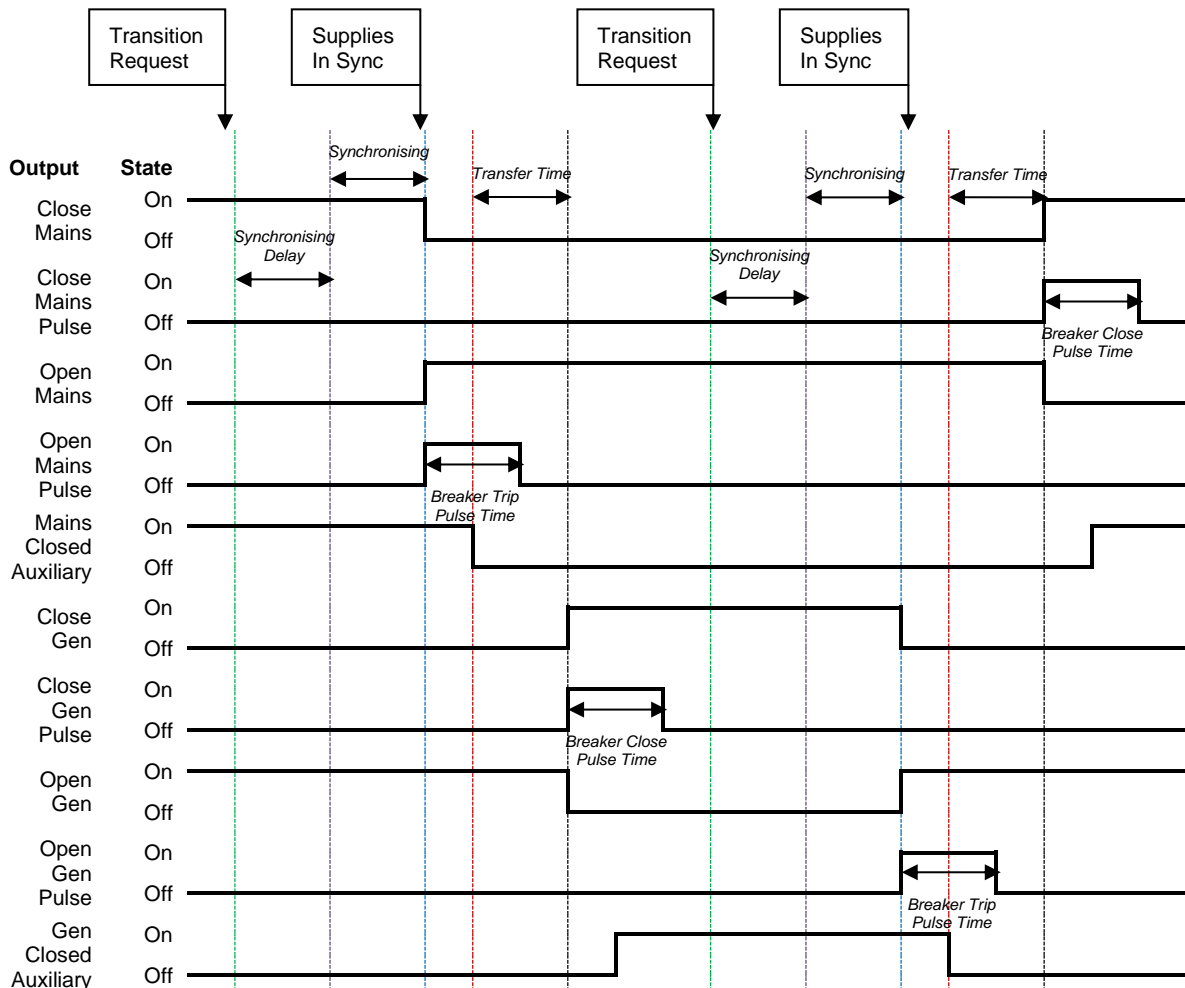

### 5.9.3 CLOSED TRANSITION WITH CHECK SYNC

 **NOTE:** *Closed Transition With Check Sync* is not available when using the *Dual Mutual Standby* feature.

 **NOTE:** When using *Closed Transition With Check Sync*, digital inputs must be configured for *Generator Closed Auxiliary* and *Mains Closed Auxiliary*.

 **NOTE:** When using *Closed Transition With Check Sync*, mechanical interlock must not be fitted. It is recommended that external electrical interlock provided but overridden using and output configured as *Interlock Override*.

 **NOTE:** When using *Closed Transition With Check Sync* without enabling the *Check Sync Assist* to actively control the synchronising, it is advised that the *Return to Open Transition* is enabled. If *Return to Open Transition* is enabled, the module performs an open transition without check sync if the supplies fail to synchronise within the configured time. For further details of module configuration, refer to DSE Publication: 057-243 *DSE7310 MKII & DSE7320 MKII Configuration Software Manual*.

It is possible to configure the DSE module to perform a closed transition with check sync, with a pre-configured parallel time when both load switches are closed. When changing over from mains to generator, the module waits for the two supplies to become in sync (by passive or actively synchronising depending on configuration). After the supplies become in sync, the module requests that the generator load switch closes. Once the *Generator Closed Auxiliary* indicates the generator load switch has closed, the *Paralleling Time* begins. After the *Paralleling Time* expires, the module attempts to open the mains load switch. The operating philosophy is the same when going from generator to mains and the complete transition is shown in the timing diagram overleaf.



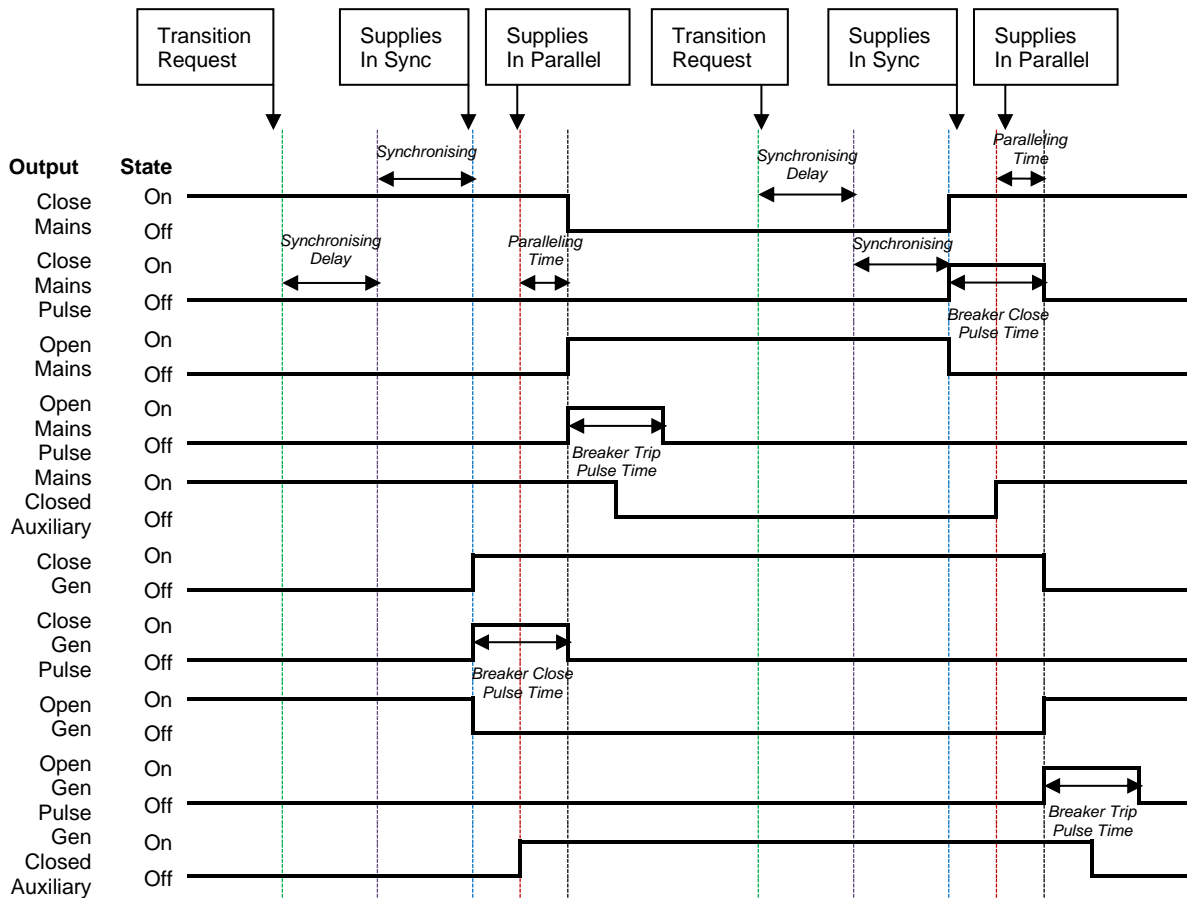

# Operation



## 5.10 SMS CONTROL

The *SMS Control* feature (if enabled) allows the user to send control commands to the module via SMS message. There are five control commands that the user can send to the module shown in the table below.

**NOTE: Multiple SMS Control Commands CANNOT be sent in a single SMS message.**



Control Command Number	Module Action
1	Start the generator and run off load if the controller is in the <b>Auto Mode</b>  .
2	Start the generator and run-on load if the controller is in the <b>Auto Mode</b>  .
3	Cancel the SMS start request leaving the module in its current operating mode.
4	Put the module into the <b>Stop/Reset Mode</b>  .
5	Put the module into the <b>Auto Mode</b>  .

To send an SMS command, the user requires (if configured) the *SMS Control Pin* and the *Control Command Number*. Only these numbers must be included in the SMS, the module does not respond to any SMS with extra characters or missing PIN (if configured). Below is an example showing how to start and run the generator on load by SMS message.

**NOTE: There MUST be a space between the SMS PIN and the Control Command Number**

PIN

Control Command Number

SMS Message 1 0123 5	This SMS message places the module into the <b>Auto Mode</b>  .
SMS Message 2 0123 2	This SMS message will start generator and run it on load.
SMS Message 3 0123 3	This SMS message will remove the start and run command given by the previous SMS message and leave the module in the <b>Auto Mode</b>  .
SMS Message 4 0123 4	This SMS message will place the module into the <b>Stop/Reset Mode</b>  .

Example screenshot of *SMS Control* setup in the DSE Configuration Suite:



## 6 OPERATION (DUAL MUTUAL STANDBY)

The following description details the sequences followed by a module containing the default factory settings modified to allow two controllers to operate in *Dual Mutual Standby*. The operating modes are as per the standard operation documented in section 5 entitled *Operation* in this manual with the addition of the *Dual Mutual Standby* functions detailed below.

If the completed generator set or control panel has been purchased from a third-party supplier, the module's configuration would have been changed by them to suit their requirements. Always refer to the module's configuration source for the exact sequences and timers observed by any module in the field.

### 6.1 USING TWO DSE7310 MKII

 **NOTE: In all operating modes, only one DSE7310 MKII is permitted to close its Generator load switching device at any time.**

 **NOTE: Mechanical and/or electrical interlocks between the load switches is required.**

When using the two DSE7310 MKII modules, one on each generator, the *Dual Mutual Standby* feature allows a priority generator to be backed up. The generators starting and stopping to achieve this occurs automatically with no user intervention. Depending upon module configuration, the priority changes between the generators based on engine hours or an internal dual mutual timer.

### 6.1.1 BALANCING MODE: SET PRIORITY

#### Highest Priority



#### Next Highest Priority



Dual Mutual Standby

Dual Mutual Standby

Balancing Mode

Start On Current (Amps) Alarms

Duty Time

Dual Mutual Comms Port

Dual Mutual Standby

Dual Mutual Standby

Balancing Mode

Start On Current (Amps) Alarms

Duty Time

Dual Mutual Comms Port

GenSet

MSC ID	1	<input type="text" value="1"/>	<input type="button" value="Set"/>
Priority	1	<input type="text" value="1"/>	<input type="button" value="Set"/>

GenSet

MSC ID	2	<input type="text" value="2"/>	<input type="button" value="Set"/>
Priority	2	<input type="text" value="2"/>	<input type="button" value="Set"/>

If a starting request is made, the starting sequence begins. Starting requests are made from the following sources:

- Activation of a digital input that has been configured to *Remote Start On Load*:
  - The *Remote Start On Load* signal (connected to a digital input on both modules) controls the starting/stopping of both modules when they are in **Auto Mode** . In this instance, the *Highest Priority* starts its generator. If the *Highest Priority* fails, it instructs the *Next Highest Priority* to start and take the load using the digital communications link.
  - If the *Highest Priority* is running and the *Remote Start Signal On Load* signal is given to the *Next Highest Priority*, the *Next Highest Priority* does not start its generator until the *Highest Priority* generator fails.
- Activation of the inbuilt scheduler:
  - In the *Dual Mutual Standby* operation, the inbuilt scheduler operates totally independently to the *Priority* scheme. Both generators could start, but only the *Highest Priority* can close its load switch to power the load.

## 6.1.2 BALANCING MODE: ENGINE HOURS/DUAL MUTUAL TIME

### Highest Priority



### Next Highest Priority



Dual Mutual Standby

Dual Mutual Standby

Balancing Mode

Start On Current (Amps) Alarms

Duty Time

Dual Mutual Comms Port

GenSet

MSC ID	1	<input type="text" value="1"/>	<input type="button" value="Set"/>
Priority	1	<input type="text" value="1"/>	<input type="button" value="Set"/>

Dual Mutual Standby

Dual Mutual Standby

Balancing Mode

Start On Current (Amps) Alarms

Duty Time

Dual Mutual Comms Port

GenSet

MSC ID	2	<input type="text" value="2"/>	<input type="button" value="Set"/>
Priority	2	<input type="text" value="2"/>	<input type="button" value="Set"/>

If a starting request is made, the starting sequence begins. Starting requests are made from the following sources:

- Activation of a digital input that has been configured to *Remote Start On Load*:
  - The *Remote Start On Load* signal (connected to a digital input on both modules) controls the starting/stopping of both modules when they are in **Auto Mode** . In this instance, the generator with the lowest number of *Engine Hours* or *Dual Mutual Time* starts. If all generators have the same number of *Engine Hours* or *Dual Mutual Time*, the highest *Priority* starts. If the generator with the lowest number of *Engine Hours* or *Dual Mutual Time* fails, it instructs the next generator with the lowest number of *Engine Hours* or *Dual Mutual Time* to start and take the load using the digital communications link.
  - If a generator is running and the *Remote Start Signal On Load* signal is given to another generator with a lower number *Engine Hours* or *Dual Mutual Time*, it does not start until the generator fails. If the running generator's *Engine Hours* or *Dual Mutual Time* is greater than other generators by the configured *Duty Time*, it instructs the next generator with the lowest number of *Engine Hours* or *Dual Mutual Time* to start and take the load using the digital communications link.
- Activation of the inbuilt scheduler:
  - In the *Dual Mutual Standby* operation, the inbuilt scheduler operates totally independently to the *Engine Hours* or *Dual Mutual Time* scheme. Both generators could start, but only the generator with the lowest number of *Engine Hours* or *Dual Mutual Time* can close its load switch to power the load.



## 6.2 USING TWO DSE7320 MKII

 **NOTE: In all operating modes, only one DSE7320 MKII is permitted to close a generator load switching device at any time.**

 **NOTE: In all operating modes, only one DSE7320 MKII is permitted to operate the mains load switching device at any time.**

 **NOTE: Mechanical and/or electrical interlocks between all the load switches is required.**

When using the two DSE7320 MKII modules, one on each generator, the *Dual Mutual Standby* feature allows a priority generator to be backed up whilst also backing up a mains supply. The generators starting and stopping to achieve this occurs automatically with no user intervention. The priority can be configured change between the generators based on engine hours or an internal dual mutual timer. The DSE7320 MKII which controls the mains load switch is the one which has the highest priority in that instant or whose generator is running on load.

## 6.2.1 BALANCING MODE: SET PRIORITY

### Highest Priority



### Next Highest Priority



Dual Mutual Standby

Dual Mutual Standby

Balancing Mode

Start On Current (Amps) Alarms

Duty Time

Dual Mutual Comms Port

Dual Mutual Standby

Dual Mutual Standby

Balancing Mode

Start On Current (Amps) Alarms

Duty Time

Dual Mutual Comms Port



GenSet

MSC ID	1	<input type="text" value="1"/>	<input type="button" value="Set"/>
Priority	1	<input type="text" value="1"/>	<input type="button" value="Set"/>

GenSet

MSC ID	2	<input type="text" value="2"/>	<input type="button" value="Set"/>
Priority	2	<input type="text" value="2"/>	<input type="button" value="Set"/>

If a starting request is made, the starting sequence begins. Starting requests are made from the following sources:

- No activation of a digital input configured to *Remote Start On Load* or no *Mains Failure Detection*:
  - If the *Highest Priority* module is not in the **Stop/Reset Mode**  or does not have an *Electrical Trip Alarm* or *Shutdown Alarm* active, it controls the mains load switch by activating the required close or open signal. The other module ensures its close and open signals are turned off, so no conflicting control signals are sent to the mains load switch.
  - If the *Highest Priority* module is in the **Stop/Reset Mode**  or has an *Electrical Trip Alarm* or *Shutdown Alarm* active, it passes control of the mains load switch to *Next Highest Priority*. The *Next Highest Priority* activates the required close or open signal prior to the *Highest Priority* de-activating its control signal. This is done to ensure that the mains load switch is maintained in the required position whilst changing over control between the modules.
- Activation of a digital input configured to *Remote Start On Load* or *Mains Failure Detection*:
  - The *Remote Start On Load* signal (connected to a digital input on both modules) or *Mains Failure* detection (loss of mains sensing on both modules) controls the starting/stopping of both modules when they are in **Auto Mode** . In this instance, the *Highest Priority* starts its generator. If the *Highest Priority* generator fails to start, control is passed to the *Next Highest Priority* using the digital communications link. The *Next Highest Priority* takes control of the mains load switch and starts its generator. Once the generator is available, the load is then transferred.
  - If the *Highest Priority* is running and the *Remote Start Signal On Load* signal or *Mains Failure* detection occurs on the *Next Highest Priority*, the *Next Highest Priority* does not attain control nor start its generator until the *Highest Priority* generator fails.
- Activation of the inbuilt scheduler:
  - In the *Dual Mutual Standby* operation, the inbuilt scheduler operates totally independently to the *Priority* scheme. Both generators could start, but only the *Highest Priority* can control the mains load switch and transfer the load to its generator.

## 6.2.2 BALANCING MODE: ENGINE HOURS/DUAL MUTUAL TIME

### Highest Priority



### Next Highest Priority





Dual Mutual Standby	
Dual Mutual Standby	Always
Balancing Mode	Engine Hours
Start On Current (Amps) Alarms	<input type="checkbox"/>
Duty Time	8h
Dual Mutual Comms Port	RS485 Por

Dual Mutual Standby	
Dual Mutual Standby	Always
Balancing Mode	Engine Hours
Start On Current (Amps) Alarms	<input type="checkbox"/>
Duty Time	8h
Dual Mutual Comms Port	RS485 Por

GenSet			
MSC ID	1	1	Set
Priority	1	1	Set

GenSet			
MSC ID	2	2	Set
Priority	2	2	Set

If a starting request is made, the starting sequence begins. Starting requests are made from the following sources:

- No activation of a digital input configured to *Remote Start On Load* or no *Mains Failure Detection*:
  - If the module with the lowest number of *Engine Hours* or *Dual Mutual Time* is not in the **Stop/Reset Mode**  or, does not have an *Electrical Trip / Shutdown Alarm* active, it controls the mains load switch by activating the required close or open signal. The other module ensures its close and open signals are turned off, so no conflicting control signals are sent to the mains load switch.
  - If the module with the lowest number of *Engine Hours* or *Dual Mutual Time* is in the **Stop/Reset Mode**  or, has an *Electrical Trip / Shutdown Alarm* active, it passes control of the mains load switch to the next generator with the lowest number of *Engine Hours* or *Dual Mutual Time*. The next generator with the lowest number of *Engine Hours* or *Dual Mutual Time* activates the required close or open signal prior to generator with the lowest number of *Engine Hours* or *Dual Mutual Time* de-activating its control signal. This is done to ensure that the mains load switch is maintained in the required position whilst changing over control between the modules.

## Operation

- Activation of a digital input configured to *Remote Start On Load* or *Mains Failure Detection*:
  - The *Remote Start On Load* signal (connected to a digital input on both modules) or *Mains Failure* detection (loss of mains sensing on both modules) controls the starting/stopping of both modules when they are in **Auto Mode** . In this instance, the module with the lowest number of *Engine Hours* or *Dual Mutual Time* starts its generator. If the module with the lowest number of *Engine Hours* or *Dual Mutual Time* generator fails to start, control is passed to the next generator with the lowest number of *Engine Hours* or *Dual Mutual Time* using the digital communications link. The next generator with the lowest number of *Engine Hours* or *Dual Mutual Time* takes control of the mains load switch and starts its generator. Once the generator is available, the load is then transferred.
  - If the module with the lowest number of *Engine Hours* or *Dual Mutual Time* generator is running and the *Remote Start Signal On Load* signal or *Mains Failure* detection occurs on the next generator with the lowest number of *Engine Hours* or *Dual Mutual Time*, it does not attain control or start its generator until module with the running generator fails.
- Activation of the inbuilt scheduler:
  - In the *Dual Mutual Standby* operation, the inbuilt scheduler operates totally independently to the *Engine Hours* or *Dual Mutual Time* scheme. Both generators could start, but only the with the lowest number of *Engine Hours* or *Dual Mutual Time* can control the mains load switch and transfer the load to its generator.

## 7 PROTECTIONS

### 7.1 ALARMS

When an alarm is active, the *Internal Audible Alarm* sounds and the *Common Alarm* output if configured, activates.

The audible alarm is silenced by pressing the **Alarm Mute / Lamp Test**  button.

The LCD display jumps from the 'Information page' to display the Alarm Page

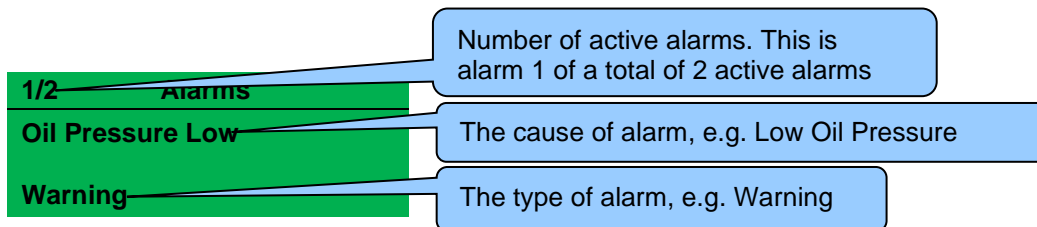

The LCD displays multiple alarms such as "*Coolant Temperature High*", "*Emergency Stop*" and "*Low Coolant Warning*". These automatically scroll in the order that they occurred or press the

**Instrumentation Scroll**  buttons to scroll through manually.

In the event of an alarm, the LCD displays the appropriate text. If an additional alarm then occurs, the module displays the appropriate text.

**Example:**

1/2	Alarms
	Oil Pressure Low
	Warning

2/2	Alarms
	Coolant Temp High
	Shutdown

### 7.1.1 PROTECTIONS DISABLED

User configuration is possible to prevent *Shutdown* and *Electrical Trip* alarms from stopping the generator. Under such conditions, *Protections Disabled* appears on the module display to inform the operator. *Shutdown* and *Electrical Trip* alarms still appear however, the operator is informed the alarms are blocked.

**Example:**

1/1	Alarms
Oil Pressure Low	
Shutdown Blocked	

This feature is provided to assist the system designer in meeting specifications for *Warning Only*, *Protections Disabled*, *Run to Destruction*, *War Mode*, or other similar wording.

When configuring this feature in the PC software, the system designer chooses to make the feature permanently active or only active upon operation of an external switch. The system designer provides this switch (not DSE), so its location varies depending upon manufacturer, however it normally takes the form of a key operated switch to prevent inadvertent activation. Depending upon configuration, a warning alarm may be generated when the switch is operated.

The feature is configurable in the PC configuration software for the module. Writing a configuration to the controller that has "Protections Disabled" configured, results in a warning message appearing on the PC screen for the user to acknowledge before the controller's configuration is changed. This prevents inadvertent activation of the feature.

### 7.1.2 ECU ALARMS (CAN FAULT CODES / DTC)

**NOTE:** For details on these code meanings, refer to the ECU instructions provided by the engine manufacturer, or contact the engine manufacturer for further assistance.

**NOTE:** For further details on connection to electronic engines, refer to DSE Publication: **057-004 Electronic Engines And DSE Wiring**

When connected to a suitable CAN engine, the controller displays alarm status messages from the ECU in the *Alarms* section of the display.

<b>1/1</b>	<b>Alarms</b>
<b>ECU Warning</b>	
<b>Warning</b>	

Type of alarm that is triggered on the DSE module, e.g. Warning

Press the **Next Page**  button to access the list of *ECU Current DTCs* (Diagnostic Trouble Codes) from the ECU which are DM1 messages.

<b>1/2</b>	<b>ECU Current DTCs</b>
<b>Water Level Low</b>	
<b>SPN=131166 , FMI=8, OC=127</b>	

The DM1 DTC is interpreted by the module and is shown on the module's display as a text message. In addition to this, the manufacturer's DTC is shown below.

Press the **Next Page**  button to access the list of *ECU Prev. DTCs* (Diagnostic Trouble Codes) from the ECU which are DM2 messages.

<b>1/10</b>	<b>ECU Prev. DTCs</b>
<b>Water Level Low</b>	
<b>SPN=131166 , FMI=8, OC=127</b>	

The DM2 DTC is interpreted by the module and is shown on the module's display as a text message. In addition to this, the manufacturer's DTC is shown below.

## 7.2 INDICATIONS

Indications are non-critical and often status conditions. They do not appear on the LCD display of the module as a text message in the *Status*, *Event Log* or *Alarms* pages. However, an output or LED indicator is configured to draw the operator's attention to the event.

### Example:

- Input configured for indication.
- The LCD text does not appear on the module display but can be added in the configuration to remind the system designer what the input is used for.
- As the input is configured to *Indication* there is no alarm generated.
- LED Indicator 1 illuminates when Digital Input A is active.
- The Insert Card Text allows the system designer to print an insert card detailing the LED function.
- Example showing operation of the LED.

Digital Input A

Function: User Configured

Polarity: Open to Activate

Action: Indication

Arming: Always

LCD Display: Panel Door Open

Activation Delay: 0s

LED Indicators

1	Digital Input A	Lit
2	Common Warning	Lit
3	Common Shutdown	Lit
4	Common Electrical Trip	Lit

Insert Card Text: Panel Door Open

Buttons: Text Insert, Logo Insert





### 7.3 WARNING ALARMS

Warnings are non-critical alarm conditions and do not affect the operation of the engine system, they serve to draw the operator’s attention to an undesirable condition.

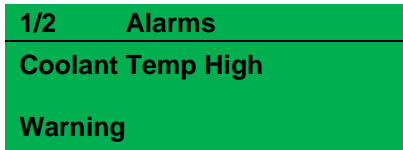

Example:



In the event of an alarm the LCD jumps to the alarms page and scroll through all active alarms.

By default, warning alarms are self-resetting when the fault condition is removed. However, enabling *All Warnings Are Latched* causes warning alarms to latch until reset manually. This is enabled using the DSE Configuration Suite in conjunction with a compatible PC.

If the module is configured for **CAN** and receives an “error” message from the ECU, ‘ECU Warning’ is shown on the module’s display as a warning alarm.

Fault	Description
2130 ID 0 to 3 Analogue Input E to H High	<p> <b>NOTE: Due to module configuration the alarm message that appears on the display may be different. For further details of module configuration, refer to DSE Publication: 057-243 DSE7310 MKII &amp; DSE7320 MKII Configuration Software Manual.</b></p> <p>The module detected that an analogue input value of a DSE2130 had risen above the <i>Flexible Sensor High Pre-Alarm Trip</i> level.</p>
2130 ID 0 to 3 Analogue Input E to H Low	<p> <b>NOTE: Due to module configuration the alarm message that appears on the display may be different. For further details of module configuration, refer to DSE Publication: 057-243 DSE7310 MKII &amp; DSE7320 MKII Configuration Software Manual.</b></p> <p>The module detected that an analogue input value of a DSE2130 had fallen below the <i>Flexible Sensor Low Pre-Alarm Trip</i> level.</p>
2130 ID 0 to 3 Digital Input A to H	<p> <b>NOTE: Due to module configuration the alarm message that appears on the display may be different. For further details of module configuration, refer to DSE Publication: 057-243 DSE7310 MKII &amp; DSE7320 MKII Configuration Software Manual.</b></p> <p>The module detected that a digital input configured to create a fault condition on a DSE2130 expansion module became active and the appropriate LCD message displayed.</p>

Continued over page...

Fault	Description
DSE2131 ID 0 to 3 Analogue Input A to J High	<p><b>▲ NOTE:</b> Due to module configuration the alarm message that appears on the display may be different. For further details of module configuration, refer to DSE Publication: <i>057-243 DSE7310 MKII &amp; DSE7320 MKII Configuration Software Manual</i>.</p> <p>The module detected that an analogue input value of a DSE2131 had risen above the <i>Flexible Sensor High Pre-Alarm Trip</i> level.</p>
DSE2131 ID 0 to 3 Analogue Input A to J Low	<p><b>▲ NOTE:</b> Due to module configuration the alarm message that appears on the display may be different. For further details of module configuration, refer to DSE Publication: <i>057-243 DSE7310 MKII &amp; DSE7320 MKII Configuration Software Manual</i>.</p> <p>The module detected that an analogue input value of a DSE2131 had fallen below the <i>Flexible Sensor Low Pre-Alarm Trip</i> level.</p>
DSE2131 ID 0 to 3 Digital Input A to J	<p><b>▲ NOTE:</b> Due to module configuration the alarm message that appears on the display may be different. For further details of module configuration, refer to DSE Publication: <i>057-243 DSE7310 MKII &amp; DSE7320 MKII Configuration Software Manual</i>.</p> <p>The module detected that a digital input configured to create a fault condition on a DSE2131 expansion module became active and the appropriate LCD message displayed.</p>
DSE2133 ID 0 to 3 Analogue Input A to H High	<p><b>▲ NOTE:</b> Due to module configuration the alarm message that appears on the display may be different. For further details of module configuration, refer to DSE Publication: <i>057-243 DSE7310 MKII &amp; DSE7320 MKII Configuration Software Manual</i>.</p> <p>The module detected that an analogue input value of a DSE2133 had risen above the <i>Temperature Sensor High Pre-Alarm Trip</i> level.</p>
DSE2133 ID 0 to 3 Analogue Input A to H Low	<p><b>▲ NOTE:</b> Due to module configuration the alarm message that appears on the display may be different. For further details of module configuration, refer to DSE Publication: <i>057-243 DSE7310 MKII &amp; DSE7320 MKII Configuration Software Manual</i>.</p> <p>The module detected that an analogue input value of a DSE2133 had fallen below the <i>Temperature Sensor Low Pre-Alarm Trip</i> level.</p>
Charger ID 0 to 3 Common Warning	<p><b>▲ NOTE:</b> Due to module configuration the alarm message that appears on the display may be different. For further details of module configuration, refer to DSE Publication: <i>057-243 DSE7310 MKII &amp; DSE7320 MKII Configuration Software Manual</i>.</p> <p>The module detected that a battery charger connected by DSENet® had issued a <i>Common Warning Alarm</i>.</p>

Fault	Description
Analogue Input A to F (Digital)	<p> <b>NOTE: Due to module configuration the alarm message that appears on the display may be different. For further details of module configuration, refer to DSE Publication: 057-243 DSE7310 MKII &amp; DSE7320 MKII Configuration Software Manual.</b></p> <p>The module detected that an analogue input configured as a digital input to create a fault condition became active and the appropriate LCD message is displayed.</p>
AVR Data Fail	The module is configured to communicate to the generator's AVR by CAN but has not detected data being sent from the generator's AVR.
AVR Fault	The module received a red fault condition from the alternators AVR.
Battery Detect Failure	The module detected that a battery charger connected by DSENet <sup>®</sup> had issued a <i>Battery Detect Failure</i> alarm.
Battery Failure Detection Output 1	The module detected that a battery charger connected by DSENet <sup>®</sup> had issued a <i>Battery Failure Detection</i> alarm on its Output 1.
Battery Failure Detection Output 2	The module detected that a battery charger connected by DSENet <sup>®</sup> had issued a <i>Battery Failure Detection</i> alarm on its Output 2.
Battery High Current Output 1	The module detected that a battery charger connected by DSENet <sup>®</sup> had issued a <i>Battery High Current</i> alarm on its Output 1.
Battery High Current Output 2	The module detected that a battery charger connected by DSENet <sup>®</sup> had issued a <i>Battery High Current</i> alarm on its Output 2.
Battery High Temperature Output 1	The module detected that a battery charger connected by DSENet <sup>®</sup> had issued a <i>Battery High Temperature</i> alarm on its Output 1.
Battery High Temperature Output 2	The module detected that a battery charger connected by DSENet <sup>®</sup> had issued a <i>Battery High Temperature</i> alarm on its Output 2.
Battery High Voltage Output 1	The module detected that a battery charger connected by DSENet <sup>®</sup> had issued a <i>Battery High Voltage</i> alarm on its Output 1.
Battery High Voltage Output 2	The module detected that a battery charger connected by DSENet <sup>®</sup> had issued a <i>Battery High Voltage</i> alarm on its Output 2.
Battery Low Voltage Output 1	The module detected that a battery charger connected by DSENet <sup>®</sup> had issued a <i>Battery Low Voltage</i> alarm on its Output 1.
Battery Low Voltage Output 2	The module detected that a battery charger connected by DSENet <sup>®</sup> had issued a <i>Battery Low Voltage</i> alarm on its Output 2.
Battery Temperature Sensor Fail Output 1	The module detected that a battery charger connected by DSENet <sup>®</sup> had issued a <i>Battery Temperature Fail</i> alarm on its Output 1.
Battery Temperature Sensor Fail Output 2	The module detected that a battery charger connected by DSENet <sup>®</sup> had issued a <i>Battery Temperature Fail</i> alarm on its Output 2.
Calibration Fault	The module detected that its internal calibration has failed. The unit must be sent back to DSE to be investigated and repaired. Contact DSE Technical Support for more details.
Charge Alt Failure IEEE 37.2 – 27 DC Undervoltage Relay	The module detected that the output voltage of the charge alternator had fallen below the <i>Charge Alternator Warning Trip</i> level for the configured delay timer.
Charger Fan Locked	The module detected that a battery charger connected by DSENet <sup>®</sup> had a <i>Failure</i> alarm.
Charger High Temperature	The module detected that a battery charger connected by DSENet <sup>®</sup> had a <i>High Temperature</i> alarm.

*Protections*

Charger Mains High Current	The module detected that a battery charger connected by DSENet® had a <i>Mains High Current</i> alarm.
Charger Mains High Voltage	The module detected that a battery charger connected by DSENet® had a <i>Mains High Voltage</i> alarm.

Continued over page...

Fault	Description
Charger Mains Low Voltage	The module detected that a battery charger connected by DSENet® had a <i>Mains Low Voltage</i> alarm.
Charger Voltage Drop Charging Cable Output 1	The module detected that a battery charger connected by DSENet® had issued a <i>Voltage Drop Charging Cable</i> alarm on its Output 1.
Charger Voltage Drop Charging Cable Output 2	The module detected that a battery charger connected by DSENet® had issued a <i>Voltage Drop Charging Cable</i> alarm on its Output 2.
Coolant Temp High IEEE C37.2 – 26 Apparatus Thermal Device	The module detected that the engine coolant temperature had risen above the <i>High Coolant Temperature Pre-Alarm Trip</i> level after the <i>Safety On Delay</i> timer had expired.
DC Battery High Voltage IEEE 37.2 – 59 DC Overvoltage Relay	The module detected that its DC supply voltage had risen above the <i>Plant Battery Overvolts Warning Trip</i> level for the configured delay timer.
DC Battery Low Voltage IEEE 37.2 – 27 DC Undervoltage Relay	The module detected that its DC supply voltage had fallen below the <i>Plant Battery Undervolts Warning Trip</i> level for the configured delay timer.
DEF Level Low	The module received a fault condition from the engine ECU alerting about the DEF level or the module detected that the <i>DEF Level</i> had fallen below the <i>DEF Level Low Pre-Alarm Trip</i> level for the configured delay timer.
Digital Input A to H	<div style="border: 1px solid black; padding: 5px; margin-bottom: 10px;"> <p><b>▲ NOTE: Due to module configuration the alarm message that appears on the display may be different. For further details of module configuration, refer to DSE Publication: 057-243 DSE7310 MKII &amp; DSE7320 MKII Configuration Software Manual.</b></p> </div> <p>The module detected that a digital input configured to create a fault condition became active and the appropriate LCD message is displayed.</p>
DPTC Filter	The module received a fault condition from the engine ECU alerting that the DPF/DPTC had activated.
Earth Fault IEEE C37.2 – 51G or 51N Generator IDMT Earth Fault Relay	<div style="border: 1px solid black; padding: 5px; margin-bottom: 10px;"> <p><b>▲ NOTE: For more details, see section 7.9 entitled Earth Fault IDMT Alarm in this document.</b></p> </div> <p>The module detected that the generator earth fault current had risen above the <i>Earth Fault Trip Level</i> for the duration of the IDMT function.</p>
ECU Amber	The module received an amber fault condition from the engine ECU.
ECU Data Fail	The module is configured for CAN operation but has not detected data being sent from the engine's ECU.
ECU Malfunc.	The module received a malfunction fault condition from the engine ECU.
ECU Protect	The module received a protect fault condition from the engine ECU.
ECU Red	The module received a red fault condition from the engine ECU.
Engine Over Speed IEEE C37.2 - 12 Overspeed Device	The module detected that the engine speed had risen above the <i>Over Speed Pre-Alarm Trip</i> level for the configured delay timer.
Engine Over Speed Delayed IEEE C37.2 - 12 Overspeed Device	The module detected that the engine speed had risen above the <i>Over Speed Trip</i> level but was below the <i>Over Speed Overshoot Trip</i> for the configured <i>Overshoot Delay</i> timer during starting.
Engine Under Speed IEEE C37.2 - 14 Underspeed Device	The module detected that the engine speed had fallen below the <i>Under Speed Pre-Alarm Trip</i> level for the configured delay timer after the <i>Safety On Delay</i> timer had expired.

*Protections*

Escape Mode	The module detected that an <i>Escape Mode</i> request has been sent to the engine ECU.
Exp. Unit Failure	The module detected that communications to one of the DSENet® expansion modules had been lost.

Continued over page...



Fault	Description
Fail to Synchronise	The module failed to synchronise the generator to the mains before the <i>Fail to Sync Delay</i> timer had expired. The generator continues to run until it has successfully synchronised to the mains.
Flexible Sensor A to F High	<div data-bbox="587 353 1390 539" style="border: 1px solid black; padding: 5px;"> <p><b>▲ NOTE: Due to module configuration the alarm message that appears on the display may be different. For further details of module configuration, refer to DSE Publication: 057-243 DSE7310 MKII &amp; DSE7320 MKII Configuration Software Manual.</b></p> </div> <p>The module detected that an analogue input value had risen above the <i>Flexible Sensor High Pre-Alarm Trip</i> level.</p>
Flexible Sensor A to F Low	<div data-bbox="587 638 1390 824" style="border: 1px solid black; padding: 5px;"> <p><b>▲ NOTE: Due to module configuration the alarm message that appears on the display may be different. For further details of module configuration, refer to DSE Publication: 057-243 DSE7310 MKII &amp; DSE7320 MKII Configuration Software Manual.</b></p> </div> <p>The module detected that an analogue input value had fallen below the <i>Flexible Sensor Low Pre-Alarm Trip</i> level.</p>
Fuel Level High IEEE C37.2 - 71 Liquid Level Switch	The module detected that the engine fuel level rose above the <i>High Fuel Level Trip</i> level.
Fuel Level Low IEEE C37.2 - 71 Liquid Level Switch	The module detected that the engine fuel level had fallen below the <i>Low Fuel Level Trip</i> level.
Fuel Level Low Switch IEEE C37.2 - 71 Liquid Level Switch	The module detected that the engine low fuel level switch had activated.
Fuel Tank Bund Level High IEEE C37.2 - 71 Liquid Level Switch	The module detected that the fuel tank bund level switch had activated.
Fuel Usage IEEE C37.2 - 80 Flow Switch	The module detected that the fuel consumption was more than the configured <i>Running Rate</i> or <i>Stopped Rate</i> .
Gen Failed to Close IEEE C37.2 - 52b AC Circuit Breaker Position (Contact Open when Breaker Closed)	The module detected that the generator load switch had failed to close as the Generator Closed Auxiliary input did not activate within the Generator Fail to Close Delay time after the Close Gen Output activated.
Gen Failed to Open IEEE C37.2 - 52b AC Circuit Breaker Position (Contact Open when Breaker Closed)	The module detected that the generator load switch had failed to open as the Generator Closed Auxiliary input did not deactivate within the Generator Fail to Open Delay time after the Close Gen Output deactivated.
Gen Loading Voltage	The module detected that the generator output voltage had not risen above the <i>Generator Loading Voltage</i> setting after the <i>Warming Up</i> timer had expired.
Gen Over Current IEEE C37.2 - 50 Instantaneous Overcurrent Relay IEEE C37.2 - 51 IDMT Overcurrent Relay	<div data-bbox="587 1574 1390 1671" style="border: 1px solid black; padding: 5px;"> <p><b>▲ NOTE: For more details, see section 7.7 entitled Over Current Alarm in this document.</b></p> </div> <p>The module detected that the generator output current had risen above the <i>Generator Over Current Trip</i>.</p>
Gen Over Frequency IEEE C37.2 - 81 Frequency Relay	The module detected that the generator output frequency had risen above the <i>Over Frequency Pre-Alarm Trip</i> level for the configured delay timer.
Gen Over Frequency Delayed IEEE C37.2 - 81 Frequency Relay	The module detected that the generator output frequency had risen above the <i>Over Frequency Trip</i> level but was below the <i>Over Frequency Overshoot Trip</i> for the configured <i>Overshoot Delay</i> timer during starting.

*Protections*

<p>Gen Over Voltage IEEE C37.2 – 59 AC Overvoltage Relay</p>	<p>The module detected that the generator output voltage had risen above the <i>Over Voltage Pre-Alarm Trip</i> level for the configured delay timer.</p>
--	---

Continued over page...



Fault	Description
Gen Reverse Power IEEE C37.2 – 32 Directional Power Relay	The module detected that the generator output kW had fallen below the <i>Reverse Power Trip</i> for the configured delay timer.
Gen Short Circuit IEEE C37.2 – 51 IDMT Short Circuit Relay	<div style="border: 1px solid black; padding: 5px;">  <b>NOTE: For more details, see section 7.8 entitled <i>Short Circuit IDMT Alarm</i> in this document.</b> </div> <p>The module detected that the generator output current had risen above the <i>Short Circuit Trip</i> for the duration of the IDMT function.</p>
Gen Under Frequency IEEE C37.2 – 81 Frequency Relay	The module detected that the generator output frequency had fallen below the <i>Under Frequency Pre-Alarm Trip</i> level for the configured delay timer after the <i>Safety On Delay</i> timer had expired.
Gen Under Voltage IEEE C37.2 – 27 AC Undervoltage Relay	The module detected that the generator output voltage had fallen below the <i>Under Voltage Pre-Alarm Trip</i> level for the configured delay timer after the <i>Safety On Delay</i> timer had expired.
HEST Active	The module received a fault condition from the engine ECU alerting that the HEST had activated.
Inlet Temperature	The module detected that the engine's ECU measurement of inlet temperature had risen above the <i>Inlet Temperature Alarm Pre-Alarm Trip</i> level.
kW Overload IEEE C37.2 – 32 Directional Power Relay	The module detected that the generator output kW had risen above the <i>Overload Protection Trip</i> for the configured delay timer
Loss of Mag-PU	The module detected that the magnetic pick up was not producing a pulse output after the required <i>Crank Disconnect</i> criteria had been met.
Low Coolant Warning	The module detected that the engine coolant temperature had fallen below the <i>Low Coolant Temperature Pre-Alarm Trip</i> level.
Low Load IEEE C37.2 – 37 Undercurrent of Underpower relay	The module detected that the load had fallen below the <i>Low Load Alarm Trip</i> level.
Mains Earth Fault IEEE C37.2 – 51 IDMT Overcurrent Relay	<div style="border: 1px solid black; padding: 5px;">  <b>NOTE: For more details, see section 7.9 entitled <i>Earth Fault IDMT Alarm</i> in this document.</b> </div>
	<div style="border: 1px solid black; padding: 5px;">  <b>NOTE: Mains current protection is only available when the CT location is set for <i>Load</i>. For further details of module configuration, refer to DSE Publication: <i>057-243 DSE7310 MKII &amp; DSE7320 MKII Configuration Software Manual</i>.</b> </div> <p>The module detected that the generator earth fault current had risen above the <i>Mains Earth Fault Trip Level</i> for the duration of the IDMT function.</p>
Mains Failed to Close IEEE C37.2 – 52b AC Circuit Breaker Position (Contact Open when Breaker Closed)	The module detected that the mains load switch had failed to close as the Mains Closed Auxiliary input did not activate within the Mains Fail to Close Delay time after the Close Mains Output activated.
Mains Failed to Open IEEE C37.2 – 52b AC Circuit Breaker Position (Contact Open when Breaker Closed)	The module detected that the mains load switch had failed to open as the Mains Closed Auxiliary input did not deactivate within the Mains Fail to Open Delay time after the Close Mains Output deactivated.

Continued over page...

Fault	Description
Mains Over Current IEEE C37.2 – 50 Instantaneous Overcurrent Relay IEEE C37.2 – 51 IDMT Overcurrent Relay	<p><b>▲ NOTE:</b> For more details, see section 7.7 entitled <i>Over Current Alarm</i> in this document.</p> <p><b>▲ NOTE:</b> Mains current protection is only available when the CT location is set for <i>Load</i>. For further details of module configuration, refer to DSE Publication: <i>057-262 DSE7410 MKII &amp; DSE7420 MKII Configuration Software Manual</i>.</p> <p>The module detected that the mains output current had risen above the <i>Mains Over Current Trip</i>.</p>
Mains Phase Seq Wrong	<p>The module detected that the phase rotation of the mains was different to the configured <i>Mains Phase Rotation Alarm</i> setting.</p>
Mains Short Circuit IEEE C37.2 – 51 IDMT Short Circuit Relay	<p><b>▲ NOTE:</b> For more details, see section 7.8 entitled <i>Short Circuit IDMT Alarm</i> in this document.</p> <p><b>▲ NOTE:</b> Mains current protection is only available when the CT location is set for <i>Load</i>. For further details of module configuration, refer to DSE Publication: <i>057-243 DSE7310 MKII &amp; DSE7320 MKII Configuration Software Manual</i>.</p> <p>The module detected that the mains output current had risen above the <i>Short Circuit Trip</i> for the duration of the IDMT function.</p>
Maintenance Due	<p><b>▲ NOTE:</b> Due to module configuration the alarm message that appears on the display may be different. For further details of module configuration, refer to DSE Publication: <i>057-243 DSE7310 MKII &amp; DSE7320 MKII Configuration Software Manual</i>.</p> <p>The module detected that one of the configured maintenance alarms is due as its configured maintenance interval has expired.</p>
MSC Failure	<p>The module detected that <i>Dual Mutual Standby</i> communication link had failed.</p>
Negative kvar IEEE C37.2 – 40 Field Under Excitation Relay	<p>The module detected that the generator output kvar had fallen below the <i>Negative var Pre-Alarm Trip</i> for the configured delay timer.</p>
Negative Phase Sequence IEEE C37.2 - 46 Phase-Balance Current Relay	<p>The module detected that there was an imbalance of current across the generator phases greater than the <i>Negative Phase Sequence Trip Level</i> percentage setting.</p>
Oil Pressure Low IEEE C37.2 - 63 Pressure Switch	<p>The module detected that the engine oil pressure had fallen below the <i>Low Oil Pressure Pre-Alarm Trip</i> level after the <i>Safety On Delay</i> timer had expired.</p>
Positive kvar IEEE C37.2 – 40 Field Over Excitation Relay	<p>The module detected that the generator output kvar had risen above the <i>Positive var Pre-Alarm Trip</i> for the configured delay timer.</p>
Protections Disabled	<p>The module detected that an input configured for Protections Disable became active.</p>
SCR Inducement	<p>The module received a fault condition from the engine ECU alerting about the SCR Inducement.</p>
Water in Fuel	<p>The module received a fault condition from the engine ECU alerting that water in the fuel had been detected.</p>

## 7.4 ELECTRICAL TRIP ALARMS

**NOTE:** The fault condition must be resolved before the alarm can be reset. If the fault condition remains, it is not possible to reset the alarm (the exception to this is the *Coolant Temp High* alarm and similar *Active From Safety On* alarms, as the coolant temperature could be high with the engine at rest).

Electrical Trip Alarms are latching and stop the Generator but in a controlled manner. On initiation of the electrical trip condition the module de-activates the **Close Gen Output** outputs to remove the load from the generator. Once this has occurred the module starts the *Cooling Timer* and allows the engine to cool off-load before shutting down the engine. To restart the generator the fault must be cleared, and the alarm reset.

**Example:**

1/2 Alarms
Gen Over Current
Electrical Trip

In the event of an alarm the LCD jumps to the alarms page and scrolls through all active alarms.

Electrical Trip Alarms are latching alarms and to remove the fault, press the **Stop/Reset Mode**  button on the module.

Fault	Description
2130 ID 1 to 4 Analogue Input E to H High	<p><b>NOTE:</b> Due to module configuration the alarm message that appears on the display may be different. For further details of module configuration, refer to DSE Publication: <i>057-243 DSE7310 MKII &amp; DSE7320 MKII Configuration Software Manual</i>.</p> <p>The module detected that an analogue input value of a DSE2130 had risen above the <i>Flexible Sensor High Alarm Trip</i> level.</p>
2130 ID 1 to 4 Analogue Input E to H Low	<p><b>NOTE:</b> Due to module configuration the alarm message that appears on the display may be different. For further details of module configuration, refer to DSE Publication: <i>057-243 DSE7310 MKII &amp; DSE7320 MKII Configuration Software Manual</i>.</p> <p>The module detected that an analogue input value of a DSE2130 had fallen below the <i>Flexible Sensor Low Alarm Trip</i> level.</p>
2130 ID1 to 4 Digital Input A to H	<p><b>NOTE:</b> Due to module configuration the alarm message that appears on the display may be different. For further details of module configuration, refer to DSE Publication: <i>057-243 DSE7310 MKII &amp; DSE7320 MKII Configuration Software Manual</i>.</p> <p>The module detected that a digital input configured to create a fault condition on a DSE2130 expansion module became active and the appropriate LCD message displayed.</p>

Continued over page...

Fault	Description
DSE2131 ID 0 to 3 Analogue Input A to J High	<p><b>▲ NOTE:</b> Due to module configuration the alarm message that appears on the display may be different. For further details of module configuration, refer to DSE Publication: <i>057-243 DSE7310 MKII &amp; DSE7320 MKII Configuration Software Manual</i>.</p> <p>The module detected that an analogue input value of a DSE2131 had risen above the <i>Flexible Sensor High Alarm Trip</i> level.</p>
DSE2131 ID 0 to 3 Analogue Input A to J Low	<p><b>▲ NOTE:</b> Due to module configuration the alarm message that appears on the display may be different. For further details of module configuration, refer to DSE Publication: <i>057-243 DSE7310 MKII &amp; DSE7320 MKII Configuration Software Manual</i>.</p> <p>The module detected that an analogue input value of a DSE2131 had fallen below the <i>Flexible Sensor Low Alarm Trip</i> level.</p>
DSE2131 ID 0 to 3 Digital Input A to J	<p><b>▲ NOTE:</b> Due to module configuration the alarm message that appears on the display may be different. For further details of module configuration, refer to DSE Publication: <i>057-243 DSE7310 MKII &amp; DSE7320 MKII Configuration Software Manual</i>.</p> <p>The module detected that a digital input configured to create a fault condition on a DSE2131 expansion module became active and the appropriate LCD message displayed.</p>
DSE2133 ID 0 to 3 Analogue Input A to H High	<p><b>▲ NOTE:</b> Due to module configuration the alarm message that appears on the display may be different. For further details of module configuration, refer to DSE Publication: <i>057-243 DSE7310 MKII &amp; DSE7320 MKII Configuration Software Manual</i>.</p> <p>The module detected that an analogue input value of a DSE2133 had risen above the <i>Temperature Sensor High Alarm Trip</i> level.</p>
DSE2133 ID 0 to 3 Analogue Input A to H Low	<p><b>▲ NOTE:</b> Due to module configuration the alarm message that appears on the display may be different. For further details of module configuration, refer to DSE Publication: <i>057-243 DSE7310 MKII &amp; DSE7320 MKII Configuration Software Manual</i>.</p> <p>The module detected that an analogue input value of a DSE2133 had fallen below the <i>Temperature Sensor Low Alarm Trip</i> level.</p>
Charger ID 0 to 3 Common Electrical Trip	<p><b>▲ NOTE:</b> Due to module configuration the alarm message that appears on the display may be different. For further details of module configuration, refer to DSE Publication: <i>057-243 DSE7310 MKII &amp; DSE7320 MKII Configuration Software Manual</i>.</p> <p>The module detected that a battery charger connected by DSENet® had issued a <i>Common Electrical Trip Alarm</i>.</p>

Continued over page...

Fault	Description
Analogue Input A to F (Digital)	<p><b>▲ NOTE: Due to module configuration the alarm message that appears on the display may be different. For further details of module configuration, refer to DSE Publication: 057-243 DSE7310 MKII &amp; DSE7320 MKII Configuration Software Manual.</b></p> <p>The module detected that an analogue input configured as a digital input to create a fault condition became active and the appropriate LCD message is displayed.</p>
Auto Sense Fail	The module detected that the output voltage of the generator had risen above the <i>Over Voltage During Auto Sensing Trip</i> level during starting whilst attempting to detect which alternative configuration to use.
AVR Data Fail	The module is configured to communicate to the generator's AVR by CAN but has not detected data being sent from the generator's AVR.
AVR Fault	The module received a red fault condition from the alternators AVR.
Calibration Fault	The module detected that its internal calibration has failed. The unit must be sent back to DSE to be investigated and repaired. Contact DSE Technical Support for more details.
Coolant Temp High <i>IEEE C37.2 – 26 Apparatus Thermal Device</i>	The module detected that the engine coolant temperature had risen above the <i>High Coolant Temperature Electrical Trip</i> level after the <i>Safety On Delay</i> timer had expired.
DEF Level Low	The module received a fault condition from the engine ECU alerting about the DEF level or the module detected that the <i>DEF Level</i> had fallen below the <i>DEF Level Low Alarm Trip</i> level for the configured delay timer.
Digital Input A to H	<p><b>▲ NOTE: Due to module configuration the alarm message that appears on the display may be different. For further details of module configuration, refer to DSE Publication: 057-243 DSE7310 MKII &amp; DSE7320 MKII Configuration Software Manual.</b></p> <p>The module detected that a digital input configured to create a fault condition became active and the appropriate LCD message is displayed.</p>
DPTC Filter	The module received a fault condition from the engine ECU alerting that the DPF/DPTC had activated.
Earth Fault <i>IEEE C37.2 – 51G or 51N Generator IDMT Earth Fault Relay</i>	<p><b>▲ NOTE: For more details, see section 7.9 entitled Earth Fault IDMT Alarm in this document.</b></p> <p>The module detected that the generator earth fault current had risen above the <i>Earth Fault Trip Level</i> for the duration of the IDMT function.</p>
ECU Amber	The module received an amber fault condition from the engine ECU.
ECU Data Fail	The module is configured for CAN operation but has not detected data being sent from the engine's ECU.
ECU Malfunc.	The module received a malfunction fault condition from the engine ECU.
ECU Protect	The module received a protect fault condition from the engine ECU.
ECU Red	The module received a red fault condition from the engine ECU.

*Protections*







Exp. Unit Failure	The module detected that communications to one of the DSENet <sup>®</sup> expansion modules had been lost.
Fail to Synchronise	The module failed to synchronise the generator to the mains before the Fail to Sync Delay timer had expired. A break changeover occurs, and the generator goes into a cooling run.

Continued over page...

Fault	Description
Flexible Sensor A to F High	<p><b>▲ NOTE: Due to module configuration the alarm message that appears on the display may be different. For further details of module configuration, refer to DSE Publication: 057-243 DSE7310 MKII &amp; DSE7320 MKII Configuration Software Manual.</b></p> <p>The module detected that an analogue input value had risen above the <i>Flexible Sensor High Alarm Trip</i> level.</p>
Flexible Sensor A to F Low	<p><b>▲ NOTE: Due to module configuration the alarm message that appears on the display may be different. For further details of module configuration, refer to DSE Publication: 057-243 DSE7310 MKII &amp; DSE7320 MKII Configuration Software Manual.</b></p> <p>The module detected that an analogue input value had fallen below the <i>Flexible Sensor Low Alarm Trip</i> level.</p>
Fuel Level High IEEE C37.2 - 71 Liquid Level Switch	The module detected that the engine fuel level rose above the <i>High Fuel Level Trip</i> level.
Fuel Level Low IEEE C37.2 - 71 Liquid Level Switch	The module detected that the engine fuel level had fallen below the <i>Low Fuel Level Trip</i> level.
Fuel Level Low Switch IEEE C37.2 - 71 Liquid Level Switch	The module detected that the engine low fuel level switch had activated.
Fuel Tank Bund Level High IEEE C37.2 - 71 Liquid Level Switch	The module detected that the fuel tank bund level switch had activated.
Fuel Usage IEEE C37.2 – 80 Flow Switch	The module detected that the fuel consumption was more than the configured Running Rate or Stopped Rate.
Gen Loading Frequency	The module detected that the generator output frequency had not risen above the Generator Loading Frequency setting after the Warming Up timer had expired.
Gen Loading Voltage	The module detected that the generator output voltage had not risen above the Generator Loading Voltage setting after the Warming Up timer had expired.
Gen Over Current IEEE C37.2 – 51 IDMT Overcurrent Relay	<p><b>▲ NOTE: For more details, see section 7.7 entitled Over Current Alarm in this document.</b></p> <p>The module detected that the generator output current had risen above the Generator Over Current Trip for the duration of the IDMT function.</p>
Gen Phase Seq Wrong IEEE C37.2 – 47 Phase Sequence Relay	The module detected that the phase rotation of the generator was different to the configured Generator Phase Rotation Alarm setting.
Gen Reverse Power IEEE C37.2 – 32 Directional Power Relay	The module detected that the generator output kW had fallen below the <i>Reverse Power Trip</i> for the configured delay timer.
Gen Short Circuit IEEE C37.2 – 51 IDMT Short Circuit Relay	<p><b>▲ NOTE: For more details, see section 7.8 entitled Short Circuit IDMT Alarm in this document.</b></p> <p>The module detected that the generator output current had risen above the <i>Short Circuit Trip</i> for the duration of the IDMT function.</p>

Continued over page...

Protections

Fault	Description
Inlet Temperature	The module detected that the engine's ECU measurement of inlet temperature had risen above the <i>Inlet Temperature Alarm Trip</i> level.
kW Overload IEEE C37.2 – 32 Directional Power Relay	The module detected that the generator output kW had risen above the Overload Protection Trip for the configured delay timer.
Loss of Mag-PU	The module detected that the magnetic pick up was not producing a pulse output after the required Crank Disconnect criteria had been met.
Low Load IEEE C37.2 – 37 Undercurrent or Underpower relay	The module detected that the load had fallen below the <i>Low Load Alarm Trip</i> level.
Mains Earth Fault IEEE C37.2 – 51G or 51N IDMT Earth Fault Relay	 <b>NOTE: For more details, see section 7.9 entitled Earth Fault IDMT Alarm in this document.</b>
	 <b>NOTE: Mains current protection is only available when the CT location is set for <i>Load</i>. For further details of module configuration, refer to DSE Publication: 057-243 DSE7310 MKII &amp; DSE7320 MKII Configuration Software Manual.</b>
	The module detected that the generator earth fault current had risen above the <i>Mains Earth Fault Trip Level</i> for the duration of the IDMT function.
Mains Over Current IEEE C37.2 – 51 IDMT Overcurrent Relay	 <b>NOTE: For more details, see section 7.7 entitled Over Current Alarm in this document.</b>
	 <b>NOTE: Mains current protection is only available when the CT location is set for <i>Load</i>. For further details of module configuration, refer to DSE Publication: 057-243 DSE7310 MKII &amp; DSE7320 MKII Configuration Software Manual.</b>
	The module detected that the mains output current had risen above the <i>Mains Over Current Trip</i> for the duration of the IDMT function.
Mains Phase Seq Wrong IEEE C37.2 – 47 Phase Sequence Relay	The module detected that the phase rotation of the mains was different to the configured <i>Mains Phase Rotation Alarm</i> setting.
Mains Short Circuit IEEE C37.2 – 51 IDMT Short Circuit Relay	 <b>NOTE: For more details, see section 7.8 entitled Short Circuit IDMT Alarm in this document.</b>
	 <b>NOTE: Mains current protection is only available when the CT location is set for <i>Load</i>. For further details of module configuration, refer to DSE Publication: 057-243 DSE7310 MKII &amp; DSE7320 MKII Configuration Software Manual.</b>
	The module detected that the mains output current had risen above the <i>Short Circuit Trip</i> for the duration of the IDMT function.

Continued over page...



Fault	Description
Maintenance Due	<p><b>▲ NOTE: Due to module configuration the alarm message that appears on the display may be different. For further details of module configuration, refer to DSE Publication: 057-243 DSE7310 MKII &amp; DSE7320 MKII Configuration Software Manual.</b></p> <p>The module detected that one of the configured maintenance alarms is due as its configured maintenance interval has expired.</p>
MSC ID Error	The module detected that another module on the <i>Dual Mutual Standby</i> communication link had the same <i>GenSet MSC ID</i> configured.
MSC Old Version Unit	The module detected that another module on the <i>Dual Mutual Standby</i> communication link had an incompatible <i>Dual Mutual Standby</i> version to its own.
Negative kvar IEEE C37.2 – 40 Field Under Excitation Relay	The module detected that the generator output kvar had fallen below the <i>Negative var Alarm Trip</i> for the configured delay timer.
Negative Phase Sequence IEEE C37.2 - 46 Phase-Balance Current Relay	The module detected that there was an imbalance of current across the generator phases greater than the <i>Negative Phase Sequence Trip Level</i> percentage setting.
Positive kvar IEEE C37.2 – 40 Field Over Excitation Relay	The module detected that the generator output kvar had risen above the <i>Positive var Alarm Trip</i> for the configured delay timer.
Priority Selection Error	The module detected that another module on the <i>Dual Mutual Standby</i> communication link had the same <i>GenSet Priority</i> configured.
SCR Inducement	The module received a fault condition from the engine ECU alerting about the SCR Inducement.
Water in Fuel	The module received a fault condition from the engine ECU alerting that water in the fuel had been detected.

## 7.5 SHUTDOWN ALARMS

**▲ NOTE:** The fault condition must be resolved before the alarm can be reset. If the fault condition remains, it is not possible to reset the alarm (the exception to this is the *Oil Pressure Low* alarm and similar *Active From Safety On* alarms, as the oil pressure is low with the engine at rest).

Shutdown Alarms are latching and immediately stop the Generator. On initiation of the shutdown condition the module de-activates the **Close Gen Output** outputs to remove the load from the generator. Once this has occurred, the module shuts the generator set down immediately to prevent further damage. To restart the generator the fault must be cleared, and the alarm reset.

Example:

1/2	Alarm
Oil Pressure Low	
Shutdown	

In the event of an alarm the LCD jumps to the alarms page and scrolls through all active alarms.

Shutdown Alarms are latching alarms and to remove the fault, press the **Stop/Reset Mode**  button on the module.

Fault	Description
2130 ID 1 to 4 Analogue Input E to H High	<div style="border: 1px solid black; padding: 5px; margin-bottom: 5px;"> <p><b>▲ NOTE:</b> Due to module configuration the alarm message that appears on the display may be different. For further details of module configuration, refer to DSE Publication: <i>057-243 DSE7310 MKII &amp; DSE7320 MKII Configuration Software Manual</i>.</p> </div> <p>The module detected that an analogue input value of a DSE2130 had risen above the <i>Flexible Sensor High Alarm Trip</i> level.</p>
2130 ID 1 to 4 Analogue Input E to H Low	<div style="border: 1px solid black; padding: 5px; margin-bottom: 5px;"> <p><b>▲ NOTE:</b> Due to module configuration the alarm message that appears on the display may be different. For further details of module configuration, refer to DSE Publication: <i>057-243 DSE7310 MKII &amp; DSE7320 MKII Configuration Software Manual</i>.</p> </div> <p>The module detected that an analogue input value of a DSE2130 had fallen below the <i>Flexible Sensor Low Alarm Trip</i> level.</p>
2130 ID1 to 4 Digital Input A to H	<div style="border: 1px solid black; padding: 5px; margin-bottom: 5px;"> <p><b>▲ NOTE:</b> Due to module configuration the alarm message that appears on the display may be different. For further details of module configuration, refer to DSE Publication: <i>057-243 DSE7310 MKII &amp; DSE7320 MKII Configuration Software Manual</i>.</p> </div> <p>The module detected that a digital input configured to create a fault condition on a DSE2130 expansion module became active and the appropriate LCD message displayed.</p>

Continued over page...

Fault	Description
DSE2131 ID 0 to 3 Analogue Input A to J High	<p><b>▲ NOTE:</b> Due to module configuration the alarm message that appears on the display may be different. For further details of module configuration, refer to DSE Publication: <i>057-243 DSE7310 MKII &amp; DSE7320 MKII Configuration Software Manual</i>.</p> <p>The module detected that an analogue input value of a DSE2131 had risen above the <i>Flexible Sensor High Alarm Trip</i> level.</p>
DSE2131 ID 0 to 3 Analogue Input A to J Low	<p><b>▲ NOTE:</b> Due to module configuration the alarm message that appears on the display may be different. For further details of module configuration, refer to DSE Publication: <i>057-243 DSE7310 MKII &amp; DSE7320 MKII Configuration Software Manual</i>.</p> <p>The module detected that an analogue input value of a DSE2131 had fallen below the <i>Flexible Sensor Low Alarm Trip</i> level.</p>
DSE2131 ID 0 to 3 Digital Input A to J	<p><b>▲ NOTE:</b> Due to module configuration the alarm message that appears on the display may be different. For further details of module configuration, refer to DSE Publication: <i>057-243 DSE7310 MKII &amp; DSE7320 MKII Configuration Software Manual</i>.</p> <p>The module detected that a digital input configured to create a fault condition on a DSE2131 expansion module became active and the appropriate LCD message displayed.</p>
DSE2133 ID 0 to 3 Analogue Input A to H High	<p><b>▲ NOTE:</b> Due to module configuration the alarm message that appears on the display may be different. For further details of module configuration, refer to DSE Publication: <i>057-243 DSE7310 MKII &amp; DSE7320 MKII Configuration Software Manual</i>.</p> <p>The module detected that an analogue input value of a DSE2133 had risen above the <i>Temperature Sensor High Alarm Trip</i> level.</p>
DSE2133 ID 0 to 3 Analogue Input A to H Low	<p><b>▲ NOTE:</b> Due to module configuration the alarm message that appears on the display may be different. For further details of module configuration, refer to DSE Publication: <i>057-243 DSE7310 MKII &amp; DSE7320 MKII Configuration Software Manual</i>.</p> <p>The module detected that an analogue input value of a DSE2133 had fallen below the <i>Temperature Sensor Low Alarm Trip</i> level.</p>
Charger ID 0 to 3 Common Shutdown	<p><b>▲ NOTE:</b> Due to module configuration the alarm message that appears on the display may be different. For further details of module configuration, refer to DSE Publication: <i>057-243 DSE7310 MKII &amp; DSE7320 MKII Configuration Software Manual</i>.</p> <p>The module detected that a battery charger connected by DSENet® had issued a <i>Common Shutdown Alarm</i>.</p>

Continued over page...

Fault	Description
Analogue Input A to F (Digital)	<p><b>▲ NOTE: Due to module configuration the alarm message that appears on the display may be different. For further details of module configuration, refer to DSE Publication: 057-243 DSE7310 MKII &amp; DSE7320 MKII Configuration Software Manual.</b></p> <p>The module detected that an analogue input configured as a digital input to create a fault condition became active and the appropriate LCD message is displayed.</p>
Auto Sense Fail	The module detected that the output voltage of the generator had risen above the <i>Over Voltage During Auto Sensing Trip</i> level during starting whilst attempting to detect which alternative configuration to use.
AVR Data Fail	The module is configured to communicate to the generator's AVR by CAN but has not detected data being sent from the generator's AVR.
AVR Fault	The module received a red fault condition from the alternators AVR.
Battery Temp	The module detected that a battery charger connected by DSENet® had issued a <i>Battery Temperature</i> alarm
Calibration Fault	The module detected that its internal calibration has failed. The unit must be sent back to DSE to be investigated and repaired. Contact DSE Technical Support for more details.
Charge Alt Failure IEEE C37.2 – 27DC Undervoltage Relay	The module detected that the output voltage of the charge alternator had risen above the <i>Charge Alternator Shutdown Trip</i> level for the configured delay timer.
Charger Failure	The module detected that a battery charger connected by DSENet® had a <i>Failure</i> alarm.
Charger Fan Locked	The module detected that a battery charger connected by DSENet® had a <i>Failure</i> alarm.
Charger High Temperature	The module detected that a battery charger connected by DSENet® had a <i>High Temperature</i> alarm.
Charger Input Fuse Fail	The module detected that a battery charger connected by DSENet® had an <i>Input Fuse Fail</i> alarm.
Charger Mains High Current	The module detected that a battery charger connected by DSENet® had a <i>Mains High Current</i> alarm.
Charger Mains High Voltage	The module detected that a battery charger connected by DSENet® had a <i>Mains High Voltage</i> alarm.
Charger Mains Low Voltage	The module detected that a battery charger connected by DSENet® had a <i>Mains Low Voltage</i> alarm.
Charger Reverse Polarity	The module detected that a battery charger connected by DSENet® had a <i>Reverse Polarity</i> alarm.
Charger Short Circuit	The module detected that a battery charger connected by DSENet® had a <i>Short Circuit</i> alarm.
Charger Short Circuit / Reverse Polarity	The module detected that a battery charger connected by DSENet® had a combined <i>Short Circuit</i> and <i>Reverse Polarity</i> alarm.
Coolant Sender O/C	The module detected that circuit to the engine coolant temperature sensor had become open circuit.
Coolant Temp High IEEE C37.2 – 26 Apparatus Thermal Device	The module detected that the engine coolant temperature had risen above the <i>High Coolant Temperature Shutdown Trip</i> level after the <i>Safety On Delay</i> timer had expired.
Coolant Temp High Switch IEEE C37.2 – 26 Apparatus Thermal Device	The module detected that the high engine coolant temperature switch had activated after the <i>Safety On Delay</i> timer had expired.



Continued over page...

Fault	Description
DEF Level	The module received a fault condition from the engine ECU alerting about the DEF level or the module detected that the <i>DEF Level</i> had fallen below the <i>DEF Level Low Alarm Trip</i> level for the configured delay timer.
Digital Input A to H	<div style="border: 1px solid black; padding: 5px; margin-bottom: 5px;"> <p><b>▲ NOTE: Due to module configuration the alarm message that appears on the display may be different. For further details of module configuration, refer to DSE Publication: 057-243 DSE7310 MKII &amp; DSE7320 MKII Configuration Software Manual.</b></p> </div> <p>The module detected that a digital input configured to create a fault condition became active and the appropriate LCD message is displayed.</p>
DPTC Filter	The module received a fault condition from the engine ECU alerting that the DPF/DPTC had activated.
Earth Fault IEEE C37.2 – 51G or 51N Generator IDMT Earth Fault Relay	<div style="border: 1px solid black; padding: 5px; margin-bottom: 5px;"> <p><b>▲ NOTE: For more details, see section 7.9 entitled Earth Fault IDMT Alarm in this document.</b></p> </div> <p>The module detected that the generator earth fault current had risen above the <i>Generator Earth Fault Trip Level</i> for the duration of the IDMT function.</p>
ECU Amber	The module received an amber fault condition from the engine ECU.
ECU Data Fail	The module is configured for CAN operation but has not detected data being sent from the engine's ECU.
ECU Malfunc.	The module received a malfunction fault condition from the engine ECU.
ECU Protect	The module received a protect fault condition from the engine ECU.
ECU Red	The module received a red fault condition from the engine ECU.
Emergency Stop IEEE C37.2 - 5 Stopping Device	The module detected that emergency stop button had been pressed removing a positive voltage supply from the emergency stop input terminal. This input is failsafe (normally closed to emergency stop) and immediately stops the generator when the signal is removed.
Engine Over Speed IEEE C37.2 - 12 Overspeed Device	The module detected that the engine speed had risen above the <i>Over Speed Alarm Trip</i> level for the configured delay timer.
Engine Over Speed Overshoot IEEE C37.2 - 12 Overspeed Device	The module detected that the engine speed had risen above the <i>Over Speed Overshoot Trip</i> during the configured <i>Overshoot Delay</i> timer whilst starting.
Engine Under Speed IEEE C37.2 - 14 Underspeed Device	The module detected that the engine speed had fallen below the <i>Under Speed Alarm Trip</i> level for the configured delay timer after the <i>Safety On Delay</i> timer had expired.
Exp. Unit Failure	The module detected that communications to one of the DSENet <sup>®</sup> expansion modules had been lost.
Fail to Synchronise	The module failed to synchronise the generator to the mains before the Fail to Sync Delay timer had expired.







Continued over page...

Fault	Description
Failed to Start IEEE C37.2 - 48 Incomplete Sequence Relay	The module detected that the generator had failed to start as it did not meet the required Crank Disconnect criteria during the configured number of Crank Attempts.
Failed to Stop IEEE C37.2 - 48 Incomplete Sequence Relay	<p><b>▲ NOTE: <i>Fail to Stop</i> could indicate a faulty oil pressure sensor. If engine is at rest, check the oil pressure sensor wiring and configuration.</b></p> <p>The module detects a condition that indicates the generator is running when the DSE module has instructed it to stop.</p>
Flexible Sensor A to F Fault	<p><b>▲ NOTE: Due to module configuration the alarm message that appears on the display may be different. For further details of module configuration, refer to DSE Publication: 057-243 DSE7310 MKII &amp; DSE7320 MKII Configuration Software Manual.</b></p> <p>The module detected that circuit to the flexible sensor had become open circuit.</p>
Flexible Sensor A to F High	<p><b>▲ NOTE: Due to module configuration the alarm message that appears on the display may be different. For further details of module configuration, refer to DSE Publication: 057-243 DSE7310 MKII &amp; DSE7320 MKII Configuration Software Manual.</b></p> <p>The module detected that an analogue input value had risen above the <i>Flexible Sensor High Alarm Trip</i> level.</p>
Flexible Sensor A to F Low	<p><b>▲ NOTE: Due to module configuration the alarm message that appears on the display may be different. For further details of module configuration, refer to DSE Publication: 057-243 DSE7310 MKII &amp; DSE7320 MKII Configuration Software Manual.</b></p> <p>The module detected that an analogue input value had fallen below the <i>Flexible Sensor Low Alarm Trip</i> level.</p>
Fuel Level High IEEE C37.2 - 71 Liquid Level Switch	The module detected that the engine fuel level rose above the <i>High Fuel Level Trip</i> level.
Fuel Level Low IEEE C37.2 - 71 Liquid Level Switch	The module detected that the engine fuel level had fallen below the <i>Low Fuel Level Trip</i> level.
Fuel Level Low Switch IEEE C37.2 - 71 Liquid Level Switch	The module detected that the engine low fuel level switch had activated.
Fuel Sensor Fault	The module detected that circuit to the engine fuel level sensor had become open circuit.
Fuel Tank Bund Level High IEEE C37.2 - 71 Liquid Level Switch	The module detected that the fuel tank bund level switch had activated.
Fuel Usage IEEE C37.2 - 80 Flow Switch	The module detected that the fuel consumption was more than the configured Running Rate or Stopped Rate.

Continued over page...

Fault	Description
Gen Loading Frequency	The module detected that the generator output frequency had not risen above the Generator Loading Frequency setting after the Warming Up timer had expired.
Gen Loading Voltage	The module detected that the generator output voltage had not risen above the Generator Loading Voltage setting after the Warming Up timer had expired.
Gen Over Current IEEE C37.2 – 51 IDMT Overcurrent Relay	<div style="border: 1px solid black; padding: 5px; margin-bottom: 5px;">  <b>NOTE: For more details, see section 7.7 entitled Over Current Alarm in this document.</b> </div> <p>The module detected that the generator output current had risen above the <i>Generator Over Current Trip</i> for the duration of the IDMT function.</p>
Gen Over Frequency IEEE C37.2 – 81 Frequency Relay	The module detected that the generator output frequency had risen above the <i>Over Frequency Alarm Trip</i> level for the configured delay timer.
Gen Over Frequency Overshoot IEEE C37.2 – 81 Frequency Relay	The module detected that the generator output frequency had risen above the <i>Over Frequency Overshoot Trip</i> during the configured <i>Overshoot Delay</i> timer whilst starting.
Gen Over Voltage IEEE C37.2 – 59 AC Overvoltage Relay	The module detected that the generator output voltage had risen above the <i>Over Voltage Alarm Trip</i> level for the configured delay timer.
Gen Phase Seq Wrong IEEE C37.2 – 47 Phase Sequence Relay	The module detected that the phase rotation of the generator was different to the configured <i>Generator Phase Rotation Alarm</i> setting.
Gen Reverse Power IEEE C37.2 – 32 Directional Power Relay	The module detected that the generator output kW had fallen below the <i>Reverse Power Trip</i> for the configured delay timer.
Gen Short Circuit IEEE C37.2 – 51 IDMT Short Circuit Relay	<div style="border: 1px solid black; padding: 5px; margin-bottom: 5px;">  <b>NOTE: For more details, see section 7.8 entitled Short Circuit IDMT Alarm in this document.</b> </div> <p>The module detected that the generator output current had risen above the <i>Short Circuit Trip</i> for the duration of the IDMT function.</p>
Gen Under Frequency IEEE C37.2 – 81 Frequency Relay	The module detected that the generator output frequency had fallen below the <i>Under Frequency Alarm Trip</i> level for the configured delay timer after the <i>Safety On Delay</i> timer had expired.
Gen Under Voltage IEEE C37.2 – 27 AC Undervoltage Relay	The module detected that the generator output voltage had fallen below the <i>Under Voltage Alarm Trip</i> level for the configured delay timer after the <i>Safety On Delay</i> timer had expired.
Inlet Temperature	The module detected that the engine's ECU measurement of inlet temperature had risen above the <i>Inlet Temperature Alarm Trip</i> level.
kW Overload IEEE C37.2 – 32 Directional Power Relay	The module detected that the generator output kW had risen above the Overload Protection Trip for the configured delay timer.
Loss of Mag-PU	The module detected that the magnetic pick up was not producing a pulse output after the required Crank Disconnect criteria had been met.
Low Load IEEE C37.2 – 37 Undercurrent of Underpower relay	The module detected that the load had fallen below the <i>Low Load Alarm Trip</i> level.

Continued over page...

Fault	Description
Mag-PU Fault	The module detected that circuit to the magnetic pick-up sensor had become open circuit.
Mains Earth Fault IEEE C37.2 – 51G or 51N IDMT Earth Fault Relay	 <b>NOTE: For more details, see section 7.9 entitled Earth Fault IDMT Alarm in this document.</b>
	 <b>NOTE: Mains current protection is only available when the CT location is set for Load. For further details of module configuration, refer to DSE Publication: 057-243 DSE7310 MKII &amp; DSE7320 MKII Configuration Software Manual.</b>
	The module detected that the generator earth fault current had risen above the <i>Mains Earth Fault Trip Level</i> for the duration of the IDMT function.
Mains Failed to Close IEEE C37.2 – 52b AC Circuit Breaker Position (Contact Open when Breaker Closed)	The module detected that the mains load switch had failed to close as the Mains Closed Auxiliary input did not activate within the Mains Fail to Close Delay time after the Close Mains Output activated.
Mains Over Current IEEE C37.2 – 51 IDMT Overcurrent Relay	 <b>NOTE: For more details, see section 7.7 entitled Over Current Alarm in this document.</b>
	 <b>NOTE: Mains current protection is only available when the CT location is set for Load. For further details of module configuration, refer to DSE Publication: 057-243 DSE7310 MKII &amp; DSE7320 MKII Configuration Software Manual.</b>
	The module detected that the mains output current had risen above the <i>Mains Over Current Trip</i> for the duration of the IDMT function.
Mains Phase Seq Wrong IEEE C37.2 – 47 Phase Sequence Relay	The module detected that the phase rotation of the mains was different to the configured <i>Mains Phase Rotation Alarm</i> setting.
Mains Short Circuit IEEE C37.2 – 51 IDMT Short Circuit Relay	 <b>NOTE: For more details, see section 7.8 entitled Short Circuit IDMT Alarm in this document.</b>
	 <b>NOTE: Mains current protection is only available when the CT location is set for Load. For further details of module configuration, refer to DSE Publication: 057-243 DSE7310 MKII &amp; DSE7320 MKII Configuration Software Manual.</b>
	The module detected that the mains output current had risen above the <i>Short Circuit Trip</i> for the duration of the IDMT function.
Maintenance Due	 <b>NOTE: Due to module configuration the alarm message that appears on the display may be different. For further details of module configuration, refer to DSE Publication: 057-243 DSE7310 MKII &amp; DSE7320 MKII Configuration Software Manual.</b>
	The module detected that one of the configured maintenance alarms is due as its configured maintenance interval has expired.

Continued over page...



Protections

Fault	Description
Negative kvar IEEE C37.2 – 40 Field Under Excitation Relay	The module detected that the generator output kvar had fallen below the <i>Negative var Alarm Trip</i> for the configured delay timer.
Negative Phase Sequence IEEE C37.2 - 46 Phase-Balance Current Relay	The module detected that there was an imbalance of current across the generator phases greater than the <i>Negative Phase Sequence Trip Level</i> percentage setting.
Oil Press Sender Fault	The module detected that circuit to the engine oil pressure sensor had become open circuit.
Oil Pressure Low IEEE C37.2 - 63 Pressure Switch	The module detected that the engine oil pressure had fallen below the <i>Low Oil Pressure Shutdown Trip</i> level after the <i>Safety On Delay</i> timer had expired.
Oil Pressure Low Switch IEEE C37.2 - 63 Pressure Switch	The module detected that the low oil pressure switch had activated after the <i>Safety On Delay</i> timer had expired.
Over Frequency Runaway IEEE C37.2 – 81 Frequency Relay	The module detected that the generator output frequency had risen above the <i>Run Away Trip</i> level.
Over Speed Runaway IEEE C37.2 - 12 Overspeed Device	The module detected that the engine speed had risen above the <i>Run Away Trip</i> level.
Positive kvar IEEE C37.2 – 40 Field Over Excitation Relay	The module detected that the generator output kvar had risen above the <i>Positive var Alarm Trip</i> for the configured delay timer.
Priority Selection Error	The module detected that another module on the <i>Dual Mutual Standby</i> communication link
SCR Inducement	The module received a fault condition from the engine ECU alerting about the SCR Inducement.
Water in Fuel	The module received a fault condition from the engine ECU alerting that water in the fuel had been detected.

## 7.6 MAINTENANCE ALARMS

Depending upon module configuration one or more levels of engine maintenance alarm may occur based upon a configurable schedule.

### Example 1:

Screen capture from DSE Configuration Suite Software showing the configuration of the Maintenance Alarm for 1, 2 and 3.

When activated, the maintenance alarm can be either a **warning** (set continues to run) or **shutdown** (running the set is not possible).

Resetting the maintenance alarm is normally actioned by the site service engineer after performing the required maintenance.

The method of reset is either by:

Activating an input that has been configured to Maintenance Reset Alarm 1, 2 or 3.

Pressing the maintenance reset button in the DSE Configuration Suite, Maintenance section.

Pressing and holding the **Stop/Reset**

**Mode**  button for 10 seconds on the desired Maintenance Alarm status page. This may be protected by a PIN number.

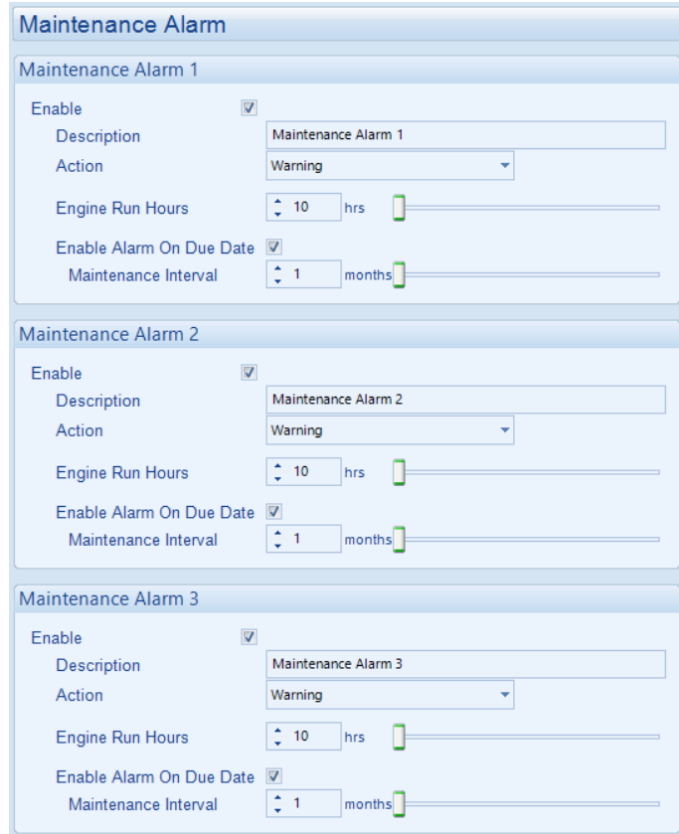

**Maintenance Alarm**

**Maintenance Alarm 1**

Enable

Description Maintenance Alarm 1

Action Warning

Engine Run Hours 10 hrs

Enable Alarm On Due Date

Maintenance Interval 1 months

**Maintenance Alarm 2**

Enable

Description Maintenance Alarm 2

Action Warning

Engine Run Hours 10 hrs

Enable Alarm On Due Date

Maintenance Interval 1 months

**Maintenance Alarm 3**

Enable

Description Maintenance Alarm 3

Action Warning

Engine Run Hours 10 hrs

Enable Alarm On Due Date

Maintenance Interval 1 months

### Example 2:

Screen capture from DSE Configuration Suite Software showing the configuration of a digital input for Reset Maintenance Alarm.

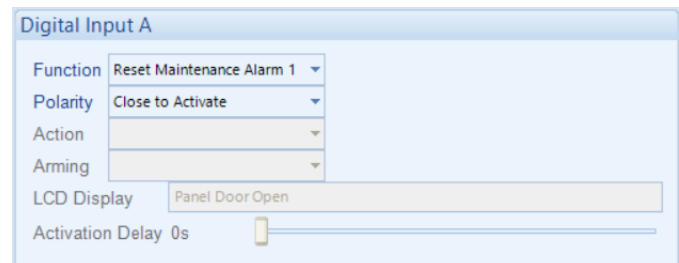

**Digital Input A**

Function Reset Maintenance Alarm 1

Polarity Close to Activate

Action

Arming

LCD Display Panel Door Open

Activation Delay 0s

## Protections

### Example 3:

Screen capture from DSE Configuration Suite Software showing the Maintenance Alarm Reset 'button' in the DSE Configuration Suite SCADA | MAINTENANCE section.

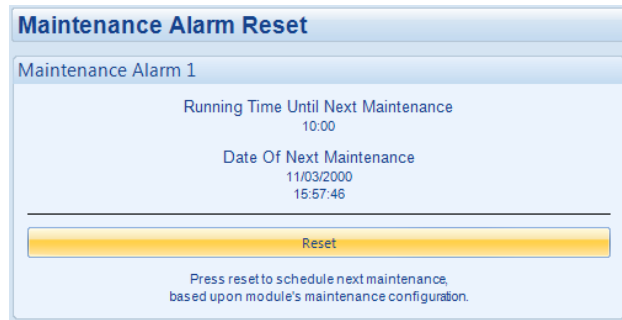

### Example 4:

Screen capture from DSE Configuration Suite Software showing the configuration holding stop button to reset the maintenance alarm.

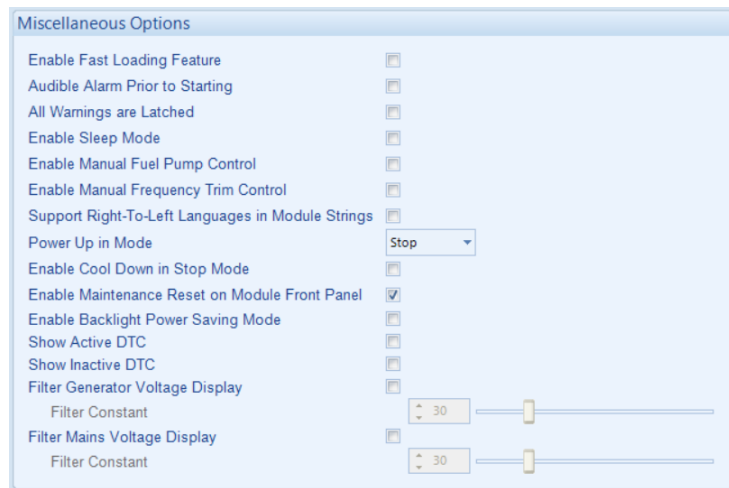

## 7.7 OVER CURRENT ALARM

The *Over Current Alarm* combines a simple warning trip level with a fully functioning IDMT curve for thermal protection.

### 7.7.1 IMMEDIATE WARNING

If the *Immediate Warning* is enabled, the controller generates a *warning alarm* as soon as the *Trip* level is reached. The alarm automatically resets once the generator loading current falls below the *Trip* level (unless *All Warnings are latched* is enabled). For further advice, consult the generator supplier.

### 7.7.2 INVERSE DEFINITE MINIMUM TIME (IDMT) ALARM

If the *Over Current IDMT Alarm* is enabled, the controller begins following the IDMT 'curve' when the current on any phase passes the *Trip* setting.

If the *Trip* is surpassed for an excess amount of time, the *IDMT Alarm* triggers (*Shutdown* or *Electrical Trip* as selected in *Action*).

The larger the over circuit fault, the faster the trip. The speed of the trip is dependent upon the fixed formula:

$$T = \frac{t}{\left(\frac{I_A}{I_T} - 1\right)^2}$$

**Where:**

$T$  is the tripping time in seconds

$I_A$  is the actual measured current of the most highly loaded line (L1, L2 or L3)

$I_T$  is the delayed trip point setting in current

$t$  is the time multiplier setting and represents the tripping time in seconds at twice full load

(when  $I_A/I_T = 2$ ).

The settings shown in the example below are a screen capture of the DSE factory settings, taken from the DSE Configuration Suite PC Software for a brushless alternator.

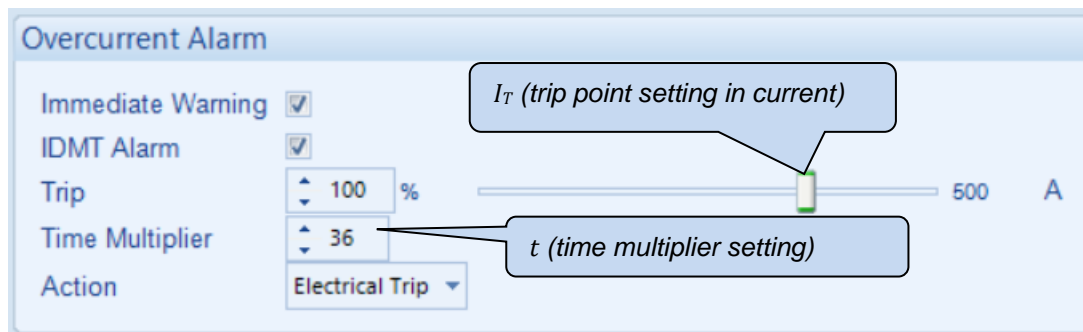

These settings provide for normal running of the generator up to 100% full load. If full load is surpassed, the *Immediate Warning* alarm is triggered, and the set continues to run.

The effect of an overload on the generator is that the alternator windings begin to overheat; the aim of the *IDMT Alarm* is to prevent the windings being overload (heated) too much. The amount of time that the alternator can be safely overloaded is governed by how high the overload condition is.

The default settings as shown above allow for an overload of the alternator to the limits of the *Typical Brushless Alternator* whereby 110% overload is permitted for 1 hour or 200% overload is permitted for 36 seconds.

If the alternator load reduces, the controller then follows a cooling curve. This means that a second overload condition may trip soon after the first as the controller knows if the windings have not cooled sufficiently.

For further details on the *Thermal Damage Curve* of your alternator, refer to the alternator manufacturer and generator supplier.

7.7.2.1 CREATING A SPREADSHEET FOR THE OVER CURRENT IDMT CURVE

The formula used:

$$T = \frac{t}{\left(\frac{I_A}{I_T} - 1\right)^2}$$

Where:

$T$  is the tripping time in seconds

$I_A$  is the actual measured current of the most highly loaded line (L1, L2 or L3)

$I_T$  is the delayed trip point setting in current

$t$  is the time multiplier setting and represents the tripping time in seconds at twice full load (when  $I_A/I_T = 2$ ).

The equation can be simplified for addition into a spreadsheet. This is useful for ‘trying out’ different values of  $t$  (*time multiplier setting*) and viewing the results, without testing this on the generator.

	A	B	C	D	E	F
1		1.01	1.02	1.03	1.05	1.06
2	36	360000	90000	40000	14400	10000

$I_A/I_T$  (multiple of the Trip setting from 1.01 to 3.0 in steps of 0.1)

$t$  (time multiplier setting)

$T$  (tripping time in seconds)

The formula for the *Tripping Time* cells is:

`=A2/POWER((B$1-1),2)`

# Over Current IDMT Alarm Curves

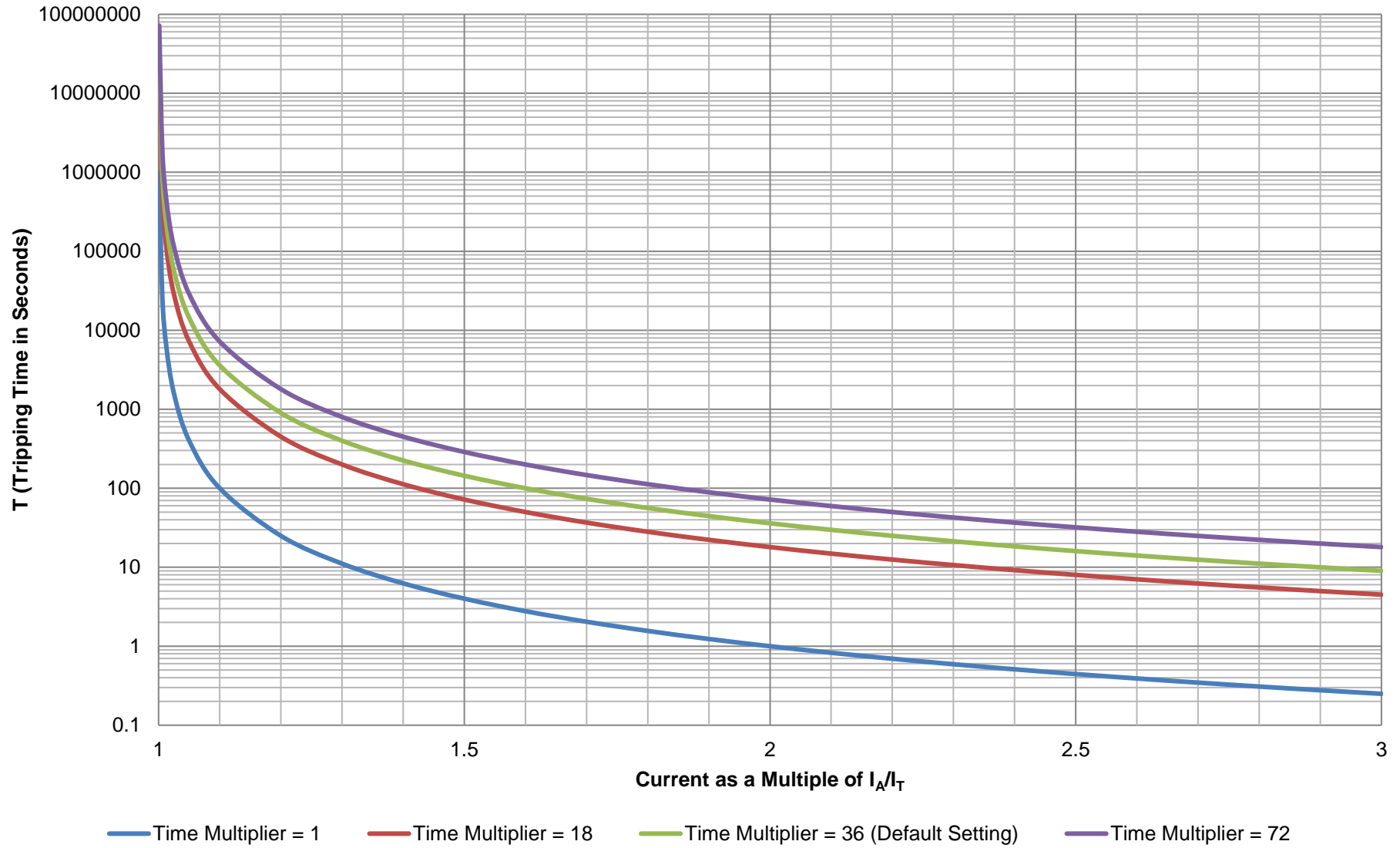

## 7.8 SHORT CIRCUIT IDMT ALARM

If the *Short Circuit Alarm* is enabled, the controller begins following the IDMT 'curve' when the current on any phase passes the *Trip* setting.

If the *Trip* is surpassed for an excess amount of time, the *IDMT Alarm* triggers (*Shutdown* or *Electrical trip* as selected in *Action*).

The larger the short circuit fault, the faster the trip. The speed of the trip is dependent upon the fixed formula:

$$T = \frac{t \times 0.14}{\left(\left(\frac{I_A}{I_T}\right)^{0.02} - 1\right)}$$

**Where:**

$T$  is the tripping time in seconds (accurate to +/- 5% or +/- 50 ms (whichever is the greater))

$I_A$  is the actual measured current

$I_T$  is the trip point setting in current

$t$  is the time multiplier setting

The settings shown in the example below are a screen capture of the DSE factory settings, taken from the DSE Configuration Suite software.

**NOTE:** Due to large inrush currents from certain loads, such as motors or transformers, the default settings for the *Short Circuit* alarm may need adjusting to compensate.

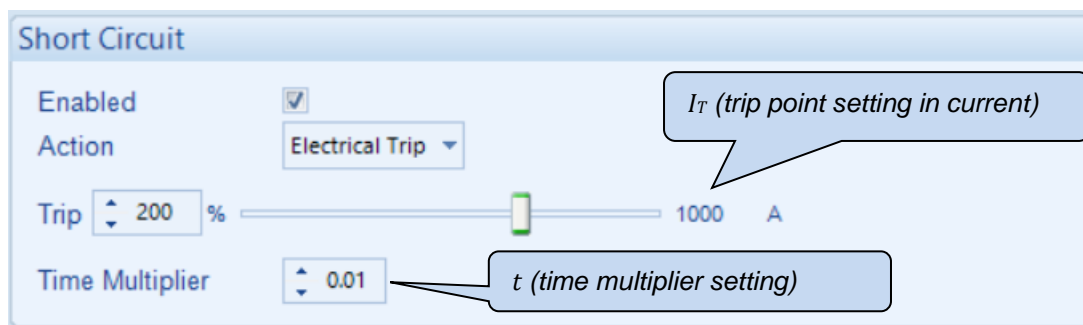

The effect of a short circuit on the generator is that the alternator stator and rotor begin to overheat; the aim of the *IDMT alarm* is to prevent the stator and rotor being overload (heated) too much. The amount of time that the alternator can be safely overloaded is governed by how high the short circuit condition is.

For further details on the *Thermal & Magnetic Damage Curve* of your alternator, refer to the alternator manufacturer and generator supplier.



### 7.8.1 CREATING A SPREADSHEET FOR THE SHORT CIRCUIT IDMT CURVE

The formula used:

$$T = \frac{t \times 0.14}{\left(\left(\frac{I_A}{I_T}\right)^{0.02} - 1\right)}$$

**Where:**

$T$  is the tripping time in seconds (accurate to +/- 5% or +/- 50 ms (whichever is the greater))

$I_A$  is the actual measured current

$I_T$  is the trip point setting in current

$t$  is the time multiplier setting

The equation can be simplified for addition into a spreadsheet. This is useful for 'trying out' different values of  $t$  (*time multiplier setting*) and viewing the results, without testing this on the generator.

	A	B	C	D	E	F
1		1.01	1.02	1.03	1.05	1.06
2	0.01	7.034242	25	11.11111	4	2.777778

$I_A/I_T$  (multiple of the Trip setting from 1.01 to 3.0 in steps of 0.1)

$t$  (time multiplier setting)

$T$  (tripping time in seconds)

The formula for the *Tripping Time* cells is:

```
=($A2*0.14)/(POWER((B$1),0.02)-1)
```

# Short Circuit IDMT Alarm Curves

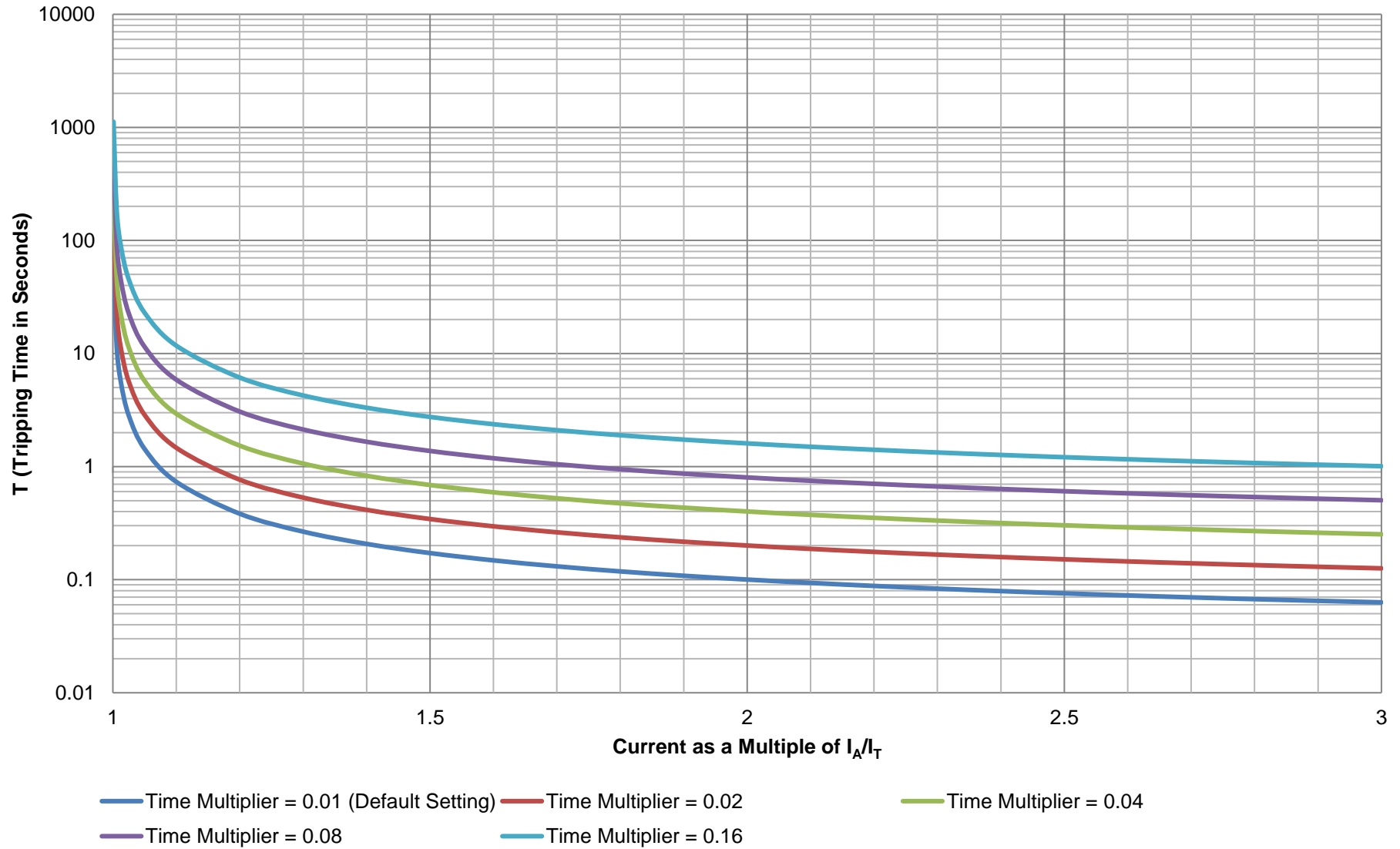

## 7.9 EARTH FAULT IDMT ALARM

When the module is suitably connected using the 'Earth Fault CT'. The module measures Earth Fault and optionally configured to generate an alarm condition (shutdown or electrical trip) when a specified level is surpassed.

If the *Earth Fault Alarm* is enabled, the controller begins following the IDMT 'curve' when the earth fault current passes the *Trip* setting.

If the *Trip* is surpassed for an excess amount of time, the *IDMT Alarm* triggers (*Shutdown* or *Electrical Trip* as selected in *Action*).

The larger the earth fault, the faster the trip.

The settings shown in the example below are a screen capture of the DSE factory settings, taken from the DSE Configuration Suite software.

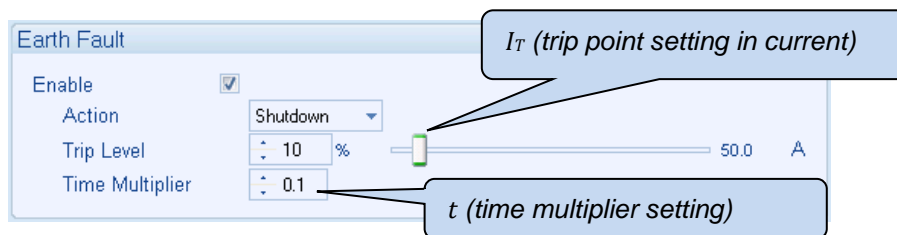

# Earth Fault Alarm IDMT Curves

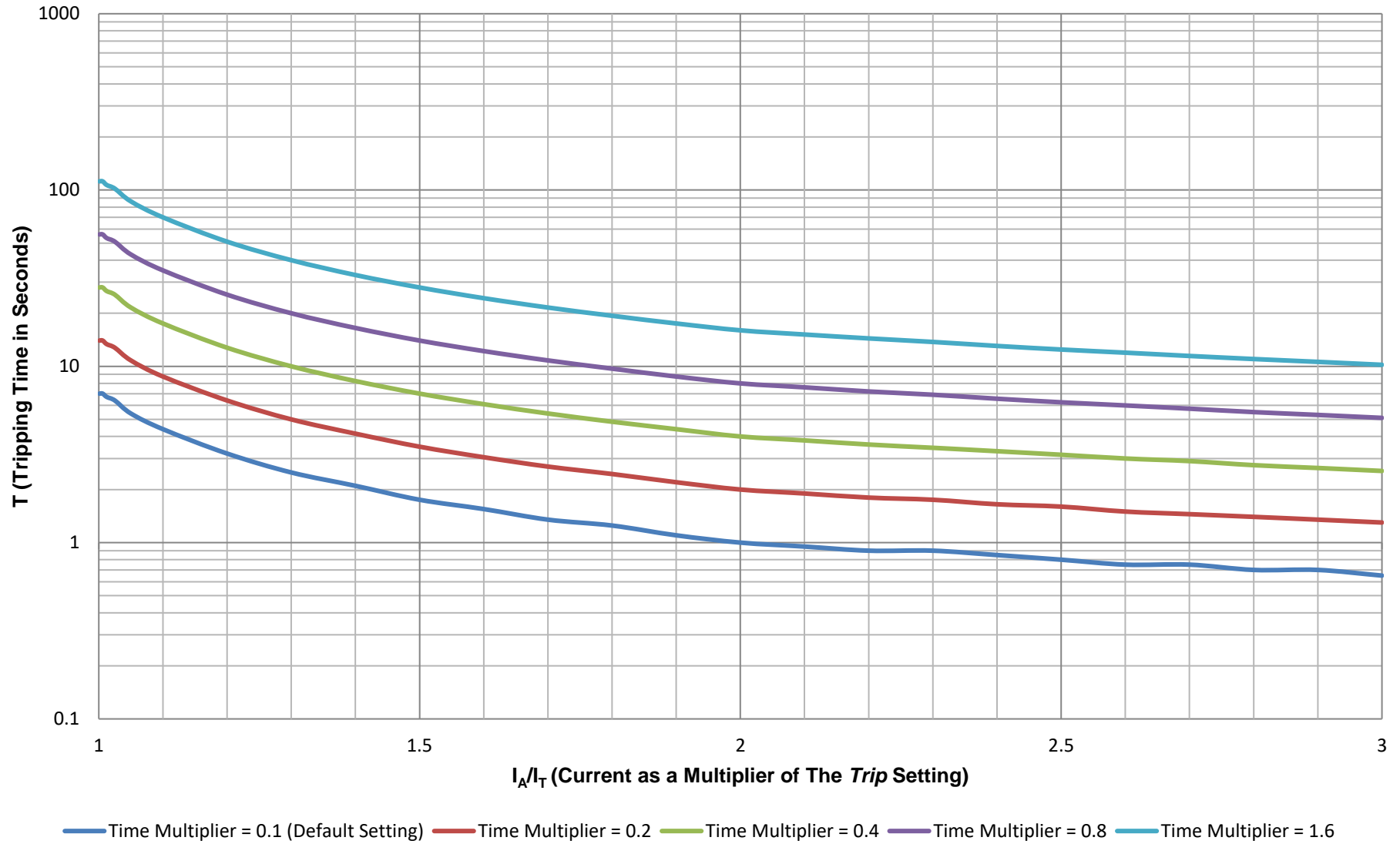

## 7.10 DEFAULT CURRENT PROTECTION TRIPPING CHARACTERISTICS

The graph on the following page shows the default settings for the IDMT tripping curves for the *Over Current*, *Short Circuit* and *Earth Fault* protections.

The default setting for the *Over Current* alarm allows for an overload of an alternator to the limits of the *Typical Brushless Alternator* whereby 110% overload is permitted for 1 hour or 200% overload is permitted for 36 seconds. In an over current situation, the alternator begins to overheat. The aim of the *Over Current IDMT Alarm* is to prevent the windings being overloaded (heated) too much. The amount of time that the alternator can be safely overloaded is governed by how high the overload condition is.

The default setting for the *Short Circuit* alarm allows for an alternator to supply a high current caused by a genuine short circuit or an inrush current of a motor/transformer. Whereby 300% overload is permitted for 0.17 seconds or 600% overload is permitted for 0.06 seconds. In a short circuit situation, the alternator begins to overheat to the point the insulation breaks down, potentially causing a fire. The aim of the *Short Circuit IDMT Alarm* is to prevent the insulation from melting due to excessive heat. The amount of time that the alternator can be safely in a short circuit condition is governed by the alternator's construction.

The default setting for the *Earth Fault* alarm allows for an alternator to supply a fault current caused by a high impedance short to earth or motor drives. Whereby 15% fault current is permitted for 1.75 second or 20% fault current is permitted for 1 second.

## DSE Default Configuration of Over Current, Short Circuit & Earth Fault Alarm IDMT Curves

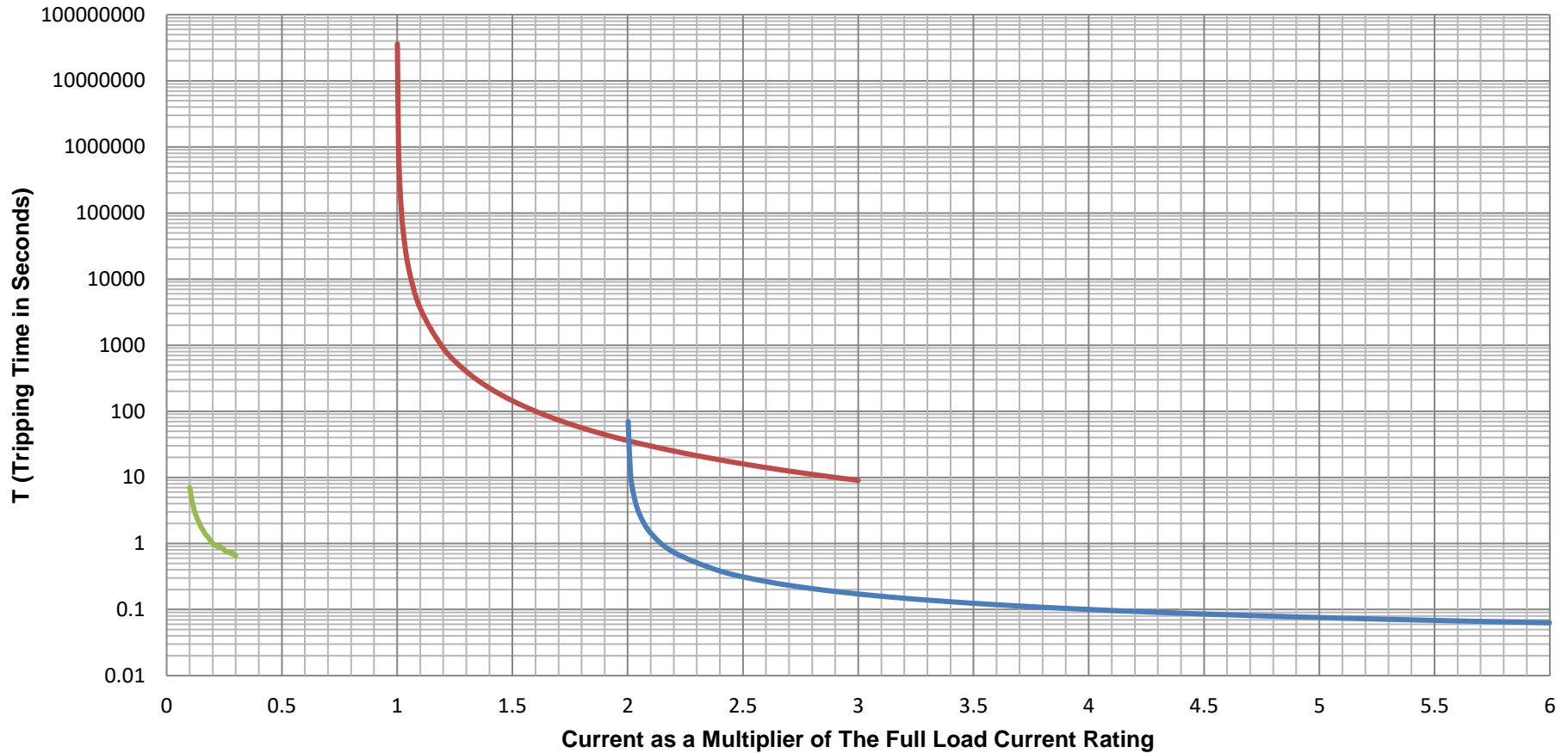

- Over Circuit IDMT Trip Curve with Time Multiplier = 36, Trip Point = 100% (Default Settings)
- Short Circuit IDMT Trip Curve with Time Multiplier = 0.01, Trip Point = 200% (Default Settings)
- Earth Fault IDMT Trip Curve with Time Multiplier = 0.1, Trip Point = 10% (Default Settings)

## 8 FRONT PANEL CONFIGURATION

**NOTE:** Depending upon module configuration, some values in the *Mains & Running Configuration Editors* may not be available. For more information refer to DSE publication 057-243 *DSE7310 MKII & DSE7320 MKII Configuraiton Suite PC Software Manual*

This configuration mode allows the operator to partially configure the module through its display without the use of the DSE Configuration Suite PC Software.

Use the module's facia buttons to traverse the menu and make value changes to the parameters:

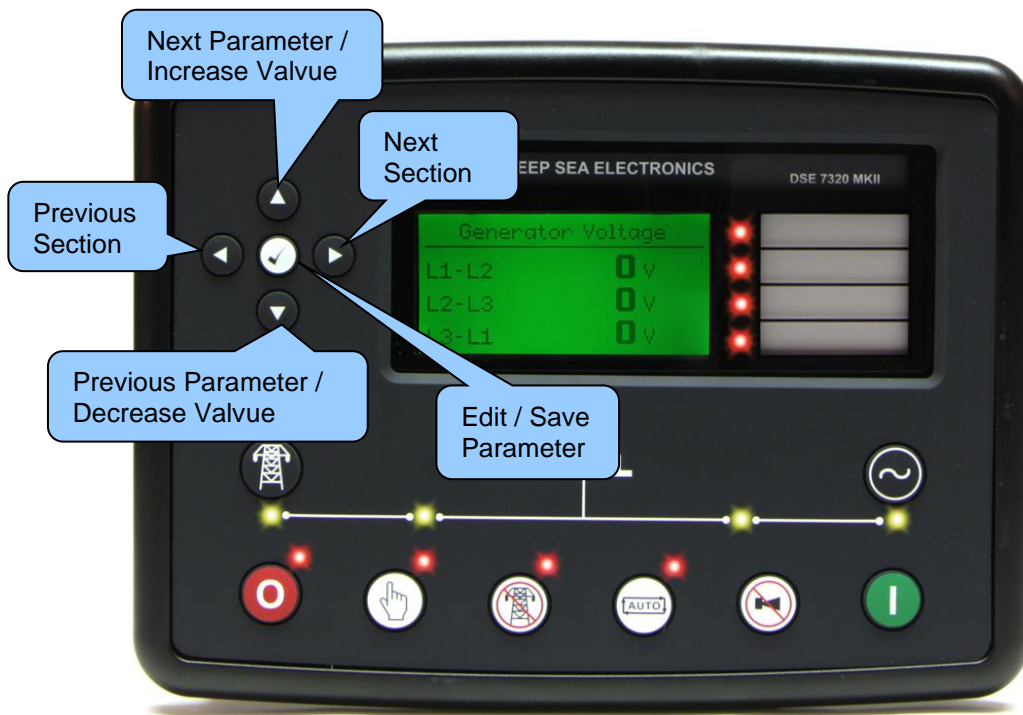

## 8.1 MAIN CONFIGURATION EDITOR

### 8.1.1 ACCESSING THE MAIN CONFIGURATION EDITOR

 **NOTE:** More comprehensive module configuration is possible via PC configuration software. For further details of module configuration, refer to DSE Publication: 057- 224 DSE7310 MKII & DSE7310 MKII Configuration Software Manual.

- Ensure the engine is at rest and the module by pressing the **Stop/Reset Mode**  button.

- Press the **Stop/Reset Mode**  and **Tick**  buttons together to enter the main configuration editor.

### 8.1.2 ENTERING PIN

 **NOTE:** The PIN is not set by DSE when the module leaves the factory. If the module has a PIN code set, the generator supplier has entered this. Contact the generator supplier if the code is required. If the code has been 'lost' or 'forgotten', the module must be returned to the DSE factory to have the PIN removed. A charge is made for this procedure. This procedure cannot be performed away from the DSE factory.

 **NOTE:** The PIN is automatically reset after exiting the editor (manually or automatically) to ensure security.

- If a module security PIN has been set, the PIN request is then shown.

- The first '#' changes to '0'. Press the **Up** or **Down**  buttons to adjust it to the correct value.

- Press the **Right**  button when the first digit is correctly entered. The digit previously entered now shows as '#' for security.



- Repeat this process for the other digits of the PIN number. Press the **Left**  button to move back to adjust one of the previous digits.

- When the **Tick**  button is pressed after editing the final PIN digit, the PIN is checked for validity. If the number is not correct, the PIN must be re-entered.

- If the PIN has been successfully entered (or the module PIN has not been enabled), the editor is displayed.







### 8.1.3 EDITING A PARAMETER

 **NOTE:** Pressing and holding the *Menu Navigation*  buttons provides the auto-repeat functionality. Values can be changed quickly by holding the navigation buttons for a prolonged period.



- Select the configuration that is required to be edit by pressing the **Up** or **Down**  buttons.



- Press the **Right** or **Left**  buttons to cycle to the section to view/change.
- Press the **Up** or **Down**  buttons to select the parameter to view/change within the currently selected section.
- To edit the parameter, press the **Tick**  button to enter edit mode. The parameter begins to flash to indicate editing.
- Press the **Up** or **Down**  buttons to change the parameter to the required value.
- Press the **Tick**  button to save the value. The parameter ceases flashing to indicate that it has been saved.

### 8.1.4 EXITING THE MAIN CONFIGURATION EDITOR

 **NOTE:** The editor automatically exits after 5 minutes of inactivity to ensure security.

- Press and hold the **Stop/Reset Mode**  button to exit the editor without saving changes.
- Press and hold the **Tick**  button to exit the editor and save the changes.

**8.1.5 ADJUSTABLE PARAMETERS**

Section	Parameter As Shown On Display	Value
<b>Display</b>	Contrast	0 %
	Language	English
	Current Date and Time	dd:mm:yyyy, hh:mm:ss
	Dual Mutual Mode	Set Priority / Run Time / Engine Hours
	Dual Mutual Priority	0
	Dual Mutual Duty Time	0 h 0 m 0 s
<b>Alt Config</b>	Config To Edit	Main Configuration / Alt Config 1,2,3,4, or 5
	Default Configuration	Main Configuration / Alt Config 1,2,3,4, or 5
<b>Engine</b>	Oil Pressure Low Shutdown	0.00 bar 0 psi 0 kPa
	Oil Pressure Low Pre-Alarm	0.00 bar 0 psi 0 kPa
	Coolant Temperature Low Warning	0 °C 0 °F
	Coolant Temperature High Pre Alarm	0 °C 0 °F
	Coolant Temperature High Electrical Trip	0 °C 0 °F
	Coolant Temperature High Shutdown	0 °C 0 °F
	Fuel Usage Running Rate	0 %
	Fuel Usage Stopped Rate	0 %
	Specific Gravity	0.00
	Pre Heat Temp	0 °C 0 °F
	Pre Heat Timer	0 h 0 m 0 s
	Post Heat Temp	0 °C 0 °F
	Post Heat Timer	0 h 0 m 0 s
	Droop Control	Active / Inactive
	Droop Control	0.0 %
	Crank Disconnect Oil Pressure Delay	0.0 s
	Crank Disconnect	0 V
	Under Speed Shutdown	Active / Inactive
	Under Speed Shutdown	0 RPM
	Under Speed Warning	Active / Inactive
	Under Speed Warning	0 RPM
	Under Speed Delay	0.0 s
	Over Speed Warning	Active / Inactive
	Over Speed Warning	0 RPM
	Over Speed Shutdown	0 RPM
	Over Speed Delay	0.0 s
	Overspeed Overshoot	0 %
	Overspeed Overshoot Delay	0 m 0.0 s
	Battery Under Voltage Warning	Active / Inactive
	Battery Under Voltage Warning	0.0 V
	Battery Under Voltage Warning Delay	0 h 0 m 0 s
	Battery Over Voltage Warning	Active / Inactive
	Battery Over Voltage Warning	0.0 V
	Battery Over Voltage Warning Delay	0 h 0 m 0 s
	Charge Alternator Failure Warning	Active / Inactive
	Charge Alternator Failure Warning	0.0 V
	Charge Alternator Warning Delay	0 h 0 m 0 s
	Charge Alternator Failure Shutdown	Active / Inactive
	Charge Alternator Failure Shutdown	0.0 V
	Charge Alternator Shutdown Delay	0 h 0 m 0 s
Inlet Temperature Shutdown	0 °C 0 °F	
Inlet Temperature Pre-Alarm	0 °C 0 °F	





Continued over page...

Front Panel Configuration

Section	Parameter As Shown On Display	Value
<b>Generator</b>	AC System	3 Phase, 4 Wire
	Under Voltage Shutdown	0 V
	Under Voltage Pre Alarm	0 V
	Under Voltage Delay	0.0 s
	Nominal Voltage	0 V
	Over Voltage Pre Alarm	0 V
	Over Voltage Shutdown	0 V
	Over Voltage Delay	0.0 s
	Under Frequency Shutdown	0.0 Hz
	Under Frequency Pre Alarm	0.0 Hz
	Under Frequency Delay	0.0 s
	Nominal Frequency	0.0 Hz
	Over Frequency Pre Alarm	0.0 Hz
	Over Frequency Shutdown	0.0 Hz
	Over Frequency Delay	0.0 s
	Frequency Overshoot	0 %
	Frequency Overshoot Delay	0.0 s
	CT Primary	0 A
	CT Secondary	0 A
	Earth CT Primary	0 A
	Full Load Rating	0 A
	Delayed Over Current	Active / Inactive
	Delayed Over Current	0 %
	Earth Fault Trip	Active / Inactive
	Earth Fault Trip	0 %
	kW Overload Trip	0 %
<b>Mains DSE7320 MKII Only</b>	AC System	3 Phase, 4 Wire
	Under Voltage Trip	0 V
	Over Voltage Trip	0 V
	Under Frequency Trip	0.0 Hz
	Over Frequency Trip	0.0 Hz
<b>Timers</b>	Start Delay Off Load	0 h 0 m 0 s
	Start Delay On Load	0 h 0 m 0 s
	Start Delay Mains Fail	0 h 0 m 0 s
	Start Delay Telemetry	0 h 0 m 0 s
	Mains Transient Delay	0 m 0 s
	Engine Cranking	0 m 0 s
	Engine Cranking Rest	0 m 0 s
	Engine Smoke Limiting	0 m 0 s
	Engine Smoke Limiting Off	0 m 0 s
	Engine Safety On Delay	0 m 0 s
	Engine Warming	0 h 0 m 0 s
	ECU Override	0 m 0 s
	Mains Transfer Time	0 m 0.0 s
	Return Delay	0 h 0 m 0 s
	Engine Cooling	0 h 0 m 0 s
	Engine Fail To Stop Delay	0 m 0 s
	LCD Page Delay	0 h 0 m 0 s
	LCD Scroll Delay	0 h 0 m 0 s
	Sleep Timer	0 h 0 m 0 s
	Backlight Timer	0 h 0 m 0 s

Continued over page...

Front Panel Configuration

Section	Parameter As Shown On Display	Value
Schedule	Schedule	Active / Inactive
	Schedule Period Bank 1	Weekly / Monthly
	On Load / Off Load / Auto Start Inhibit, Week, On, Run Time and Day Selection (1 to 8)	 Press <b>Tick</b>  to begin editing then up or down when selecting the different parameters in the scheduler.
	Schedule Period Bank 2	Weekly / Monthly
	On Load / Off Load / Auto Start Inhibit, Week, On, Run Time and Day Selection (1 to 8)	 Press <b>Tick</b>  to begin editing then up or down when selecting the different parameters in the scheduler.

## 8.2 'RUNNING' CONFIGURATION EDITOR

### 8.2.1 ACCESSING THE 'RUNNING' CONFIGURATION EDITOR

- The *Running Editor* is enterable whilst the generator is running. All protections remain active when the generator is running while the *Running Editor* is entered



- Press and hold the **Tick** button to access the *Running Editor*.

### 8.2.2 ENTERING PIN

**NOTE:** The PIN is not set by DSE when the module leaves the factory. If the module has a PIN code set, this has been affected by your engine supplier who should be contacted if you require the code. If the code has been 'lost' or 'forgotten', the module must be returned to the DSE factory to have the module's code removed. A charge is made for this procedure. NB - This procedure cannot be performed away from the DSE factory.

**NOTE:** The PIN is automatically reset when after exiting the editor (manually or automatically) to ensure security.

Even if a module security PIN has been set, the PIN is not requested whilst entering the *Running Editor*.

### 8.2.3 EDITING A PARAMETER

**NOTE:** Pressing and holding the *Menu Navigation* buttons provides the auto-repeat functionality. Values can be changed quickly by holding the navigation buttons for a prolonged period.



- Press the **Right** or **Left** buttons to cycle to the section to view/change.
- Press the **Up** or **Down** buttons to select the parameter to view/change within the currently selected section.
- To edit the parameter, press the **Tick** button to enter edit mode. The parameter begins to flash to indicate editing.
- Press the **Up** or **Down** buttons to change the parameter to the required value.
- Press the **Tick** button to save the value. The parameter ceases flashing to indicate that it has been saved.

## 8.2.4 EXITING THE 'RUNNING' CONFIGURATION EDITOR

 **NOTE:** The editor automatically exits after 5 minutes of inactivity to ensure security.



- Press and hold the **Tick** button to exit the editor and save the changes.

## 8.2.5 RUNNING EDITOR PARAMETERS

Section	Parameter As Shown On Display	Values
<b>Display</b>	Contrast	0 %
	Language	English
	Dual Mutual Status	Set Priority (1 to 8)
<b>Engine</b>	Manual Frequency Trim	0.0 Hz
	Speed Bias	0.0
	Governor Gain	0
	Frequency Adjust	0.0 %
	DPF Auto Regen Inhibit	Active / Inactive
	DPF Manual Regeneration Request	Active / Inactive
	ECU Service Mode	Active / Inactive
	<b>AVR</b>	Droop (% of Set Point)
	Proportional Set Point	0.0
	Integral Set Point	0.0
	Derivative Set Point	0.0
	Off Load Duty Cycle	0.0
	Maximum Duty Cycle	0.0
	Soft Start Ramp Start Point	0.0
	Soft Start Ramp Rate (%/Hz)	0.0
	Alternative Configuration	0
	Stability Selection	0

## 9 COMMISSIONING

### 9.1 BASIC CHECKS



 **NOTE: If Emergency Stop feature is not required, link the input to the DC Positive.**

Before the system is started, it is recommended that the following checks are made:



The unit is adequately cooled and all the wiring to the module is of a standard and rating compatible with the system. Check all mechanical parts are fitted correctly and that all electrical connections (including earths) are sound.

The unit DC supply is fused and connected to the battery and that it is of the correct polarity.

The Emergency Stop input is wired to an external normally closed switch connected to DC positive.

To check the start cycle operation, take appropriate measures to prevent the engine from starting (disable the operation of the fuel solenoid). After a visual inspection to ensure it is safe to proceed, connect the battery supply. Press the **Manual Mode**  button followed by the **Start**  button the unit start sequence commences.

The starter engages and operates for the pre-set crank period. After the starter motor has attempted to start the engine for the pre-set number of attempts, the LCD displays *Failed to Start*. Press the **Stop/Reset Mode**  button to reset the unit.

Restore the engine to operational status (reconnect the fuel solenoid). Press the **Manual Mode**  button followed by the **Start**  button. This time the engine should start, and the starter motor should disengage automatically. If not then check that the engine is fully operational (fuel available, etc.) and that the fuel solenoid is operating. The engine should now run up to operating speed. If not, and an alarm is present, check the alarm condition for validity, then check input wiring. The engine should continue to run for an indefinite period. It is possible at this time to view the engine and alternator parameters - refer to the 'Description of Controls' section of this manual.

Press the **Auto Mode**  button, the engine runs for the pre-set cooling down period, then stop. The generator should stay in the standby mode. If it does not, check that the *Remote Start* input is not active.

Initiate an automatic start by supplying the remote start signal (if configured). The start sequence commences, and the engine runs up to operational speed. Once the generator is available the delayed load outputs activate, the Generator accepts the load. If not, check the wiring to the delayed load output contactors. Check the Warming timer has timed out.

Remove the remote start signal. The return sequence begins. After the pre-set time, the generator is unloaded. The generator then runs for the pre-set cooling down period, then shutdown into its standby mode.

Set the modules internal clock/calendar to ensure correct operation of the scheduler and event logging functions. For details of this procedure see section entitled *Front Panel Configuration*.

If, despite repeated checking of the connections between the controller and the customer's system, satisfactory operation cannot be achieved, then contact DSE Technical Support Department:

**Tel:** +44 (0) 1723 890099

**Fax:** +44 (0) 1723 893303

**E-mail:** [support@deepseaelectronics.com](mailto:support@deepseaelectronics.com)

**Website:** [www.deepseaelectronics.com](http://www.deepseaelectronics.com)

## 9.2 CLOSED TRANSITION

**NOTE:** The following commissioning steps are not applicable to the DSE7310 MKII, they are only applicable to the DSE7320 MKII when *Closed Transition* has been enabled.

### 9.2.1 SYNC CHECKS

**CAUTION!** Failure to perform the Sync Check results in serious damage to the system (breakers, bus bars, alternators, engines etc) caused by out of sync closures.

Check to ensure that all the module's sensing cables have been connected to the correct phases and that the generator and mains switchgear has been correctly connected. Failing to perform such tests may lead to the DSE module sensing both sides of the switchgear as in sync.

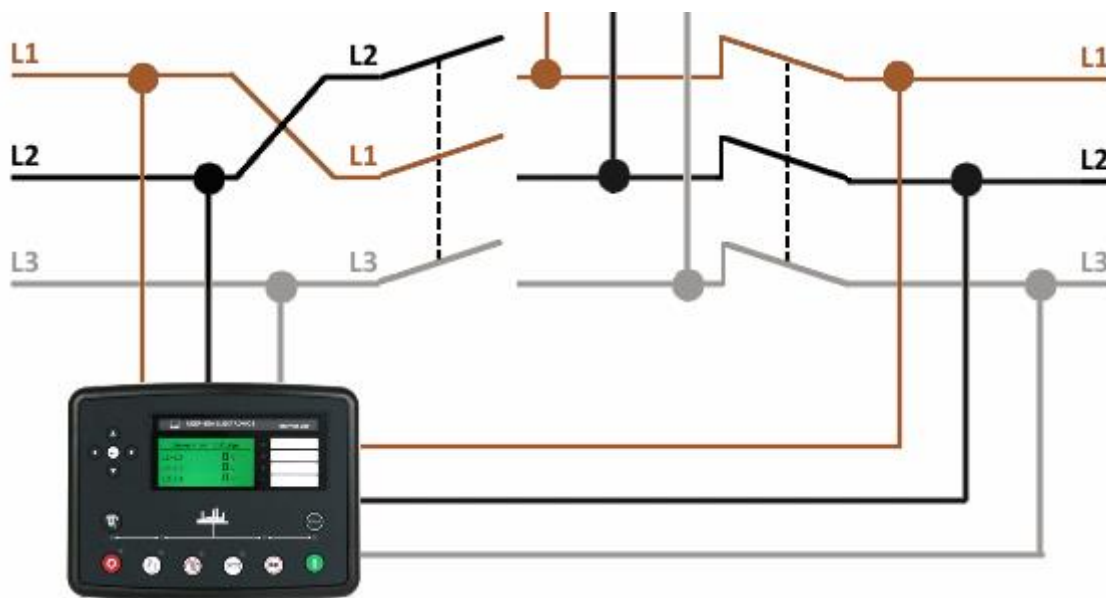

This is tested by starting the generator with the DSE module and ensuring the generator switchgear is left open (activate an input configured for *Generator Load Inhibit*). Then the load bus is to be made live, this is achieved by ensuring the mains switchgear is closed. Across the switchgear, connect a voltage meter to measure the AC voltage when the DSE module shows the two supplies in sync.



### 9.2.1.1 INCORRECTLY WIRED BREAKER

When the DSE module's synchroscope shows the two supplies in sync, if the voltage meter shows a voltage difference the switchgear is wired incorrectly. This is shown in the example below.

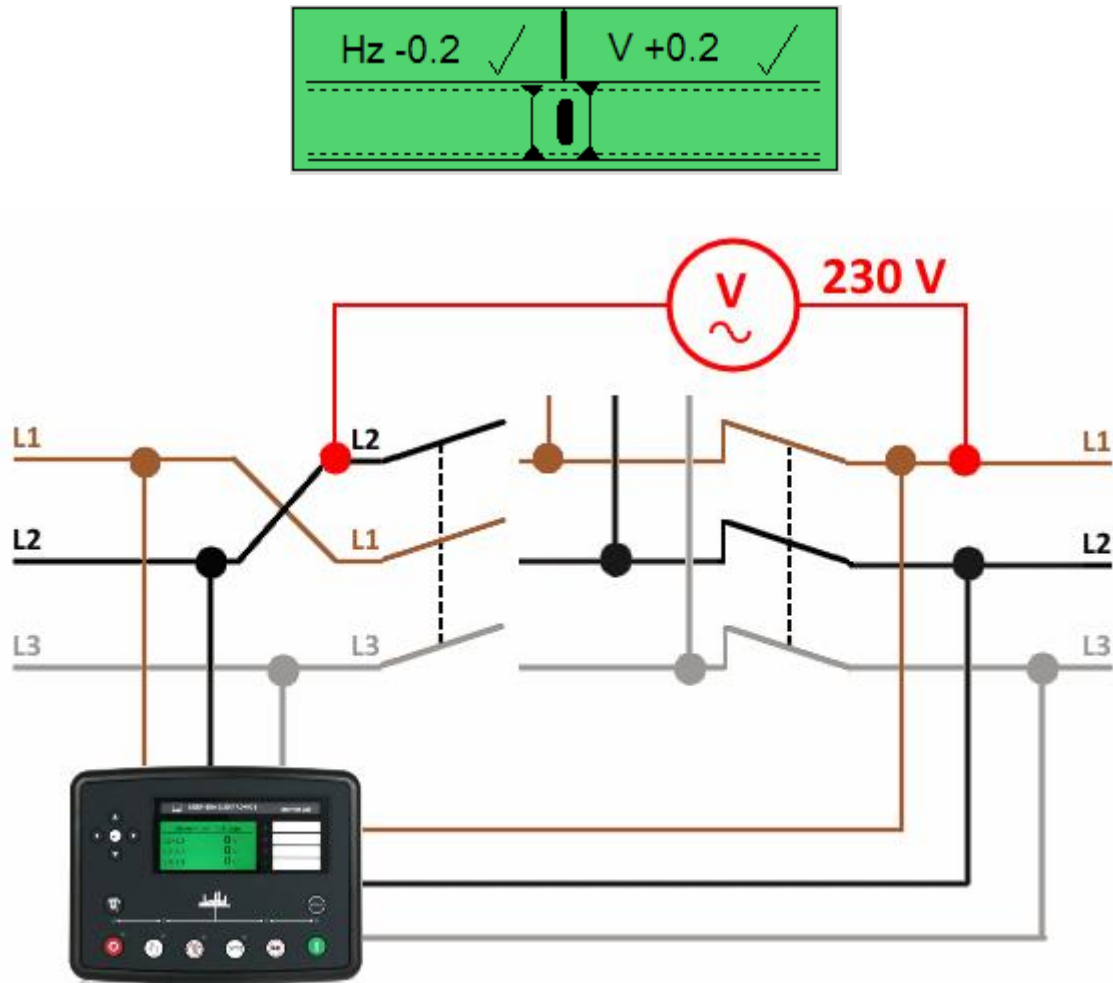

### 9.2.1.2 CORRECTLY WIRED BREAKER

When the DSE module's synchroscope shows the two supplies in sync, if the voltage meter shows no voltage difference the switchgear is wired correctly. This is shown in the example below.

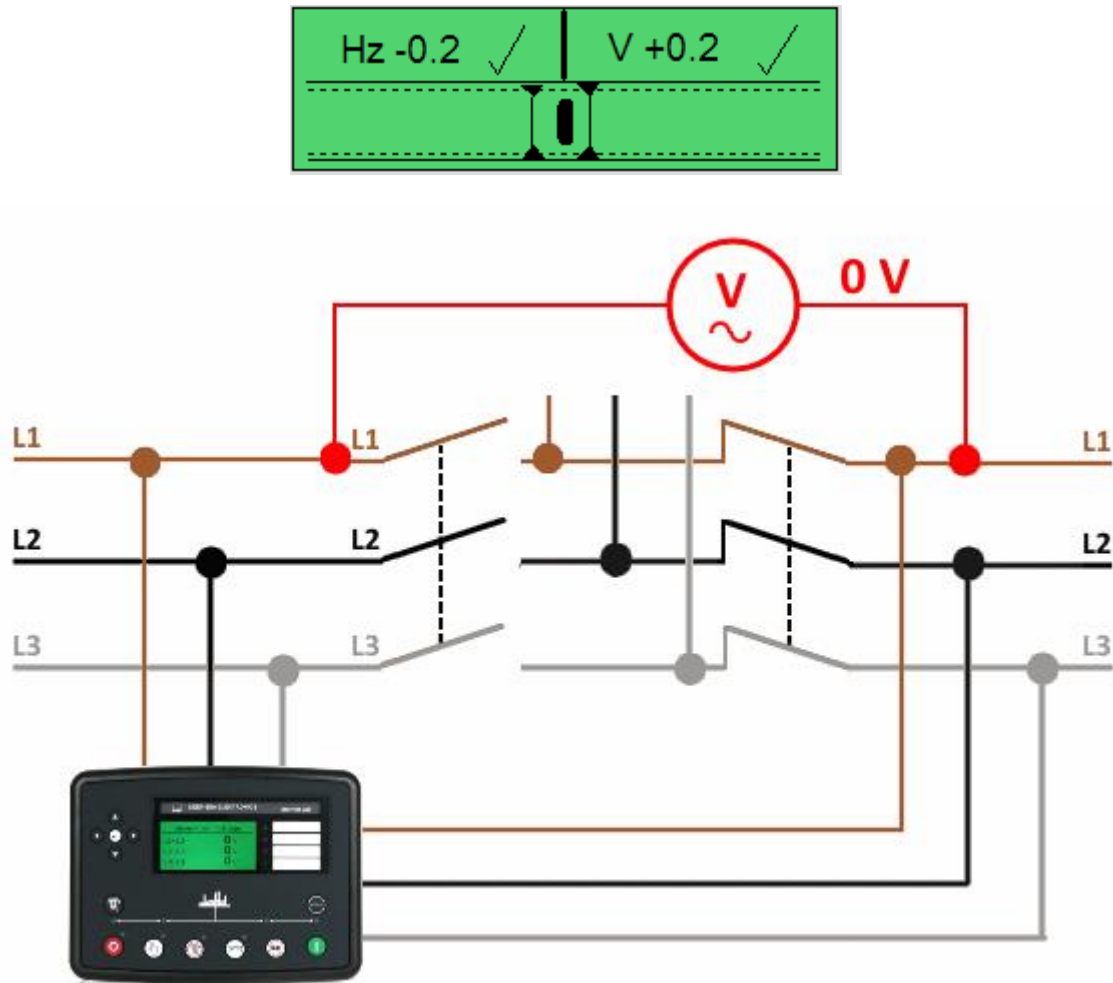

## 10 FAULT FINDING

 **NOTE:** The below fault finding is provided as a guide checklist only. As the module can be configured to provide a wide range of different features, always refer to the source of the module configuration if in doubt.

### 10.1 STARTING

Symptom	Possible Remedy
Unit is inoperative	Check the battery and wiring to the unit. Check the DC supply. Check the DC fuse.
Read/Write configuration does not operate	
Unit shuts down	Check DC supply voltage is not above 35 Volts or below 9 Volts Check the operating temperature is not above 70°C. Check the DC fuse.
Fail to Start is activated after pre-set number of attempts to start	Check wiring of fuel solenoid. Check fuel. Check battery supply. Check battery supply is present on the Fuel output of the module. Check the speed-sensing signal is present on the module's inputs. Refer to engine manual.
Continuous starting of generator when in the <b>Auto Mode</b> 	Check that there is no signal present on the "Remote Start" input. Check configured polarity is correct. Check the mains supply is available and within configured limits
Generator fails to start on receipt of Remote Start signal.	Check Start Delay timer has timed out.  Check signal is on "Remote Start" input. Confirm correct configuration of input is configured to be used as "Remote Start".  Check that the oil pressure switch or sensor is indicating low oil pressure to the controller. Depending upon configuration, the set does not start if oil pressure is not low.
Pre-heat inoperative	Check wiring to engine heater plugs. Check battery supply. Check battery supply is present on the Pre-heat output of module. Check pre-heat configuration is correct.
Starter motor inoperative	Check wiring to starter solenoid. Check battery supply. Check battery supply is present on the Starter output of module. Ensure oil pressure switch or sensor is indicating the "low oil pressure" state to the controller.

### 10.2 LOADING

Symptom	Possible Remedy
Engine runs but generator does not take load	Check Warm up timer has timed out. Ensure generator load inhibit signal is not present on the module inputs. Check connections to the switching device. Note that the set does not take load in <b>Manual Mode</b>  unless there is an active load signal.
Incorrect reading on Engine gauges	Check engine is operating correctly.
Fail to stop alarm when engine is at rest	Check that sensor is compatible with the module and that the module configuration is suited to the sensor.

### 10.3 ALARMS

Symptom	Possible Remedy
Oil pressure low fault operates after engine has fired	Check engine oil pressure. Check oil pressure switch/sensor and wiring. Check configured polarity (if applicable) is correct (i.e. Normally Open or Normally Closed) or that sensor is compatible with the module and is correctly configured.
Coolant temp high fault operates after engine has fired.	Check engine temperature. Check switch/sensor and wiring. Check configured polarity (if applicable) is correct (i.e. Normally Open or Normally Closed) or that sensor is compatible with the module.
Shutdown fault operates	Check relevant switch and wiring of fault indicated on LCD display. Check configuration of input.
Electrical Trip fault operates	Check relevant switch and wiring of fault indicated on LCD display. Check configuration of input.
Warning fault operates	Check relevant switch and wiring of fault indicated on LCD display. Check configuration of input.
ECU Amber ECU Red	This indicates a fault condition detected by the engine ECU and transmitted to the DSE controller.
ECU Data Fail	Indicates failure of the CAN data link to the engine ECU. Check all wiring and termination resistors (if required).
Incorrect reading on Engine gauges	Check engine is operating correctly. Check sensor and wiring paying particular attention to the wiring to terminal 14.
Fail to stop alarm when engine is at rest	Check that sensor is compatible with the module and that the module configuration is suited to the sensor.

### 10.4 COMMUNICATIONS

Symptom	Possible Remedy
ECU Data Fail	Indicates failure of the CAN data link to the engine ECU. Check all wiring and termination resistors (if required).

### 10.5 INSTRUMENTS

Symptom	Possible Remedy
Inaccurate generator measurements on controller display	<p>Check that the CT primary, CT secondary and VT ratio settings are correct for the application.</p> <p>Check that the CTs are wired correctly with regards to the direction of current flow (p1,p2 and s1,s2) and additionally ensure that CTs are connected to the correct phase (errors occur if CT1 is connected to phase 2).</p> <p>Remember to consider the power factor (<math>kW = kVA \times \text{powerfactor}</math>).</p> <p>The controller is true RMS measuring so gives more accurate display when compared with an 'averaging' meter such as an analogue panel meter or some lower specified digital multimeters.</p> <p>Accuracy of the controller is better than 1% of full scale. Generator voltage full scale is 415 V ph-N, accuracy is <math>\pm 4.15</math> V (1 % of 415 V).</p>

## 10.6 MISCELLANEOUS

Symptom	Possible Remedy
Module appears to 'revert' to an earlier configuration	<p>When editing a configuration using the PC software it is vital that the configuration is first 'read' from the controller before editing it. This edited configuration must then be "written" back to the controller for the changes to take effect.</p> <p>When editing a configuration using the fascia editor, be sure to press the <b>Tick</b>  button to save the change before moving to another item or exiting the fascia editor</p>

## 11 CAN INTERFACE SPECIFICATION (J1939-75)

The ECU port is used for live operational communications between the DSE module and other CAN enabled devices. The specification below details all broadcast messages which are transmitted when the J1939-75 is enabled, and the relevant engine file is selected.

Parameter	Description
Protocol	S.A.E. J1939 with PGNs as listed in the following subsections.
Bit Rate	250 kb/s
Isolation	±2.5 kVrms
Termination	120 Ω termination resistor, with the option for switchable resistor by software.

### 11.1 BROADCAST MESSAGES J1939-75

 **NOTE:** All broadcast CAN messages are priority 6 by default, it is not possible to change the priority of the configurable CAN messages. For further details of module configuration, refer to DSE Publication: 057- 224 DSE7310 MKII & DSE7310 MKII Configuration Software Manual.

 **NOTE:** SPNs that are not implemented in the module have all bits set to '1'.

 **NOTE:** *PDU Format* and *PDU Specific* are shown in Hexadecimal.

 **NOTE:** Values larger than 8 bits utilise *Little-Endian* format. For example, a 16-bit value, occupying two Bytes has Byte1 as the least significant Byte and Byte2 as the most significant Byte.

Parameter Groups below are broadcast by the module and are detailed in the following subsections.

11.1.1 ACS - AC SWITCHING DEVICE STATUS

PGN 64913

Priority	Ext Data Page	Data Page	PDU Format	PDU Specific	Size (Bytes)	Rate
6	0	0	FD	91	8	250 ms

SPN		Instrument	Byte / Bit	Scaling	Offset	Units
Hex	Decimal					
0DD9	3545	Generator Breaker Status - This parameter indicates the measured state of the generator circuit breaker	Byte 1 Bits 1 to 3	<b>000</b> : Open <b>001</b> : Closed <b>010</b> : Locked Out <b>011-101</b> : Available for SAE assignment <b>110</b> : Error <b>111</b> : Not available	0	N/A
0DDA	3546	Utility Circuit Breaker Status - This parameter indicates the measured state of the utility circuit breaker.	Byte 1 Bits 4 to 6	<b>000</b> : Open <b>001</b> : Closed <b>010</b> : Locked Out <b>011-101</b> : Available for SAE assignment <b>110</b> : Error <b>111</b> : Not available	0	N/A

11.1.2 GC1 - GENERATOR CONTROL 1

PGN 64915

Priority	Ext Data Page	Data Page	PDU Format	PDU Specific	Size (Bytes)	Rate
6	0	0	FD	93	8	100 ms

SPN		Instrument	Byte / Bit	Scaling	Offset	Units
Hex	Decimal					
0DEF	3567	Generator Control Not In Automatic Start State - This parameter indicates whether the generator set is in a condition to automatically start up and provide power. If not, this status parameter is in the ACTIVE state.	Byte 1 Bits 4 to 5	<b>00</b> : Inactive (ready to start automatically) <b>01</b> : Active (not ready to start automatically) <b>10</b> : Error <b>11</b> : Not available	0	N/A

**11.1.3 GAAC - GENERATOR AVERAGE BASIC AC QUANTITIES****PGN 65030**

Priority	Ext Data Page	Data Page	PDU Format	PDU Specific	Size (Bytes)	Rate
6	0	0	FE	06	8	100 ms

SPN						
Hex	Decimal	Instrument	Byte / Bit	Scaling	Offset	Units
0988	2440	Generator Avg. L-L AC Voltage	Byte 1 to 2	1	0	V
098C	2444	Generator Avg. L-N AC Voltage	Byte 3 to 4	1	0	V
0984	2436	Generator Avg. AC Frequency	Byte 5 to 6	1/128 Hz/bit	0	Hz
0990	2448	Generator Avg. AC RMS Current	Byte 7 to 8	1	0	A

**11.1.4 GPAAC - GENERATOR PHASE A BASIC AC QUANTITIES****PGN 65027**

Priority	Ext Data Page	Data Page	PDU Format	PDU Specific	Size (Bytes)	Rate
6	0	0	FE	03	8	100 ms

SPN						
Hex	Decimal	Instrument	Byte / Bit	Scaling	Offset	Units
0985	2437	Generator Phase A AC Frequency	Byte 5 to 6	128	0	V
0989	2441	Generator Phase A Line Line AC RMS Voltage	Byte 1 to 2	1	0	V
098D	2445	Generator Phase A Line Neutral AC RMS Voltage	Byte 3 to 4	1	0	A
0991	2449	Generator Phase A AC RMS Current	Byte 7 to 8	1	0	Hz

**11.1.5 GPAACP - GENERATOR PHASE A AC POWER****PGN 65026**

Priority	Ext Data Page	Data Page	PDU Format	PDU Specific	Size (Bytes)	Rate
6	0	0	FE	02	8	100 ms

SPN						
Hex	Decimal	Instrument	Byte / Bit	Scaling	Offset	Units
0993	2453	Generator Phase A Real Power	Byte 1 to 4	1	-2*10 <sup>9</sup>	W
099D	2461	Generator Phase A Apparent Power	Byte 5 to 8	1	-2*10 <sup>9</sup>	W



**11.1.6 GPAACR - GENERATOR PHASE A AC REACTIVE POWER****PGN 65025**

Priority	Ext Data Page	Data Page	PDU Format	PDU Specific	Size (Bytes)	Rate
6	0	0	FE	00	8	100 ms

SPN						
Hex	Decimal	Instrument	Byte / Bit	Scaling	Offset	Units
0999	2457	Generator Phase A Reactive Power	Byte 1 to 4	1	-2*10 <sup>9</sup>	var

**11.1.7 GPBAC - GENERATOR PHASE B BASIC AC QUANTITIES****PGN 65024**

Priority	Ext Data Page	Data Page	PDU Format	PDU Specific	Size (Bytes)	Rate
6	0	0	FE	00	8	100 ms

SPN						
Hex	Decimal	Instrument	Byte / Bit	Scaling	Offset	Units
0986	2438	Generator Phase B AC Frequency	Byte 5 to 6	0.0078125	0	Hz
098A	2442	Generator Phase B Line Line AC RMS Voltage	Byte 1 to 2	1	0	V
098E	2446	Generator Phase B Line Neutral AC RMS Voltage	Byte 3 to 4	1	0	V
0992	2450	Generator Phase B AC RMS Current	Byte 7 to 8	1	0	A

**11.1.8 GPBACP - GENERATOR PHASE B AC POWER****PGN 65023**

Priority	Ext Data Page	Data Page	PDU Format	PDU Specific	Size (Bytes)	Rate
6	0	0	FD	FF	8	100 ms

SPN						
Hex	Decimal	Instrument	Byte / Bit	Scaling	Offset	Units
0996	2454	Generator Phase B Real Power	Byte 1 to 4	1	-2*10 <sup>9</sup>	W
099E	2462	Generator Phase B Apparent Power	Byte 5 to 8	1	-2*10 <sup>9</sup>	W

**11.1.9 GPBACR - GENERATOR PHASE B AC REACTIVE POWER****PGN 65022**

Priority	Ext Data Page	Data Page	PDU Format	PDU Specific	Size (Bytes)	Rate
6	0	0	FD	FE	8	100 ms

SPN		Instrument	Byte / Bit	Scaling	Offset	Units
Hex	Decimal					
099A	2458	Generator Phase B Reactive Power	Byte 1 to 4	1	-2*10 <sup>9</sup>	var

**11.1.10 GPCAC - GENERATOR PHASE C BASIC AC QUANTITIES****PGN 65021**

Priority	Ext Data Page	Data Page	PDU Format	PDU Specific	Size (Bytes)	Rate
6	0	0	FD	FD	8	100 ms

SPN		Instrument	Byte / Bit	Scaling	Offset	Units
Hex	Decimal					
0987	2439	Generator Phase C AC Frequency	Byte 5 to 6	0.0078125	0	Hz
098B	2443	Generator Phase C Line Line AC RMS Voltage	Byte 1 to 2	1	0	V
098F	2447	Generator Phase C Line Neutral AC RMS Voltage	Byte 3 to 4	1	0	V
0993	2451	Generator Phase C AC RMS Current	Byte 7 to 8	1	0	A

**11.1.11 GPCACP - GENERATOR PHASE C AC POWER****PGN65020**

Priority	Ext Data Page	Data Page	PDU Format	PDU Specific	Size (Bytes)	Rate
6	0	0	FD	FF	8	100 ms

SPN		Instrument	Byte / Bit	Scaling	Offset	Units
Hex	Decimal					
0997	2455	Generator Phase C Real Power	Byte 1 to 4	1	-2*10 <sup>9</sup>	W
099F	2463	Generator Phase C Apparent Power	Byte 5 to 8	1	-2*10 <sup>9</sup>	W

**11.1.12 GPCACR - GENERATOR PHASE C AC REACTIVE POWER**

**PGN 65019**

Priority	Ext Data Page	Data Page	PDU Format	PDU Specific	Size (Bytes)	Rate
6	0	0	FD	FB	8	100 ms

SPN						
Hex	Decimal	Instrument	Byte / Bit	Scaling	Offset	Units
099B	2459	Generator Phase C Reactive Power	Byte 1 to 4	1	-2*10 <sup>9</sup>	var

**11.1.13 GTACPP - GENERATOR TOTAL AC PERCENT POWER**

**PGN 64911**

Priority	Ext Data Page	Data Page	PDU Format	PDU Specific	Size (Bytes)	Rate
6	0	0	FD	8F	8	250 ms

SPN						
Hex	Decimal	Instrument	Byte / Bit	Scaling	Offset	Units
0E06	3590	Generator Total Percent kW as a percentage of rated power	Byte 1 to 2	0.0078125	-251	%

**11.1.14 GTACE - GENERATOR TOTAL KW HOURS EXPORT**

**PGN 65018**

Priority	Ext Data Page	Data Page	PDU Format	PDU Specific	Size (Bytes)	Rate
6	0	0	FD	FA	8	100 ms

SPN						
Hex	Decimal	Instrument	Byte / Bit	Scaling	Offset	Units
09A4	2468	Generator Total kW Hours Export	Byte 1 to 4	1	0	kWh

**11.1.15 GTACER - GENERATOR TOTAL AC REACTIVE ENERGY**

**PGN64910**

Priority	Ext Data Page	Data Page	PDU Format	PDU Specific	Size (Bytes)	Rate
6	0	0	FD	8E	8	250 ms

SPN						
Hex	Decimal	Instrument	Byte / Bit	Scaling	Offset	Units
0E09	3593	Generator Total kVAr Hours Export	Byte 1 to 4	1	0	kvarh

**11.1.16 GTACP - GENERATOR TOTAL AC POWER****PGN65029**

Priority	Ext Data Page	Data Page	PDU Format	PDU Specific	Size (Bytes)	Rate
6	0	0	FE	05	8	100 ms

SPN						
Hex	Decimal	Instrument	Byte / Bit	Scaling	Offset	Units
0994	2452	Generator Total Real Power	Byte 1 to 4	1	-2*10 <sup>9</sup>	W
099C	2460	Generator Total Apparent Power	Byte 5 to 8	1	-2*10 <sup>9</sup>	VA

**11.1.17 GTACR - GENERATOR TOTAL AC REACTIVE POWER****PGN65028**

Priority	Ext Data Page	Data Page	PDU Format	PDU Specific	Size (Bytes)	Rate
6	0	0	FE	04	8	100 ms

SPN						
Hex	Decimal	Instrument	Byte / Bit	Scaling	Offset	Units
0988	2456	Generator Total Reactive Power	Byte 1 to 4	1	-2*10 <sup>9</sup>	var
09A0	2464	Generator Overall Power Factor	Byte 5 to 6	-1	6.103515625*10 <sup>-5</sup>	pF
09D6	2518	Generator Overall Power Factor Lagging	Byte 7 to 8	1	0	+/-

**11.2 BROADCAST MESSAGES ENGINE INSTRUMENTATION**

 **NOTE:** The availability of the Engine Instrumentation PGNs are dependent upon the engine file selected within the DSE module's configuration. Contact DSE technical support: [support@deepseaelectronics.com](mailto:support@deepseaelectronics.com) for more information.

**11.2.1 DD - DASH DISPLAY****PGN 65276**

Priority	Ext Data Page	Data Page	PDU Format	PDU Specific	Size (Bytes)	Rate
6	0	0	FE	FC	8	1000 ms

SPN						
Hex	Decimal	Instrument	Byte / Bit	Scaling	Offset	Units
060	96	Ratio of volume of fuel to the total volume of fuel storage container.	Byte 2	0.4	0	%

**11.2.2 EC2 - ENGINE CONFIGURATION 2****PGN64895**

Priority	Ext Data Page	Data Page	PDU Format	PDU Specific	Size (Bytes)	Rate
6	0	0	FD	7F	8	Request

SPN		Instrument	Byte / Bit	Scaling	Offset	Units
Hex	Decimal					
0E56	3670	Maximum Crank Attempts per Start Attempt	Byte 1	1	0	N/A

**11.2.3 EEC1- ENGINE SPEED****PGN61444**

Priority	Ext Data Page	Data Page	PDU Format	PDU Specific	Size (Bytes)	Rate
6	0	0	F0	04	8	100 ms

SPN		Instrument	Byte / Bit	Scaling	Offset	Units
Hex	Decimal					
0BE	190	Engine Speed	Byte 4 to 5	0.125	0	RPM

**11.2.4 EEC4 - CRANK ATTEMPT COUNT ON PRESENT START ATTEMPT****PGN65214**

Priority	Ext Data Page	Data Page	PDU Format	PDU Specific	Size (Bytes)	Rate
6	0	0	FE	FB	8	Request

SPN		Instrument	Byte / Bit	Scaling	Offset	Units
Hex	Decimal					
0E57	3671	Crank Attempt Count on Present Start Attempt	Byte 6	1	0	N/A

**11.2.5 EFL\_P1 - OIL PRESSURE****PGN65263**

Priority	Ext Data Page	Data Page	PDU Format	PDU Specific	Size (Bytes)	Rate
6	0	0	FE	EF	8	500 ms

SPN		Instrument	Byte / Bit	Scaling	Offset	Units
Hex	Decimal					
064	100	Oil Pressure	Byte 4	4	0	kPa

**11.2.6 EOI - EMERGENCY STOP**

**PGN64914**

Priority	Ext Data Page	Data Page	PDU Format	PDU Specific	Size (Bytes)	Rate
6	0	0	FD	92	8	250 ms

SPN							
Hex	Decimal	Instrument	Byte / Bit	Scaling	Offset	Units	
0E17	3607	Emergency Stop <b>00:</b> Off (No Shutdown Requested) <b>01:</b> On (Shutdown Requested) <b>10:</b> Reserved <b>11:</b> Don't care / take no action	Byte 6 Bit 6 to 8	1	0	N/A	

**11.2.7 ET1 - COOLANT TEMPERATURE**

**PGN65262**

Priority	Ext Data Page	Data Page	PDU Format	PDU Specific	Size (Bytes)	Rate
6	0	0	FE	EE	8	1000 ms

SPN							
Hex	Decimal	Instrument	Byte / Bit	Scaling	Offset	Units	
06E	110	Engine Coolant Temperature	Byte 1	1	-40	°C	

**11.2.8 HOURS - ENGINE HOURS REVOLUTIONS**

**PGN65253**

Priority	Ext Data Page	Data Page	PDU Format	PDU Specific	Size (Bytes)	Rate
6	0	0	FE	E5	8	Request

SPN							
Hex	Decimal	Instrument	Byte / Bit	Scaling	Offset	Units	
0F7	247	Engine Total Hours of Operation	Byte 1 to 4	0.05	0	hr	

**11.2.9 VEP1 - VEHICLE ELECTRICAL POWER**

**PGN65271**

Priority	Ext Data Page	Data Page	PDU Format	PDU Specific	Size (Bytes)	Rate
6	0	0	FE	F7	8	1000 ms

SPN							
Hex	Decimal	Instrument	Byte / Bit	Scaling	Offset	Units	
0A7	167	Charge Alternator Voltage	Byte 3 to 4	0.05	0	V	
0A8	168	Plant Battery Voltage	Byte 5 to 6	0.05	0	V	

**11.2.10 DM01 - CONDITIONS ACTIVE DIAGNOSTIC TROUBLE CODES**

**NOTE:** The availability of the Engine Alarm SPN and FMI is dependent upon the engine file selected within the DSE module's configuration. Contact DSE technical support: [support@deepseaelectronics.com](mailto:support@deepseaelectronics.com) for more information.

**NOTE:** If only one DM1 alarm is active the DM1 priority will remain as six. If two or more DM1 alarms are active the priority will be seven.

**PGN65226**

Priority	Ext Data Page	Data Page	PDU Format	PDU Specific	Size (Bytes)	Rate
6/7	0	0	FE	CA	8	1000 ms

SPN		Instrument	Byte / Bit	Scaling	Offset	Units
Hex	Decimal					
04BE	1214	Suspect Parameter Number	Byte 3 Bits 1 to 19	1	0	N/A
04BF	1215	Failure Mode Identifier	Byte 5 Bits 1 to 5	1	0	N/A
06AA	1706	SPN Conversion Method	Byte 6 Bit 7	1	0	N/A

**DM1 Conditions**

Key	Value
Low Fault - Least Severe	17
High Fault - Least Severe	15
Low Fault - Most Severe	1
High Fault - Most Severe	0
Erratic - Incorrect Data	2

Generator Alarm Condition	SPN	Warning FMI	Shutdown FMI
Generator Average AC Frequency Under	2436	17	1
SPN Generator Average Line-Line AC RMS Voltage Over	2436	15	0
Generator Average Line-Line AC RMS Voltage Under	2440	17	1
Generator Average Line-Line AC RMS Voltage Over	2440	15	0
Generator Average Line-Neutral AC RMS Voltage Under	2444	17	1
Generator Average Line-Neutral AC RMS Voltage Over	2444	15	0
Generator Average AC RMS Current Over	2448	15	0

Parameters continued overleaf...

CAN Interface Specification (J1939-75)

<b>Engine Alarm Condition</b>	<b>SPN</b>	<b>Warning FMI</b>	<b>Shutdown FMI</b>
Fuel Level Low	96	17	1
Oil Pressure Low (Analogue Sensor)	100	17	1
Oil Pressure Low (Digital Input)	100	17	1
Oil Pressure Sensor Fault	100	2	2
Coolant Temperature High (Analogue Sensor)	110	15	0
Coolant Temperature High (Digital Input)	110	15	0
Coolant Temperature Sensor Fault	110	2	2
Charge Alternator Failed	167	17	1
Plant Battery Voltage High	168	15	0
Plant Battery Voltage Low	168	17	1
Overspeed	190	15	0
Underspeed	190	17	1



## 12 MAINTENANCE, SPARES, REPAIR AND SERVICING

The controller is *Fit and Forget*. As such, there are no user serviceable parts within the controller. In the case of malfunction, you should contact your original equipment manufacturer (OEM).







### 12.1 PURCHASING ADDITIONAL CONNECTOR PLUGS FROM DSE

If you require additional plugs from DSE, please contact our Sales department using the part numbers below.

#### 12.1.1 PACK OF PLUGS

Module Type	Plug Pack Part Number
DSE7310 MKII	007-877
DSE7320 MKII	007-876

### 12.1.2 INDIVIDUAL PLUGS

Module Terminal Designation	Plug Description	Part No.
1 to 13 	13 way 5.08 mm	007-166
14 to 20 	7 way 5.08 mm	007-447
21 to 29  ECU	9 way 5.08 mm	007-167
30 to 37  V1	8 way 7.62 mm	007-454
38 to 41 <b>V2</b> DSE7320 MKII Only	4 way 7.62 mm	007-171
42 to 47 	6 way 5.08 mm	007-446
48 to 55 	8 way 5.08 mm	007-164
56 to 58 <b>RS485</b>	6 way 5.08 mm	007-446
	PC Configuration interface lead (USB type A – USB type B)	016-125

### 12.2 PURCHASING ADDITIONAL FIXING CLIPS FROM DSE

Item	Description	Part No.
	Module Fixing Clips (Packet of 4)	020-294

### 12.3 PURCHASING ADDITIONAL SEALING GASKET FROM DSE

Item	Description	Part No.
	Module Silicon Sealing Gasket	020-564





## 12.4 DSENET® EXPANSION MODULES

**NOTE:** A maximum of twenty (20) expansion modules and DSE Intelligent Battery Chargers can be connected to the DSE7310 MKII & DSE7320 MKII DSENet® Port.





**NOTE:** When connecting a DSE25xx MKII Remote Display on DSENet, the maximum number of supported expansion modules reduces from 20 down to 5 (including only 1 battery charger).

**NOTE:** The DSENet® port is also used to connect to the Battery Chargers. This document does not cover the Battery Chargers ranges. For more information about the Battery Chargers refer to the relevant Chargers Operators and Software manuals.

**NOTE:** DSENet® utilises an RS485 connection. Using Belden 9841 (or equivalent) cable allows for the expansion cable to be extended to a maximum of 1.2 km. DSE Stock and supply Belden 9841 cable. DSE Part Number 016-030.

Item	Max No. Supported	Description	DSE Part Numbers		
			Model Order Number	Operator Manual	Installation Instructions
	4	Model DSE2130 input module provides additional analogue and digital inputs for use with the controller.	2130-01	057-082	053-033
	4	Model DSE2131 Ratio-metric input expansion module provides additional resistive, digital, 0 V to 10 V and 4 mA to 20mA inputs for use with the controller.	2131-01	055-115	057-139
	4	Model DSE2133 RTD/Thermocouple input expansion module provides additional RTD and thermocouple inputs for use with the controller.	2133-01	055-114	057-140
	4	Model DSE2152 Ratio-metric output expansion module provides additional 0 V to 10 V and 4 mA to 20mA outputs for use with the controller.	2152-01	055-112	057-141

Expansion modules continued overleaf...

Item	Max No. Supported	Description	DSE Part Numbers		
			Model Order Number	Operator Manual	Installation Instructions
	10	Model DSE2157 expansion relay module provides eight additional voltage free relays for use with the controller	2157-01	057-083	053-034
	10	Model DSE2548 expansion LED module provides additional LED indications, internal sounder and remote lamp test/alarm mute for use with the controller.	2548-01	057-084	053-032
	1	Model DSE25xx MKII Expansion Display modules provide remote control / display capability for the DSE74xx MKII controllers. A DSE25xx MKII is a standard DSE73xx MKII unit after a firmware upgrade.  DSE2510 MKII is for DSE7410 MKII DSE2520 MKII is for DSE7420 MKII	7310-03 7320-03	057-278	-
	4	Intelligent Battery Charger monitored over the DSENet® Port.	-	-	-

## 13 WARRANTY

DSE Provides limited warranty to the equipment purchaser at the point of sale. For full details of any applicable warranty, refer to the original equipment supplier (OEM)

## 14 DISPOSAL

### 14.1 WEEE (WASTE ELECTRICAL AND ELECTRONIC EQUIPMENT)

If you use electrical and electronic equipment you must store, collect, treat, recycle, and dispose of WEEE separately from your other waste.



*This Page is Intentionally Blank*