

**COMPLEX
SOLUTIONS
MADE
SIMPLE.**



DSEPOWER[®]

DSE8680 Control Module

Document number 057-130

Author : Anthony Manton



Deep Sea Electronics Plc
Highfield House
Hunmanby
North Yorkshire
YO14 0PH
ENGLAND

Sales Tel: +44 (0) 1723 890099
Sales Fax: +44 (0) 1723 893303

E-mail: sales@deepseapl.com
Website: www.deepseapl.com

DSE Model 8680 Bus Tie Controller Operator Manual

© Deep Sea Electronics Plc

All rights reserved. No part of this publication may be reproduced in any material form (including photocopying or storing in any medium by electronic means or other) without the written permission of the copyright holder except in accordance with the provisions of the Copyright, Designs and Patents Act 1988.

Applications for the copyright holder's written permission to reproduce any part of this publication should be addressed to Deep Sea Electronics Plc at the address above.

The DSE logo and the names DSEUltra, DSEPower, DSEPower, DSEExtra, DSEMarine and DSENet are UK registered trademarks of Deep Sea Electronics PLC.

Any reference to trademarked product names used within this publication is owned by their respective companies.

Deep Sea Electronics Plc reserves the right to change the contents of this document without prior notice.

Amendments since last publication

Issue no.	Comments
1	Initial Release

Clarification of notation used within this publication.



 NOTE:	Highlights an essential element of a procedure to ensure correctness.
 CAUTION!	Indicates a procedure or practice, which, if not strictly observed, could result in damage or destruction of equipment.
 WARNING!	Indicates a procedure or practice, which could result in injury to personnel or loss of life if not followed correctly.

TABLE OF CONTENTS

Section	Page
1 BIBLIOGRAPHY.....	5
1.1 INSTALLATION INSTRUCTIONS.....	5
1.2 TRAINING GUIDES	5
1.3 MANUALS	5
2 INTRODUCTION.....	6
3 SPECIFICATIONS.....	7
3.1 PART NUMBERING	7
3.1.1 SHORT NAMES.....	7
3.2 TERMINAL SPECIFICATION.....	8
3.3 POWER SUPPLY REQUIREMENTS	8
3.4 BUS 1 AND BUS 2 VOLTAGE / FREQUENCY SENSING	8
3.5 INPUTS	10
3.5.1 DIGITAL INPUTS	10
3.6 OUTPUTS	10
3.6.1 OUTPUTS A & B.....	10
3.6.2 OUTPUTS C & D.....	10
3.6.3 OUTPUTS E,F,G,H,I & J.....	10
3.7 COMMUNICATION PORTS	10
3.7.1 COMMUNICATION PORT USAGE	12
3.7.1.1 USB CONNECTION.....	12
3.7.1.2 RS232.....	13
3.7.1.3 RS485.....	15
3.7.1.4 ETHERNET.....	16
3.8 DSENET® FOR EXPANSION MODULES.....	17
3.9 SOUNDER.....	18
3.9.1 ADDING AN EXTERNAL SOUNDER TO THE APPLICATION.....	18
3.10 DIMENSIONS AND MOUNTING	19
3.10.1.1 DIMENSIONS.....	19
3.10.2 CABLE TIE FIXING POINTS.....	21
3.10.3 SILICON SEALING GASKET	21
3.11 APPLICABLE STANDARDS.....	22
3.11.1 ENCLOSURE CLASSIFICATIONS.....	23
IP CLASSIFICATIONS	23
NEMA CLASSIFICATIONS	24
4 INSTALLATION.....	25
4.1 TERMINAL DESCRIPTION	25
4.1.1 DC SUPPLY, FUEL AND START OUTPUTS	25
4.1.2 MAGNETIC PICKUP, CAN AND EXPANSION	26
4.1.3 LOAD SWITCHING AND BUS 1 SENSING (V1)	27
4.1.4 BUS 2 SENSING (V2).....	27
4.1.5 CONFIGURABLE DIGITAL INPUTS	28
4.1.6 PC CONFIGURATION INTERFACE CONNECTOR.....	28
4.1.7 RS485 CONNECTOR.....	29
4.1.8 RS232 CONNECTOR.....	29
4.2 TYPICAL WIRING DIAGRAMS.....	30
4.2.1 DSENET®.....	32
5 DESCRIPTION OF CONTROLS.....	33
5.1 VIEWING THE INSTRUMENT PAGES.....	34
5.1.1 STATUS.....	35
5.1.2 BUS 1	36
5.1.3 BUS 2	36
5.1.4 SERIAL PORT.....	36

- 5.1.5 ABOUT.....40
- 5.2 VIEWING THE EVENT LOG.....41
- 5.3 USER CONFIGURABLE INDICATORS42
- 5.4 CONTROLS.....43
- 6 OPERATION..... 44
 - 6.1 AUTOMATIC MODE.....44
 - 6.2 MANUAL MODE.....44
- PROTECTIONS..... 45
 - 6.3 INDICATIONS.....45
 - 6.4 WARNINGS.....46
 - 6.5 ELECTRICAL TRIPS.....46
 - 6.6 FRONT PANEL CONFIGURATION.....47
 - 6.7 ACCESSING THE 'RUNNING' CONFIGURATION EDITOR.....47
 - 6.7.1 EDITING A PARAMETER47
 - 6.7.2 ADJUSTABLE PARAMETERS (RUNNING EDITOR)47
- 7 MAINTENANCE, SPARES, REPAIR AND SERVICING 49
 - 7.1.1.1 INDIVIDUAL PLUGS49
 - 7.2 PURCHASING ADDITIONAL FIXING CLIPS FROM DSE49
 - 7.3 PURCHASING ADDITIONAL SEALING GASKET FROM DSE.....49
 - 7.4 EXPANSION MODULES50
- 8 WARRANTY..... 51
- 9 DISPOSAL 51
 - 9.1 WEEE (WASTE ELECTRICAL AND ELECTRONIC EQUIPMENT).....51
 - 9.2 ROHS (RESTRICTION OF HAZARDOUS SUBSTANCES)51

1 BIBLIOGRAPHY

This document refers to and is referred to by the following DSE publications which can be obtained from the DSE website www.deepseapl.com

1.1 INSTALLATION INSTRUCTIONS

Installation instructions are supplied with the product in the box and are intended as a 'quick start' guide only.

DSE PART	DESCRIPTION
053-069	DSE8610 Installation Instructions
053-073	DSE8700 Installation Instructions
053-032	DSE2548 LED Expansion Annunciator Installation Instructions
053-033	DSE2130 Input Expansion Installation Instructions
053-034	DSE2157 Output Expansion Installation Instructions
053-082	DSE8680 Installation Instructions

1.2 TRAINING GUIDES

Training Guides are produced to give 'handout' sheets on specific subjects during training sessions.

DSE PART	DESCRIPTION
056-022	Breaker Control
056-030	Module PIN Codes
056-047	Fail to close and out of sync

1.3 MANUALS

DSE PART	DESCRIPTION
057-082	DSE2130 Input Expansion Manual
057-083	DSE2157 Output Expansion Manual
057-084	DSE2548 Annunciator Expansion Manual
057-115	DSE8610 Operator Manual
057-119	DSE8600 Series Configuration Software Manual
057-124	DSE8710 Operator Manual
057-127	DSE8710 Configuration Software Manual
057-131	DSE8680 Bus Tie Controller Configuration Software Manual

2 INTRODUCTION

This document details the installation and operation requirements of the DSE8680 bus tie controller, part of the DSEPower® range of products.

The manual forms part of the product and should be kept for the entire life of the product. If the product is passed or supplied to another party, ensure that this document is passed to them for reference purposes.

This is not a *controlled document*. You will not be automatically informed of updates. Any future updates of this document will be included on the DSE website at www.deepseapl.com

DSE8680 bus tie controller is compatible with **DSE8600** and **DSE8700** series controllers.

The **DSE8600 and DSE8700 series** are designed to provide differing levels of functionality across a common platform. This allows the generator OEM greater flexibility in the choice of controller to use for a specific application.

The **DSE8680** module has been designed to control a bus tie breaker. A bus tie breaker separates two halves of a generator common bus. The DSE8680 manages this breaker, manages the synchronising and check synch across the breaker and automatically controls the DSE MSC (Multi Set Communications) Link when opening/closing the bus tie breaker.

The user also has the facility to view the system operating parameters via the LCD display.

The powerful ARM microprocessor contained within the module allows for incorporation of a range of complex features:

- *Text based LCD display (supporting multiple languages).*
- **True RMS** Voltage, Current and Power monitoring.
- *Fully configurable inputs for use as alarms or a range of different functions.*

Using a PC and the Configuration Suite software allows alteration of selected operational sequences, timers and alarms.

A robust plastic case designed for front panel mounting houses the module. Connections are via locking plug and sockets.

 **CAUTION! Care must be taken when designing the breaker control circuit. It is essential that the tie breaker opens should DC supply to the DSE8680 be lost.**

3 SPECIFICATIONS

3.1 PART NUMBERING

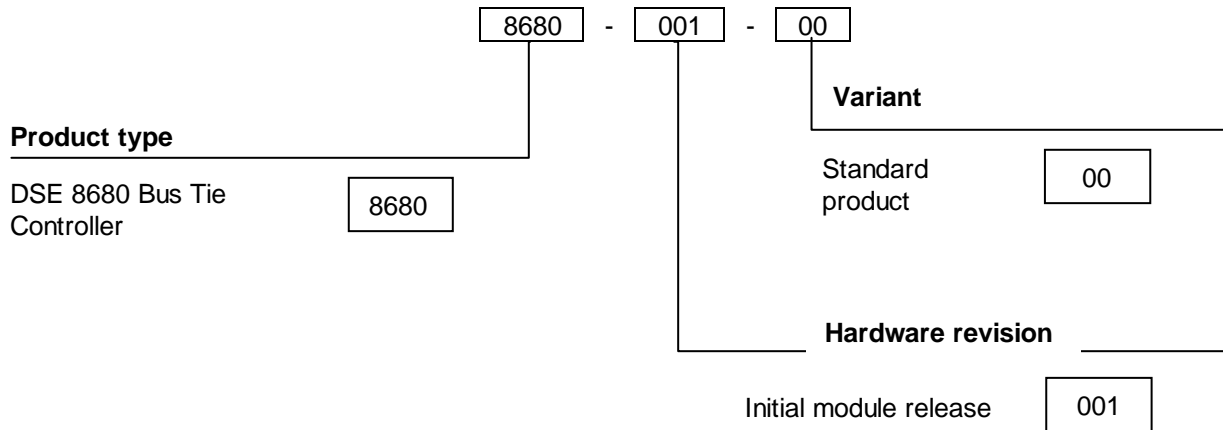

At the time of this document production, there are no variants of this product.

3.1.1 SHORT NAMES

Short name	Description
DSE8600, DSE86xx	All modules in the DSE8600 Series

3.2 TERMINAL SPECIFICATION

Connection type	Two part connector. <ul style="list-style-type: none"> • Male part fitted to module • Female part supplied in module packing case - Screw terminal, rising clamp, no internal spring. 	 <p>Example showing cable entry and screw terminals of a 10 way connector</p>
Minimum cable size	0.5 mm ² (AWG 24)	
Maximum cable size	2.5 mm ² (AWG 10)	

NOTE: For purchasing additional connector plugs from DSE, please see the section entitled *Maintenance, Spares, Repair and Servicing* elsewhere in this document.

3.3 POWER SUPPLY REQUIREMENTS

Minimum supply voltage	8 V continuous
Cranking dropouts	Able to survive 0 V for 50 mS providing the supply was at least 10 V before the dropout and recovers to 5 V afterwards. This is more than sufficient to allow the module to operate during engine cranking where the battery supply falls as low as 4 V (on a 12 V system!) This is achieved without the need for internal batteries or other external requirements.
Maximum supply voltage	35 V continuous (60 V protection for surges)
Reverse polarity protection	-35 V continuous
Maximum operating current (all inputs and outputs on)	400 mA at 24 V 200 mA at 12 V
Maximum standby current (all inputs and outputs off)	110 mA at 24 V 210 mA at 12 V

Plant supply instrumentation display

Range	0 V-70 V DC (Note Maximum continuous operating voltage of 35 V DC)
Resolution	0.1 V
Accuracy	±1 % full scale (± 0.7V)

3.4 BUS 1 AND BUS 2 VOLTAGE / FREQUENCY SENSING

Measurement type	True RMS conversion
Sample Rate	5 kHz or better
Harmonics	Up to 10 th or better
Input Impedance	300 KΩ ph-N
Phase to Neutral	15 V (minimum required for sensing frequency) to 333 V AC (absolute maximum) Suitable for 110 V to 277 V nominal (±20 % for under/overvoltage detection)
Phase to Phase	26 V (minimum required for sensing frequency) to 576 V AC (absolute maximum) Suitable for 190 V ph-ph to 479 V ph-ph nominal (±20 % for under/overvoltage detection)
Common mode offset from Earth	100 V AC (max)
Resolution	1 V AC phase to neutral 2 V AC phase to phase
Accuracy	±1 % of full scale phase to neutral (±3.33 V ph-N) ±2 % of full scale phase to phase (±11.52 V ph-ph)
Minimum frequency	3.5 Hz
Maximum frequency	75.0 Hz

Specifications

Frequency resolution	0.1 Hz
Frequency accuracy	± 0.2 Hz

3.5 INPUTS

3.5.1 DIGITAL INPUTS

Number	11
Arrangement	Contact between terminal and ground
Low level threshold	2.1 V minimum
High level threshold	6.6 V maximum
Maximum input voltage	+50 V DC with respect to plant supply negative
Minimum input voltage	-24 V DC with respect to plant supply negative
Contact wetting current	7 mA typical
Open circuit voltage	12 V typical

3.6 OUTPUTS

3.6.1 OUTPUTS A & B

Outputs A & B are not fitted to the DSE8680 controller.

3.6.2 OUTPUTS C & D

Type	Voltage free relays, fully configurable, normally used for bus load switch control.
Rating	8 A resistive @ 250 V AC

⚠ CAUTION! Care must be taken when designing the breaker control circuit. It is essential that the tie breaker opens should DC supply to the DSE8680 be lost.

3.6.3 OUTPUTS E,F,G,H,I & J

Type	Fully configurable, supplied from DC supply terminal 2.
Rating	3 A resistive @ 35 V

3.7 COMMUNICATION PORTS

USB Port	USB2.0 Device for connection to PC running DSE configuration suite only Max distance 6 m (20 feet)
Serial Communication	RS232 and RS485 are both fitted for individual or simultaneous operation.
RS232 Serial port	Non – Isolated port Max Baud rate 115200 baud subject to S/W TX, RX, RTS, CTS, DSR, DTR, DCD Male 9 way D type connector Max distance 15 m (50 feet)
RS485 Serial port	Isolated Data connection 2 wire + common Half Duplex Data direction control for Transmit (by s/w protocol) Max Baud Rate 115200 External termination required (120 Ω) Max common mode offset 70V (on board protection transorb) Max distance 1.2 km (¾ mile)
MSC Ports (2)	MSC Port for connection to DSE8610 and DSE8710 controllers

Specifications

	Max distance 240 m (133 feet). Use DSE124 to extend this if required.
--	--

3.7.1.2 RS232

The RS232 port on the DSE8600 series controller supports the Modbus RTU protocol. The Gencomm register table for the controller is available upon request from the DSE Technical Support Department.

RS232 is for short distance communication (max 15 m) and is typically used to connect the DSE86xx series controller to a telephone or GSM modem for more remote communications.

Many PCs are not fitted with an internal RS232 serial port. DSE DOES NOT recommends the use of USB to RS232 converters but can recommend PC add-ons to provide the computer with an RS232 port.

Recommended PC Serial Port add-ons (for computers without internal RS232 port):
Remember to check these parts are suitable for your PC. Consult your PC supplier for further advice.

- Brainboxes PM143 PCMCIA RS232 card (for laptop PCs)
- Brainboxes VX-001 Express Card RS232 (for laptops and nettops PCs)
- Brainboxes UC246 PCI RS232 card (for desktop PCs)
- Brainboxes PX-246 PCI Express 1 Port RS232 1 x 9 Pin (for desktop PCs)



Supplier:

Brainboxes

Tel: +44 (0)151 220 2500

Web: <http://www.brainboxes.com>

Email: Sales:sales@brainboxes.com

NB DSE Have no business tie to Brainboxes. Over many years, our own engineers have used these products and are happy to recommend them.

Specifications

RECOMMENDED EXTERNAL MODEMS:

- Multitech Global Modem – MultiModem ZBA (PSTN)
DSE Part Number 020-252
(Contact DSE Sales for details of localisation kits for these modems)



- Wavecom Fastrak Supreme GSM modem kit (PSU, Antenna and modem)*
DSE Part number 0830-001-01



- Brodersen GSM Industrial Modem*
DSE Part number 020-245



NOTE: *For GSM modems, a SIM card is required, supplied by your GSM network provider:

- For SMS only, a 'normal' voice SIM card is required. This enables the controller to send SMS messages to designated mobile phones upon status and alarm conditions.
- For a data connection to a PC running DSE Configuration Suite Software, a 'special' CSD (Circuit Switched Data) SIM card is required that will enable the modem to answer an incoming data call. Many 'pay as you go' services will not provide a CSD (Circuit Switched Data) SIM card.

3.7.1.3 RS485

The RS485 port on the DSE8600 series controller supports the Modbus RTU protocol.

The DSE Gencomm register table for the controller is available upon request from the DSE Technical Support Department.

RS485 is used for point-to-point cable connection of more than one device (maximum 32 devices) and allows for connection to PCs, PLCs and Building Management Systems (to name just a few devices).

One advantage of the RS485 interface is the large distance specification (1.2 km when using Belden 9841 (or equivalent) cable). This allows for a large distance between the DSE8600 series module and a PC running the DSE Configuration Suite software. The operator is then able to control the module, starting or stopping the generator(s), selecting operating modes, etc.

The various operating parameters (such as output voltage, oil pressure, etc.) of the remote generator(s) can be viewed or changed.

NOTE: - For a single module to PC connection and distances up to 6 m (8 yds), the USB connection method is more suitable and provides for a lower cost alternative to RS485 (which is more suited to longer distance connections).

Recommended PC Serial Port add-ons (for computers without internal RS485 port).

Remember to check these parts are suitable for your PC. Consult your PC supplier for further advice.

- Brainboxes PM154 PCMCIA RS485 card (for laptops PCs)
Set to 'Half Duplex, Autogating" with 'CTS True' set to 'enabled'
- Brainboxes VX-023 ExpressCard 1 Port RS422/485 (for laptops and nettop PCs)
- Brainboxes UC320 PCI Velocity RS485 card (for desktop PCs)
Set to 'Half Duplex, Autogating" with 'CTS True' set to 'enabled'
- Brainboxes PX-324 PCI Express 1 Port RS422/485 (for desktop PCs)



Supplier:

Brainboxes

Tel: +44 (0)151 220 2500

Web: <http://www.brainboxes.com>

Email: Sales: sales@brainboxes.com

NB DSE Have no business tie to Brainboxes. Over many years, our own engineers have used these products and are happy to recommend them.

3.7.1.4 ETHERNET

Ethernet is not currently available on the DSE8680 controller but will be made available by a future firmware update.

3.8 DSENET® FOR EXPANSION MODULES

DSENet® is the interconnection cable between the host controller and the expansion module(s) and must not be connect to any device other than DSE equipment designed for connection to the DSENet®

Cable type	Two core screened twisted pair
Cable characteristic impedance	120 Ω
Recommended cable	Belden 9841 Belden 9271
Maximum cable length	1200 m (¾ mile) when using Belden 9841 or direct equivalent. 600 m (666 yds) when using Belden 9271 or direct equivalent.
DSENet® topology	“Daisy Chain” Bus with no stubs (spurs)
DSENet® termination	120 Ω. Fitted internally to host controller. Must be fitted externally to the ‘last’ expansion module by the customer.

▲ NOTE: As a termination resistor is internally fitted to the host controller, the host controller must be the ‘first’ unit on the DSENet®. A termination resistor **MUST** be fitted to the ‘last’ unit on the DSENet®. For connection details, you are referred to the section entitled ‘typical wiring diagram’ elsewhere in this document.

▲ NOTE: DSE8680 series do not support the 2510/2520 display modules.

3.9 SOUNDER

DSE8600 Series features an internal sounder to draw attention to warning, shutdown and electrical trip alarms.

Sounder level	64 db @ 1 m
---------------	-------------

3.9.1 ADDING AN EXTERNAL SOUNDER TO THE APPLICATION

Should an external alarm or indicator be required, this can be achieved by using the DSE Configuration Suite PC software to configure an auxiliary output for *Audible Alarm*, and by configuring an auxiliary input for *Alarm Mute* (if required).

The audible alarm output activates and de-activates at the same time as the module's internal sounder. The Alarm mute input and internal alarm mute button activate 'in parallel' with each other. Either signal will mute both the internal sounder and audible alarm output.

Example of configuration to achieve external sounder with external alarm mute button:

The screenshot shows two configuration panels from the DSE Configuration Suite PC software. The first panel, titled "Relay Outputs (DC Supply Out)", has a table with two columns: "Source" and "Polarity". Under "Source", "Output E" is set to "Audible Alarm". Under "Polarity", "Output E" is set to "Energise". The second panel, titled "Digital Input A", has a "Function" dropdown menu set to "Alarm Mute".

Output	Source	Polarity
Output E	Audible Alarm	Energise

Function
Alarm Mute

3.10 DIMENSIONS AND MOUNTING

3.10.1.1 DIMENSIONS

240.0 mm x 181.1 mm x 41.7 mm (9.4" x 7.1" x 1.6")

PANEL CUTOUT

220 mm x 160 mm (8.7" x 6.3")

WEIGHT

0.7 kg (1.4 lb)

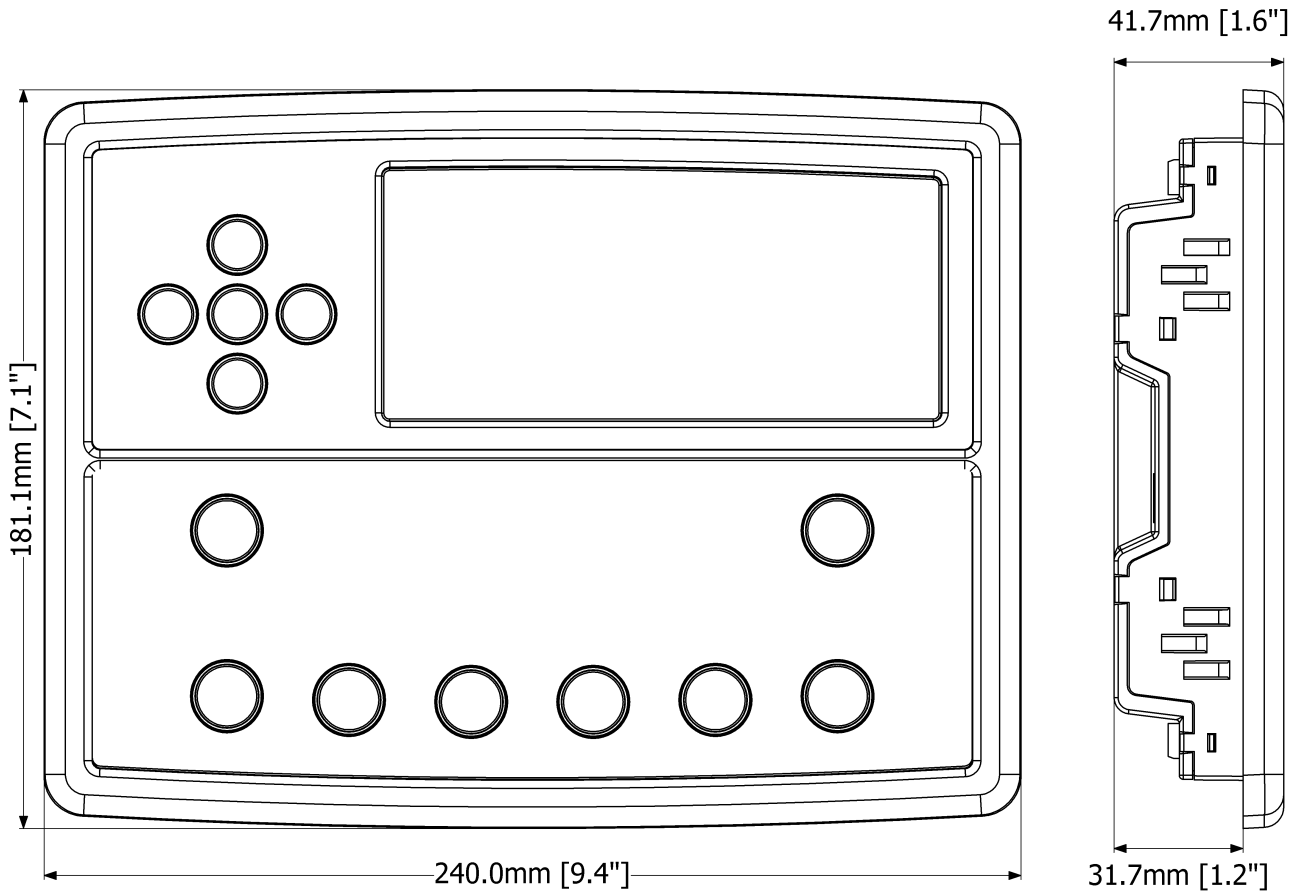

FIXING CLIPS

Supplied fixing clips hold the module into the panel fascia.

Withdraw the fixing clip screw (turn anticlockwise) until only the pointed end is protruding from the clip.

- Insert the three 'prongs' of the fixing clip into the slots in the side of the 8680 series module case.
- Pull the fixing clip backwards (towards the back of the module) ensuring all three prongs of the clip are inside their allotted slots.
- Turn the fixing clip screws clockwise until they make contact with the panel fascia.
- Turn the screws a little more to secure the module into the panel fascia. Take care not to over tighten the fixing clip screws.

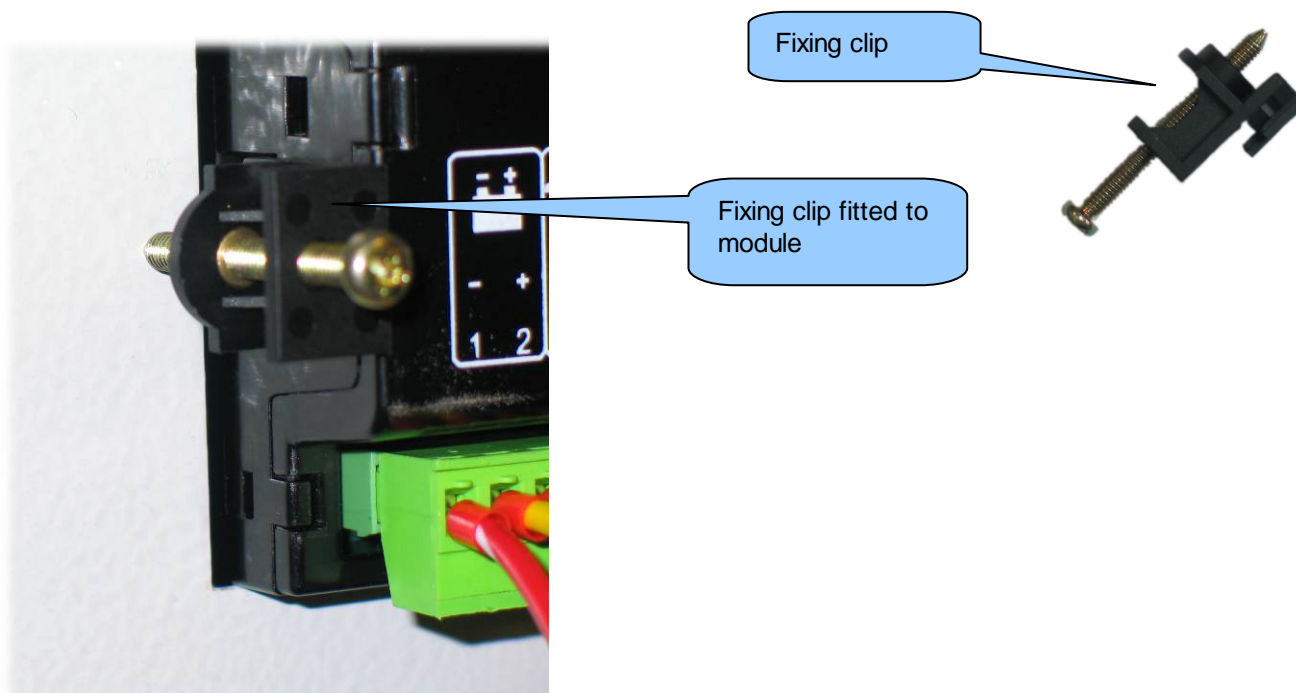

NOTE:- In conditions of excessive vibration, mount the module on suitable anti-vibration mountings.

3.10.2 CABLE TIE FIXING POINTS

Integral cable tie fixing points are included on the rear of the module's case to aid wiring. This additionally provides strain relief to the cable loom by removing the weight of the loom from the screw connectors, thus reducing the chance of future connection failures.

Care should be taken not to over tighten the cable tie (for instance with cable tie tools) to prevent the risk of damage to the module case.



Cable tie fixing point

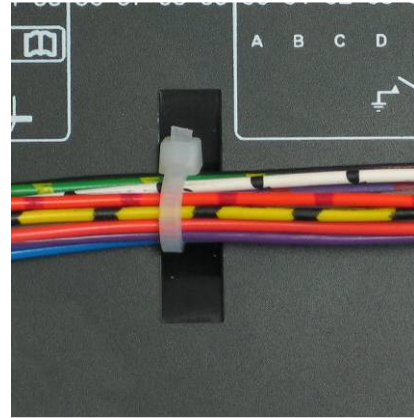

With cable and tie in place

3.10.3 SILICON SEALING GASKET

The supplied silicon gasket provides improved sealing between the 8680 series module and the panel fascia. The gasket is fitted to the module before installation into the panel fascia.

Take care to ensure the gasket is correctly fitted to the module to maintain the integrity of the seal.

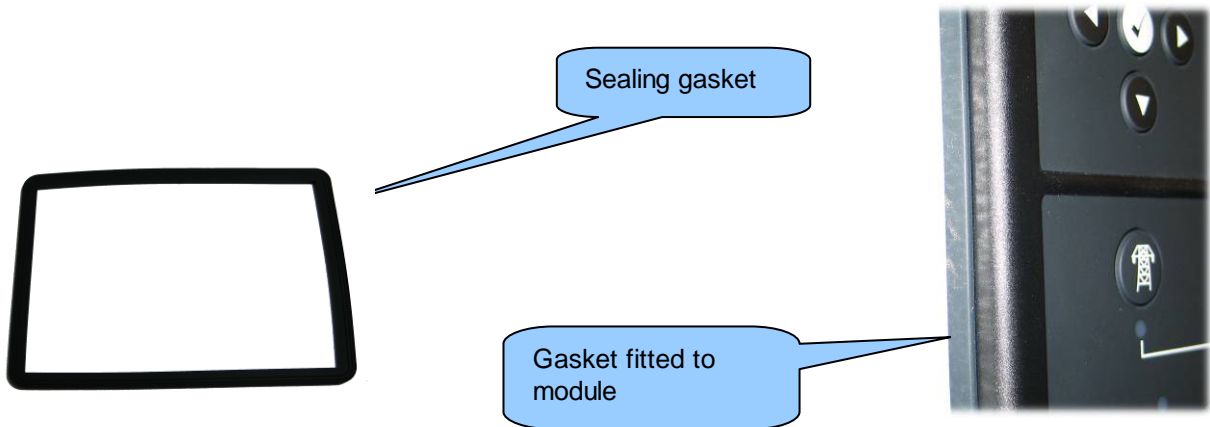

3.11 APPLICABLE STANDARDS

ISO 31-1	Using physical quantities, quantity and unit symbols and The International System of Units (abbreviated SI from the French <i>Le Système International d'Unités</i>)
BS 4884-1	This document conforms to BS4884-1 1992 Specification for presentation of essential information.
BS 4884-2	This document conforms to BS4884-2 1993 Guide to content
BS 4884-3	This document conforms to BS4884-3 1993 Guide to presentation
BS EN 60068-2-1 (Minimum temperature)	-30 °C (-22 °F)
BS EN 60068-2-2 (Maximum temperature)	+70 °C (158 °F)
BS EN 60950	Safety of information technology equipment, including electrical business equipment
BS EN 61000-6-2	EMC Generic Immunity Standard (Industrial)
BS EN 61000-6-4	EMC Generic Emission Standard (Industrial)
BS EN 60529 (Degrees of protection provided by enclosures) (see overleaf)	IP65 (front of module when installed into the control panel with the supplied sealing gasket) IP42 (front of module when installed into the control panel WITHOUT being sealed to the panel)
UL508 NEMA rating (Approximate) (see overleaf)	12 (Front of module when installed into the control panel with the supplied sealing gasket). 2 (Front of module when installed into the control panel WITHOUT being sealed to the panel)
IEEE C37.2 (Standard Electrical Power System Device Function Numbers and Contact Designations)	Under the scope of IEEE 37.2, <i>function numbers can also be used to represent functions in microprocessor devices and software programs.</i> The 8680 series controller is device number 11L-8680 (Multifunction device protecting Line (mains) – 8680 series module). As the module is configurable by the generator OEM, the functions covered by the module will vary. Under the module's factory configuration, the device numbers included within the module are : 27AC – AC undervoltage relay 27DC – DC undervoltage relay 30 – annunciator relay 42 – Running circuit breaker 52 – AC circuit breaker 59AC – AC overvoltage relay 59DC – DC overvoltage relay 74– Alarm relay 81 – Frequency relay 86 – Lockout relay

In line with our policy of continual development, Deep Sea Electronics, reserve the right to change specification without notice.

3.11.1 ENCLOSURE CLASSIFICATIONS

IP CLASSIFICATIONS

8600 series specification under BS EN 60529 Degrees of protection provided by enclosures

IP65 (Front of module when module is installed into the control panel with the optional sealing gasket).
IP42 (front of module when module is installed into the control panel WITHOUT being sealed to the panel)

First Digit	Second Digit
Protection against contact and ingress of solid objects	Protection against ingress of water
0 No protection	0 No protection
1 Protected against ingress solid objects with a diameter of more than 50 mm. No protection against deliberate access, e.g. with a hand, but large surfaces of the body are prevented from approach.	1 Protection against dripping water falling vertically. No harmful effect must be produced (vertically falling drops).
2 Protected against penetration by solid objects with a diameter of more than 12 mm. Fingers or similar objects prevented from approach.	2 Protection against dripping water falling vertically. There must be no harmful effect when the equipment (enclosure) is tilted at an angle up to 15° from its normal position (drops falling at an angle).
3 Protected against ingress of solid objects with a diameter of more than 2.5 mm. Tools, wires etc. with a thickness of more than 2.5 mm are prevented from approach.	3 Protection against water falling at any angle up to 60° from the vertical. There must be no harmful effect (spray water).
4 Protected against ingress of solid objects with a diameter of more than 1 mm. Tools, wires etc. with a thickness of more than 1 mm are prevented from approach.	4 Protection against water splashed against the equipment (enclosure) from any direction. There must be no harmful effect (splashing water).
5 Protected against harmful dust deposits. Ingress of dust is not totally prevented but the dust must not enter in sufficient quantity to interfere with satisfactory operation of the equipment. Complete protection against contact.	5 Protection against water projected from a nozzle against the equipment (enclosure) from any direction. There must be no harmful effect (water jet).
6 Protection against ingress of dust (dust tight). Complete protection against contact.	6 Protection against heavy seas or powerful water jets. Water must not enter the equipment (enclosure) in harmful quantities (splashing over).

Specifications

NEMA CLASSIFICATIONS

8600 series NEMA Rating (Approximate)

12 (Front of module when module is installed into the control panel with the optional sealing gasket).

2 (front of module when module is installed into the control panel WITHOUT being sealed to the panel)

 **NOTE: - There is no direct equivalence between IP / NEMA ratings. IP figures shown are approximate only.**



1 IP30	Provides a degree of protection against contact with the enclosure equipment and against a limited amount of falling dirt.
2 IP31	Provides a degree of protection against limited amounts of falling water and dirt.
3 IP64	Provides a degree of protection against windblown dust, rain and sleet; undamaged by the formation of ice on the enclosure.
3R IP32	Provides a degree of protection against rain and sleet;; undamaged by the formation of ice on the enclosure.
4 (X) IP66	Provides a degree of protection against splashing water, windblown dust and rain, hose directed water; undamaged by the formation of ice on the enclosure. (Resist corrosion).
12/12K IP65	Provides a degree of protection against dust, falling dirt and dripping non corrosive liquids.
13 IP65	Provides a degree of protection against dust and spraying of water, oil and non corrosive coolants.

4 INSTALLATION

The DSE8680 Series module is designed to be mounted on the panel fascia. For dimension and mounting details, see the section entitled *Specification, Dimension and mounting* elsewhere in this document.

4.1 TERMINAL DESCRIPTION

4.1.1 DC SUPPLY, FUEL AND START OUTPUTS

Icon	PIN No	DESCRIPTION	CABLE SIZE	NOTES
	1	DC Plant Supply Input (Negative)	2.5 mm ² AWG 13	
	2	DC Plant Supply Input (Positive)	2.5 mm ² AWG 13	(Recommended Maximum Fuse 15 A anti-surge) Supplies the module (2 A anti-surge requirement) and Output relays E,F,G & H
	3	Not Connected		
	4	Not Connected		
	5	Not Connected		
	6	Not Connected		
	7	Functional Earth	2.5 mm ² AWG 13	Connect to a good clean earth point.
	8	Output E	1.0 mm ² AWG 18	Plant Supply Positive from terminal 2. 3 A rated.
	9	Output F	1.0 mm ² AWG 18	Plant Supply Positive from terminal 2. 3 A rated.
	10	Output G	1.0 mm ² AWG 18	Plant Supply Positive. from terminal 2. 3 A rated.
	11	Output H	1.0 mm ² AWG 18	Plant Supply Positive from terminal 2. 3 A rated.
	12	Output I	1.0 mm ² AWG 18	Plant Supply Positive from terminal 2. 3 A rated.
	13	Output J	1.0 mm ² AWG 18	Plant Supply Positive from terminal 2. 3 A rated.



 **NOTE:-** Terminals 14-21 are not fitted to the DSE8680 series controller.

4.1.2 MAGNETIC PICKUP, CAN AND EXPANSION

	PIN No	DESCRIPTION	CABLE SIZE	NOTES
MSC1	25	BUS 1 MultiSet Comms (MSC) Link H	0.5 mm ² AWG 20	Use only 120 Ω RS485 approved cable
	26	BUS 1 MultiSet Comms (MSC) Link L	0.5 mm ² AWG 20	Use only 120 Ω RS485 approved cable
	27	BUS 1 MultiSet Comms (MSC) Link SCR	0.5 mm ² AWG 20	Use only 120 Ω RS485 approved cable
	28	DSENet expansion +	0.5 mm ² AWG 20	Use only 120 Ω RS485 approved cable
	29	DSENet expansion -	0.5 mm ² AWG 20	Use only 120 Ω RS485 approved cable
	30	DSENet expansion SCR	0.5 mm ² AWG 20	Use only 120 Ω RS485 approved cable
MSC2	31	BUS 2 MultiSet Comms (MSC) Link H	0.5 mm ² AWG 20	Use only 120 Ω RS485 approved cable
	32	BUS 2 MultiSet Comms (MSC) Link L	0.5 mm ² AWG 20	Use only 120 Ω RS485 approved cable
	33	BUS 2 MultiSet Comms (MSC) Link SCR	0.5 mm ² AWG 20	Use only 120 Ω RS485 approved cable
	34	Not Connected		
	35	Not Connected		
	36	Not Connected		
	37	Not Connected		
	38	Not Connected		

 **NOTE:-** Screened 120Ω impedance cable specified for use with CAN must be used for the DSENet link and the Multiset comms (MSC) link.
DSE stock and supply Belden cable 9841 which is a high quality 120 Ω impedance cable suitable for CAN use (DSE part number 016-030)

4.1.3 LOAD SWITCHING AND BUS 1 SENSING (V1)

	PIN No	DESCRIPTION	CABLE SIZE	NOTES
	39	Output relay C	1.0 mm AWG 18	Normally configured to control load switching device (Recommend 10 A fuse)
	40	Output relay C	1.0 mm AWG 18	Normally configured to control load switching device
	41	Output relay D	1.0 mm AWG 18	Normally configured to control load switching device (Recommend 10 A fuse)
	42	Output relay D	1.0 mm AWG 18	Normally configured to control load switching device
V1	43	BUS 1 L1 (R) voltage monitoring	1.0 mm AWG 18	Connect to LEFT BUS L1 (R) incoming supply (AC) (Recommend 2 A fuse)
	44	BUS 1 L2 (S) voltage monitoring	1.0 mm AWG 18	Connect to LEFT BUS L1 (S) incoming supply (AC) (Recommend 2 A fuse)
	45	BUS 1 L3 (T) voltage monitoring	1.0 mm AWG 18	Connect to LEFT BUS L1 (T) incoming supply (AC) (Recommend 2 A fuse)
	46	BUS 1 Neutral (N) input	1.0 mm AWG 18	Connect to Mains N incoming supply (AC)

 **NOTE:** - The above table describes connections to a three phase, four-wire system. For alternative wiring topologies, please see the **ALTERNATIVE AC TOPOLOGIES** section of this manual.

 **CAUTION!** Care must be taken when designing the breaker control circuit. It is essential that the tie breaker opens should DC supply to the DSE8680 be lost.

4.1.4 BUS 2 SENSING (V2)

	PIN No	DESCRIPTION	CABLE SIZE	NOTES
V2	47	BUS 2 L1 (U) voltage monitoring	1.0 mm AWG 18	Connect to LEFT BUS L1 (U) incoming supply (AC) (Recommend 2 A fuse)
	48	BUS 2 L2 (V) voltage monitoring	1.0 mm AWG 18	Connect to LEFT BUS L1 (V) incoming supply (AC) (Recommend 2 A fuse)
	49	BUS 2 L3 (W) voltage monitoring	1.0 mm AWG 18	Connect to LEFT BUS L1 (W) incoming supply (AC) (Recommend 2 A fuse)
	50	BUS 2 Neutral (N) input	1.0 mm AWG 18	Connect to Mains N incoming supply (AC)

 **NOTE:-** The above table describes connections to a three phase, four wire system. For alternative wiring topologies, please see the **ALTERNATIVE AC TOPOLOGIES** section of this manual.



 **NOTE:-** Terminals 51-59 are not fitted to the DSE8680 series controller.

4.1.5 CONFIGURABLE DIGITAL INPUTS

	PIN No	DESCRIPTION	CABLE SIZE	NOTES
	60	Configurable digital input A	0.5 mm ² AWG 20	Switch to negative
	61	Configurable digital input B	0.5 mm ² AWG 20	Switch to negative
	62	Configurable digital input C	0.5 mm ² AWG 20	Switch to negative
	63	Configurable digital input D	0.5 mm ² AWG 20	Switch to negative
	64	Configurable digital input E	0.5 mm ² AWG 20	Switch to negative
	65	Configurable digital input F	0.5 mm ² AWG 20	Switch to negative
	66	Configurable digital input G	0.5 mm ² AWG 20	Switch to negative
	67	Configurable digital input H	0.5 mm ² AWG 20	Switch to negative
	68	Configurable digital input I	0.5 mm ² AWG 20	Switch to negative
	69	Configurable digital input J	0.5 mm ² AWG 20	Switch to negative
	70	Configurable digital input K	0.5 mm ² AWG 20	Switch to negative

4.1.6 PC CONFIGURATION INTERFACE CONNECTOR

This configuration cable is the same as normally used between a PC and a USB printer!

	DESCRIPTION	CABLE SIZE	NOTES
 	Socket for connection to PC with 86xx series PC software.	0.5 mm ² AWG 20	This is a standard USB type A to type B connector. 

NOTE: - The USB connection cable between the PC and the DSE8680 series module must not extend beyond 5 m (5 yds). For distances over 5m, it is possible to use a third party USB extender. Typically, they extend USB up to 50 m (yds). The supply and support of this type of equipment is outside the scope of Deep Sea Electronics PLC.

CAUTION! Care must be taken not to overload the PC's USB system by connecting more than the recommended number of USB devices to the PC. For further information, consult your PC supplier.

CAUTION! This socket must not be used for any other purpose.

4.1.7 RS485 CONNECTOR

PIN No	NOTES
A	Two core screened twisted pair cable. 120 Ω impedance suitable for RS485 use.
B	Recommended cable type - Belden 9841
SCR	Max distance 1200 m (1.2 km) when using Belden 9841 or direct equivalent.

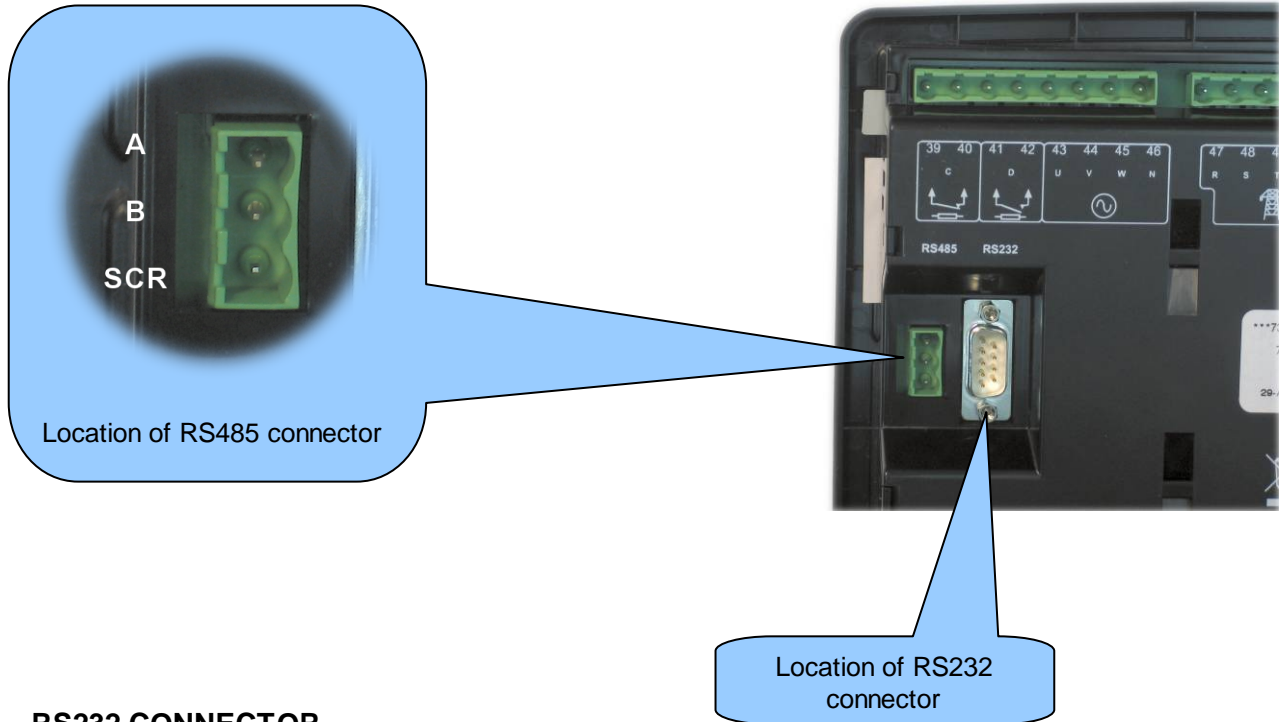

4.1.8 RS232 CONNECTOR

PIN No	NOTES
1	Received Line Signal Detector (Data Carrier Detect)
2	Received Data
3	Transmit Data
4	Data Terminal Ready
5	Signal Ground
6	Data Set Ready
7	Request To Send
8	Clear To Send
9	Ring Indicator

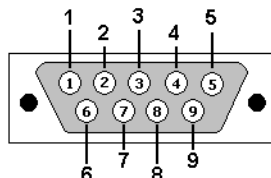

View looking into the male connector on the 8680 series module

4.2 TYPICAL WIRING DIAGRAMS

As every system has different requirements, these diagrams show only a TYPICAL system and do not intend to show a complete system.

Genset manufacturers and panel builders may use these diagrams as a starting point; however, you are referred to the completed system diagram provided by your system manufacturer for complete wiring detail.

Further wiring suggestions are available in the following DSE publications, available at www.deepseapl.com to website members.

DSE PART	DESCRIPTION
056-022	Breaker Control (Training guide)

Maintenance, Spares, Repair and Servicing

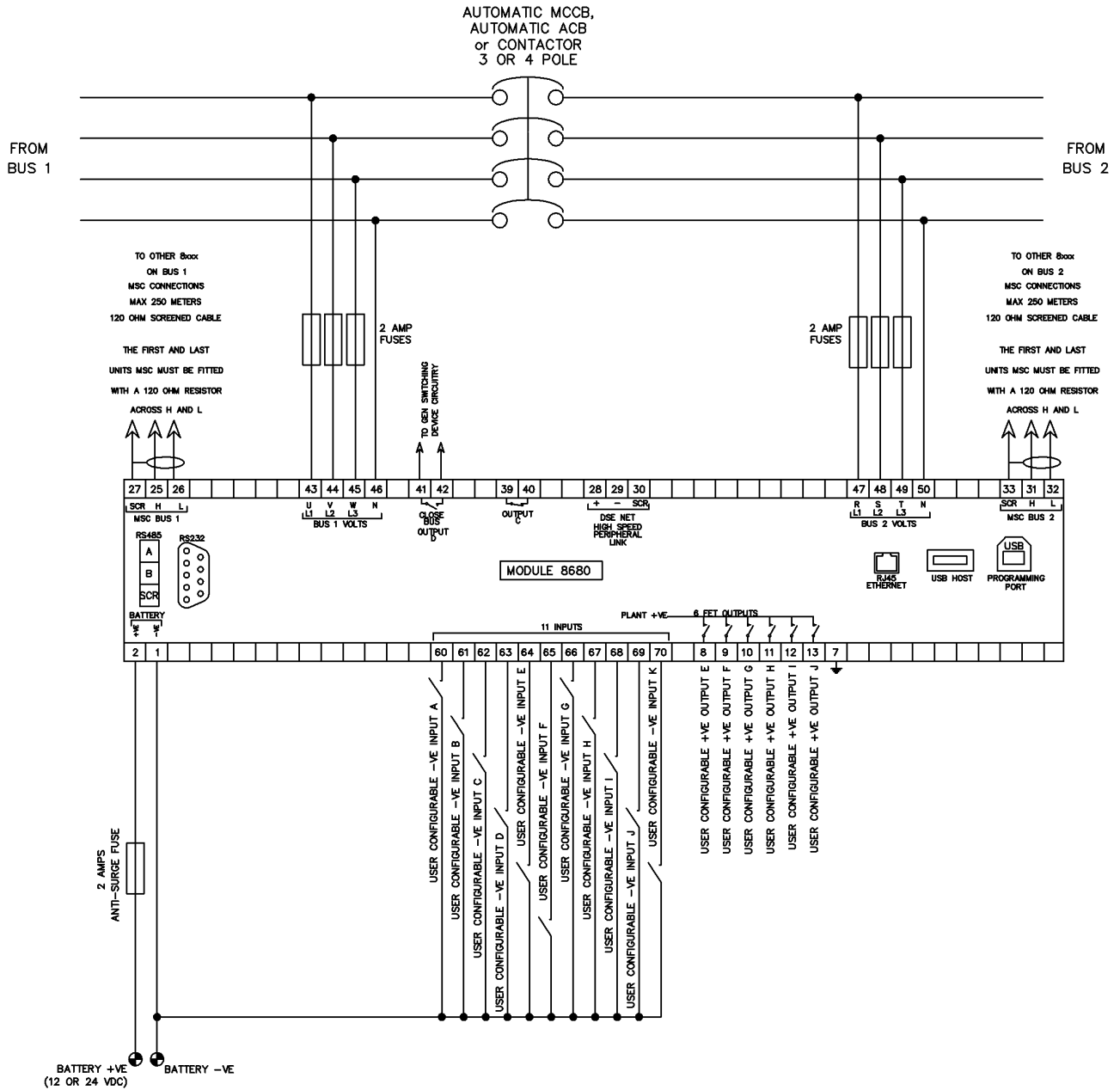

NOTE: One of the *user configurable* digital inputs must be used to monitor the state of the bus tie breaker. Configure the input to *Bus Tie Closed Auxiliary* using the DSE Config Suite Software.

CAUTION! Care must be taken when designing the breaker control circuit. It is essential that the tie breaker opens should DC supply to the DSE8680 be lost.

4.2.1 DSENET®

DSENet® is the communication port between the host controller (DSE86xx series) and the expansion device as shown below. Further details are contained within the *Specification* section of this document and within the operator manual for the specific expansion module you are connecting to.

NOTE: - Screened 120 Ω impedance cable specified for use with CAN must be used for the DSENet® (RS485) connection.

DSE stock and supply Belden cable 9841 which is a high quality 120 Ω impedance cable suitable for DSENet® use (DSE part number 016-030)

A maximum of twenty (20) devices can be connected to the DSENet®, made up of the following devices :

Device	Max number supported
DSE2130 Input Expansion	4
DSE2157 Output Expansion	10
DSE2548 LED Expansion	10

NOTE : DSE8600 series does not support the 2510/2520 display modules.

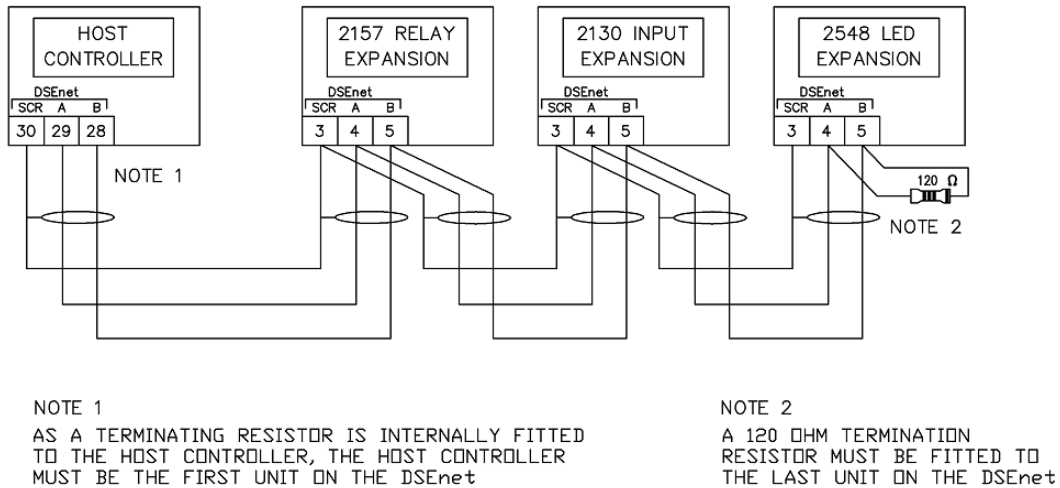

5 DESCRIPTION OF CONTROLS

The following section details the function and meaning of the various controls on the module.

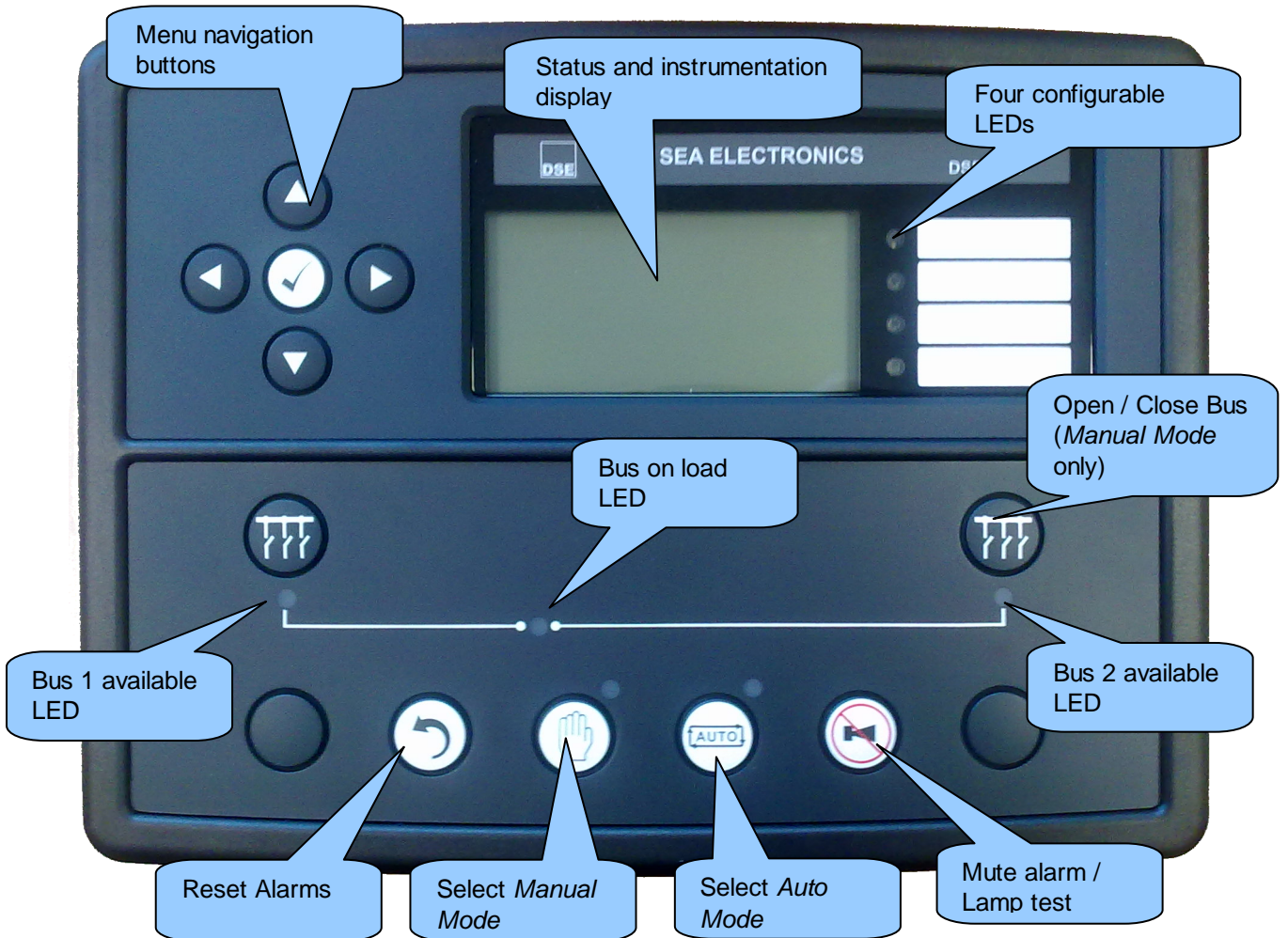

5.1 VIEWING THE INSTRUMENT PAGES

It is possible to scroll to display the different pages of information by repeatedly operating the next / previous page buttons



Example



If you want to view one of the instrument pages towards the end of the list, it may be quicker to scroll left through the pages rather than right!

And so on until the last page is reached.

A Further press of the scroll right button returns the display to the Status page.

The complete order and contents of each information page are given in the following sections

Once selected the page will remain on the LCD display until the user selects a different page, or after an extended period of inactivity (*LCD Page Timer*), the module will revert to the status display.

If no buttons are pressed upon entering an instrumentation page, the instruments are displayed automatically subject to the setting of the *LCD Scroll Timer*.

The *LCD Page* and *LCD Scroll* timers are configurable using the DSE Configuration Suite Software or by using the Front Panel Editor.

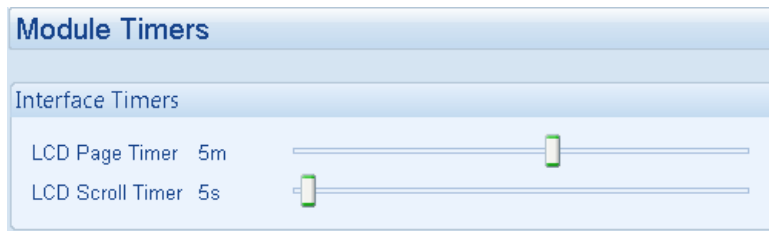

The screenshot shows the factory settings for the timers, taken from the DSE Configuration Suite Software.

Alternatively, to scroll manually through all instruments on the currently selected page, press the scroll buttons. The 'autoscroll' is disabled.



If you want to view one of the instruments towards the end of the list, it may be quicker to scroll up through the instruments rather than down!

To re-enable 'autoscroll' press the scroll buttons to scroll to the 'title' of the instrumentation page (i.e. Engine). A short time later (the duration of the *LCD Scroll Timer*), the instrumentation display will begin to autoscroll.

When scrolling manually, the display will automatically return to the Status page if no buttons are pressed for the duration of the configurable *LCD Page Timer*.

If an alarm becomes active while viewing the status page, the display shows the Alarms page to draw the operator's attention to the alarm condition.

5.1.1 STATUS

This is the 'home' page, the page that is displayed when no other page has been selected, and the page that is automatically displayed after a period of inactivity (*LCD Page Timer*) of the module control buttons.

This page is configurable using the DSE Configuration Suite Software.

The contents of this display may vary depending upon configuration by the generator manufacturer / supplier.

The display above was achieved with the factory settings, shown below in the DSE Configuration suite software:

The screenshot shows a window titled "Configurable Status Screens" with a sub-section "Displayed Pages". It contains a table with 10 rows, each representing a page configuration. The first three pages are configured with specific data, while the remaining seven are set to "Not Used". A callout box points to the "Not Used" entries, stating: "Other pages can be configured to be shown, automatically scrolling."

Displayed Pages	
Page 1	Battery Voltage
Page 2	Bus 1 Frequency
Page 3	Bus 2 Frequency
Page 4	Not Used
Page 5	Not Used
Page 6	Not Used
Page 7	Not Used
Page 8	Not Used
Page 9	Not Used
Page 10	Not Used

NOTE:- The following sections detail instrumentation pages, accessible using the scroll left and right buttons, regardless of what pages are configured to be displayed on the 'status' screen.

5.1.2 BUS 1

Bus 1 voltage (L1-N, L2-N, L3-N)
 Bus 1 voltage (L1-L2, L2-L3, L3-L1)
 Bus Hz
 Bus 1 Phase Sequence
 Sets on Load (Bus 1, Bus 2)
 Battery voltage
 Synchroscope
 Bus commissioning screens

5.1.3 BUS 2

Bus 1 voltage (L1-N, L2-N, L3-N)
 Bus 1 voltage (L1-L2, L2-L3, L3-L1)
 Bus Hz
 Bus 1 Phase Sequence
 Sets on Load (Bus 1, Bus 2)
 Battery voltage
 Synchroscope
 Bus commissioning screens

5.1.4 SERIAL PORT

This section is included to give information about the currently selected serial port and external modem (if connected).

The items displayed on this page will change depending upon configuration of the module. You are referred to your system supplier for further details.

NOTE: - Factory Default settings are for the RS232 port to be enabled (no modem connected), operating at 19200 baud, modbus slave address 10.

Example 1 – Module connected to a RS232 telephone modem.

When the DSE86xx series module is power up, it will send 'initialisation strings' to the connected modem. It is important therefore that the modem is already powered, or is powered up at the same time as the DSE86xx series module. At regular intervals after power up, the modem is reset, and reinitialised, to ensure the modem does not 'hang up'.

If the DSE86xx series module does not correctly communicate with the modem, "Modem initialising" will appear on the Serial Port instrument screen as shown overleaf.

If the module is set for "incoming calls" or for "incoming and outgoing calls", then if the modem is dialled, it will answer after two rings (using the factory setting 'initialisation strings'. Once the call is established, all data is passed from the dialling PC and the DSE86xx series module.

If the module is set for "outgoing calls" or for "incoming and outgoing calls", then the module will dial out whenever an alarm is generated. Note that not all alarms will generate a dial out; this is dependant upon module configuration of the event log. Any item configured to appear in the event log will cause a dial out.

Serial Port	
Baud	9600
SlaveID	10
Modem	

Press down  to view the modem status....

Indicates that a modem is configured. Shows 'RS232' if no modem is configured or 'RS485' if the RS485 port is selected.

Example 1 continued – Modem diagnostics



Modem diagnostic screens are included; press  when viewing the *Serial Port* instrument to cycle the available screens. If you are experiencing modem communication problems, this information will aid troubleshooting.



Shows the state of the modem communication lines. These can help diagnose connection problems.

Example:

- RTS** A dark background shows the line is active.
- RTS** a grey background shows that the line is toggling high and low.
- RTS** No background indicates that the line is inactive

Line	Description	
RTS	Request To Send	Flow control
CTS	Clear To Send	Flow control
DSR	Data Set Ready	Ready to communicate
DTR	Data Terminal Ready	Ready to communicate
DCD	Data Carrier Detect	Modem is connected



Shows the last command sent to the modem and the result of the command.

Modem Setup Sequence

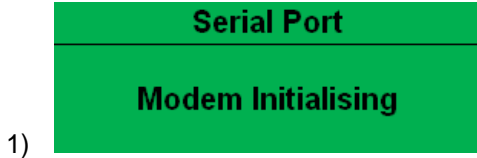

If the Modem and DSE8600 series communicate successfully:

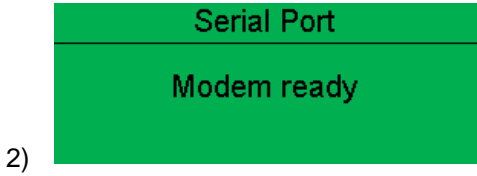

In case of communication failure between the modem and DSE8680 series module, the modem is automatically reset and initialisation is attempted once more:

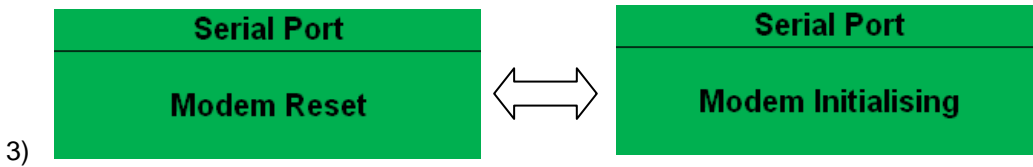

In the case of a module that is unable to communicate with the modem, the display will continuously cycle between 'Modem Reset' and 'Modem Initialising' as the module resets the modem and attempts to communicate with it again, this will continue until correct communication is established with the modem. In this instance, you should check connections and verify the modem operation.

Example 2 – Module connected to a modem.

Serial Port	
Baud	9600
SlaveID	10
Modem	

Example 3 – Modem status of a GSM modem

Currently connected GSM operator and signal strength.

Serial Port	
Signal	Orange
Modem Ready	

Many GSM modems are fitted with a status LED to show operator cell status and ringing indicator. These can be a useful troubleshooting tool.

In the case of GSM connection problems, try calling the DATA number of the SIMCARD with an ordinary telephone. There should be two rings, followed by the modem answering the call and then 'squealing'. If this does not happen, you should check all modem connections and double check with the SIM provider that it is a DATA SIM and can operate as a data modem. DATA is NOT the same as FAX or GPRS and is often called Circuit Switched Data (CSD) by the SIM provider.

NOTE: In the case of GSM modems, it is important that a DATA ENABLED SIM is used. This is often a different number than the 'voice number' and is often called Circuit Switched Data (CSD) by the SIM provider.

If the GSM modem is not purchased from DSE, ensure that it has been correctly set to operate at 9600 baud. You may need to install a terminal program on your PC and consult your modem supplier to do this. GSM modems purchased from DSE are already configured to work with the DSE8680 series module.

Example 4 - Module RS485 port configured for connection to a modbus master.

Serial Port	
Baud	19200
SlaveID	1
RS485	

DSE8680 series modules operate as a modbus RTU slave device.

In a modbus system, there can be only one Master, typically a PLC, HMI system or PC SCADA system.

This master requests for information from the modbus slave (DSE8680 series module) and may (in control systems) also send request to change operating modes etc. Unless the Master makes a request, the slave is 'quiet' on the data link.

The factory settings are for the module to communicate at 19200 baud, modbus slave address 10.

To use the RS485 port, ensure that 'port usage' is correctly set using the DSE Configuration Suite Software.

Required settings are shown below.

The screenshot shows the 'Serial Port Configuration' window with the following settings: Slave ID set to 10, Baud Rate set to 19200, and Port Usage set to RS485. Below this is the 'Connection Settings' window, which shows the Master inactivity timeout set to 5s, represented by a slider control.

'Master inactivity timeout' should be set to at least twice the value of the system scan time. For example if a modbus master PLC requests data from the DSE8680 modbus slave once per second, the timeout should be set to at least 2 seconds.

The DSE Modbus Gencomm document containing register mappings inside the DSE module is available upon request from support@deepseapl.com. Email your request along with the serial number of your DSE module to ensure the correct information is sent to you.

Typical requests (using Pseudo code)

BatteryVoltage=ReadRegister(10,0405,1) : reads register (hex) 0405 as a single register (battery voltage) from slave address 10.

WriteRegister(10,1008,2,35701, 65535-35701): Puts the module into AUTO mode by writing to (hex) register 1008, the values 35701 (auto mode) and register 1009 the value 65535-35701 (the bitwise opposite of auto mode)

Warning=(ReadRegister(10,0306,1) >> 11) & 1) : reads (hex) 0306 and looks at bit 12 (Warning alarm present)

ElectricalTrip=(ReadRegister(10,0306,1) >> 10) & 1) : reads (hex) 0306 and looks at bit 11 (Electrical Trip alarm present)

ControlMode=ReadRegister(10,0304,2); reads (hex) register 0304 (control mode).

5.1.5 ABOUT

Contains important information about the module and the firmware versions. This information may be asked for when contacting DSE Technical Support Department for advice.

- Module Type (i.e. 8610, 8680)
- Application Version – The version of the module's main firmware file – Updatable using the Firmware Update Wizard in the DSE Configuration Suite Software.
- USB ID – unique identifier for PC USB connection
- Analogue Measurements software version
- Firmware Update Boot loader software version

5.2 VIEWING THE EVENT LOG

The DSE8680 series modules maintain a log of past alarms and/or selected status changes. The log size has been increased in the module over past module updates and is always subject to change. At the time of writing, the DSE8680 log is capable of storing the last 250 entries.

Under default factory settings, the event log only includes shutdown and electrical trip alarms logged (The event log does not contain Warning alarms), however this is configurable by the system designer using the DSE Configuration Suite software.

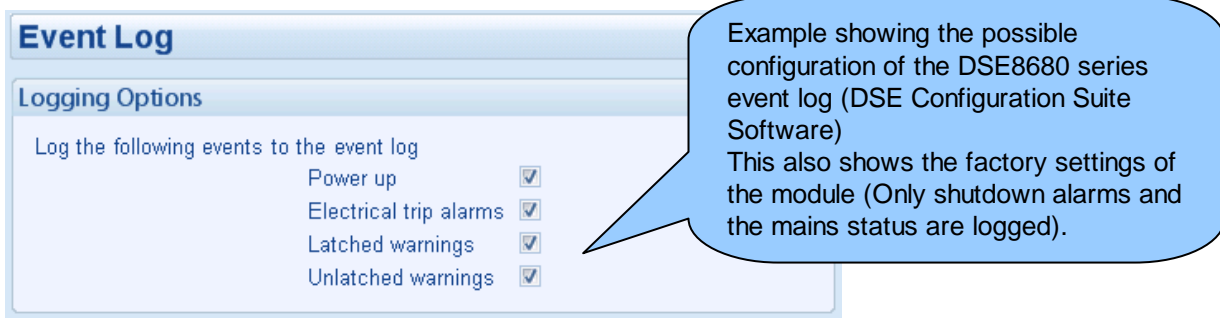

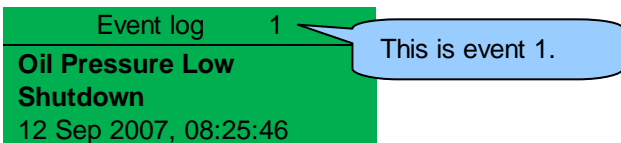

Once the log is full, any subsequent shutdown alarms will overwrite the oldest entry in the log. Hence, the log will always contain the most recent shutdown alarms. The module logs the alarm, along with the date and time of the event. If the module is configured and connected to send SMS text, a text of the event is sent also.

To view the event log, repeatedly press the next page button  until the LCD screen displays the Event log :



Press down  to view the next most recent shutdown alarm:

Continuing to press down  cycles through the past alarms after which the display shows the most recent alarm and the cycle begins again.

To exit the event log and return to viewing the instruments, press the next page  button to select the next instrumentation page.

5.3 USER CONFIGURABLE INDICATORS





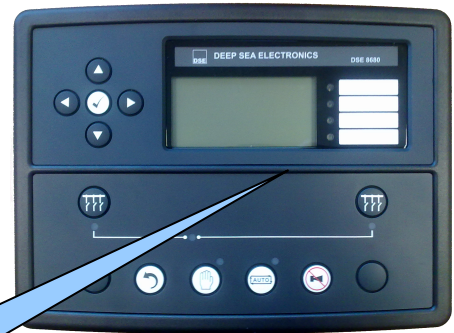

These LEDs can be configured by the user to indicate any one of **100+ different functions** based around the following:-

- **Indications** - Monitoring of a digital input and indicating associated functioning user's equipment - *Such as Battery Charger On or Louvres Open, etc.*
- **Alarms** - Specific indication of a particular warning or electrical trip condition, backed up by LCD indication
- **Status Indications** - Indication of specific functions or sequences derived from the modules operating state - *Such as, Panel Locked, Bus Available, etc*



User configurable LEDs

5.4 CONTROLS

<p>Reset Resets any alarms that have been detected by the controller.</p>	
<p>Manual This mode allows manual control of the functions. Once in Manual mode the module will respond to the  button, toggling the bus breaker. <i>For further details, please see the more detailed description of 'Manual operation' elsewhere in this manual.</i></p>	
<p>Auto This button places the module into its 'Automatic' mode. This mode allows the module to control the function of the system automatically. <i>For further details, please see the more detailed description of 'Auto operation' elsewhere in this manual.</i></p>	
<p>Mute / Lamp Test This button silences the audible alarm if it is sounding and illuminates all of the LEDs as a lamp test feature.</p>	
<p>Menu navigation Used for navigating the instrumentation, event log and configuration screens. For further details, please see the more detailed description of these items elsewhere in this manual.</p>	

6 OPERATION

The following description details the sequences followed by a module containing the standard 'factory configuration'.

Remember that if you have purchased a completed generator set or control panel from your supplier, the module's configuration will probably have been changed by them to suit their particular requirements.

Always refer to your configuration source for the exact sequences and timers observed by any particular module in the field.

6.1 AUTOMATIC MODE

NOTE: - If a digital input configured to *panel lock* is active, changing module modes will not be possible. Viewing the instruments and event logs is NOT affected by panel lock.

Activate auto mode by pressing the  pushbutton. An LED indicator beside the button confirms this action.

Auto mode will allow the DSE8680 to monitor the *open/close breaker* input and control the tie breaker accordingly.

The fascia mounted breaker control button  has no effect in AUTO mode.

If required, the two generator buses are synchronised before the tie breaker is closed. This operation is automatic, using the connection to the two MSC data links.

6.2 MANUAL MODE

NOTE:- If a digital input configured to *panel lock* is active, changing module modes will not be possible. Viewing the instruments and event logs is NOT affected by panel lock.

Activate Manual mode by pressing the  pushbutton. An LED indicator beside the button confirms this action.

Manual mode allows the operator to open and close the breaker manually by toggling the  button.

The *open/close breaker* digital input has no effect in MANUAL mode.

PROTECTIONS

When an alarm is present, the Audible Alarm will sound and the Common alarm LED if configured will illuminate.

The audible alarm can be silenced by pressing the *Mute button* 

The LCD display will jump from the 'Information page' to display the Alarm Page

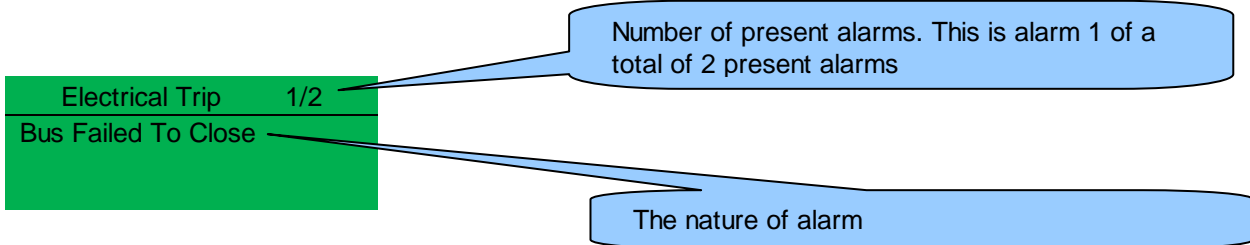

The LCD will display multiple alarms. These will automatically scroll in the order that they occurred.

6.3 INDICATIONS

Indications are non-critical and often status conditions. They do not appear on the LCD of the module as a text message. However, an output or LED indicator can be configured to draw the operator's attention to the event.

Example

- Input configured for indication.
- The LCD text will not appear on the module display but can be added in the configuration to remind the system designer what the input is used for.
- As the input is configured to *Indication* there is no alarm generated.
- LED Indicator to make LED1 illuminate when Digital Input A is active.
- The Insert Card Text allows the system designer to print an insert card detailing the LED function.
- Sample showing operation of the LED.

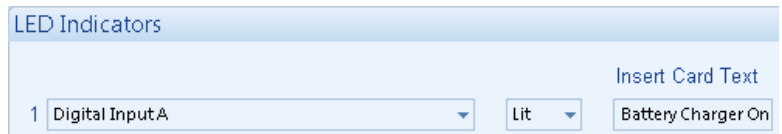
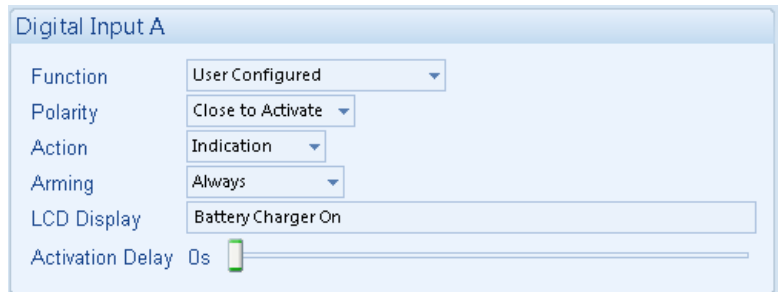

6.4 WARNINGS

Warnings are non-critical alarm conditions and do not affect the operation of the system, they serve to draw the operators attention to an undesirable condition.

In the event of an alarm the LCD will jump to the alarms page, and scroll through all active warnings and shutdowns.

By default, warning alarms are self-resetting when the fault condition is removed. However enabling 'all warnings are latched' will cause warning alarms to latch until reset manually. This is enabled using the 8600 series configuration suite in conjunction with a compatible PC.

Display	Reason
AUXILIARY INPUTS	Auxiliary inputs can be user configured and will display the message as written by the user.
BATTERY HIGH VOLTAGE	The DC supply has fallen below the low voltage setting level for the duration of the low battery voltage timer
BATTERY LOW VOLTAGE	The DC supply has risen above the high voltage setting level for the duration of the high battery voltage timer
FAILED TO OPEN	Contactors auxiliary input indicates the breaker has not opened when instructed to
FAILED TO SYNCHRONISE	Synchronisation has not been achieved within the time delay
MSC FAILURE	One or more modules seen previously on the MSC link are no longer communicating.
MSC ALARMS INHIBITED	The 'MSC Alarms Inhibit' input is active.
EXPANSION LINK LOST	The connection to one or more expansion units is not operating correctly.

6.5 ELECTRICAL TRIPS

Electrical trips are latching and stop the Generator but in a controlled manner. On initiation of the electrical trip condition the module will de-energise the 'Close Bus' Output to remove the load from the generator. Once this has occurred the start request is removed. The alarm must be accepted and cleared, and the fault removed to reset the module.

Electrical trips are latching alarms. Remove the fault then press RESET  to reset the module.

Display	Reason
AUXILIARY INPUTS	If an auxiliary input configured as an electrical trip is active, the appropriate message will be displayed as configured by the user.
BUS 1 PHASE ROTATION	Bus 1 phase rotation does not match the configuration
BUS 2 PHASE ROTATION	Bus 2 phase rotation does not match the configuration
BUS FAILED TO CLOSE	Contactors auxiliary input indicates the breaker has not closed when instructed to do so.
EXPANSION LINK LOST	The connection to one or more expansion units is not operating correctly.
MSC FAILURE	One or more modules seen previously on the MSC link are no longer communicating.
MSC COMPATABILITY	Incompatible modules detected on either MSC bus
OUT OF SYNC	Phase angle between buses is greater than the out of sync setting for the period of the out of sync timer.
UNIT NOT CONFIGURED	The module contains no valid configuration. Use Configuration Suite to reconfigure the module. Contact DSE support if the problem persists.

6.6 FRONT PANEL CONFIGURATION

This configuration mode allows the operator limited customising of the way the module operates.

Use the module's navigation buttons to traverse the menu and make value changes to the parameters:

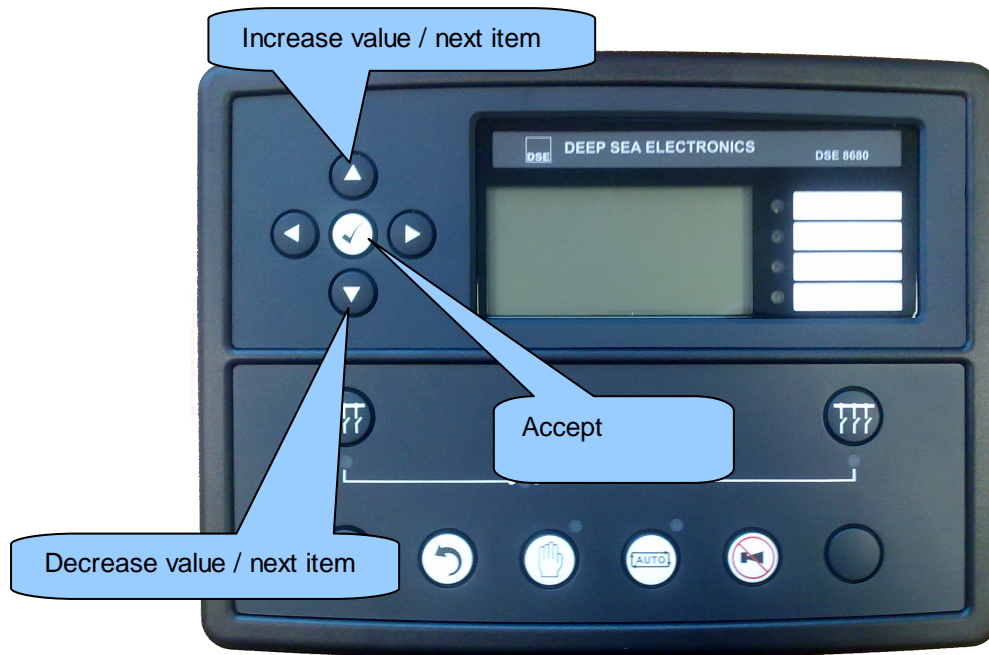

6.7 ACCESSING THE 'RUNNING' CONFIGURATION EDITOR

The 'running' editor can be entered at any time. All protections remain active.

Press and hold the  button to enter the running editor.

6.7.1 EDITING A PARAMETER

Enter the editor as described above.





Press the  (up or down) buttons to select the parameter you wish to view/change within the currently selected section.

To edit the parameter, press  to enter edit mode. The parameter begins to flash to indicate that you are editing the value.



Press the  (up or down) buttons to change the parameter to the required value.

Press  to save the value. The parameter ceases flashing to indicate that it has been saved.

To exit the editor at any time, press and hold the  button.

6.7.2 ADJUSTABLE PARAMETERS (RUNNING EDITOR)

Running Editor (Factory default settings are shown in bold italicised text)

Maintenance, Spares, Repair and Servicing



Section	Parameter as shown on display	Factory Settings
Display	Contrast	53%
	Language	English
	Page timer	5m
	Scroll timer	2s

7 MAINTENANCE, SPARES, REPAIR AND SERVICING

The DSE8600 Series controller is designed to be *Fit and Forget*. As such, there are no user serviceable parts within the controller.

In the case of malfunction, you should contact your original equipment supplier (OEM).

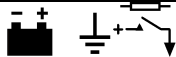
7.1.1.1 INDIVIDUAL PLUGS

8600 series terminal designation	Plug description	Part No.
1-13 	13 way 5.08 mm	007-166
22-38 MSC1 ↑ ↓ MSC2	17 way 5.08 mm	007-452
39-46 ↑ ↓ V1	8 way 7.62 mm	007-454
47-50 V2	4 way 7.62 mm	007-171
60-70 	11 way 5.08 mm	007-451
RS485	3 way 5.08 mm	007-174
	PC Configuration interface lead (USB type A – type B)	016-125

7.2 PURCHASING ADDITIONAL FIXING CLIPS FROM DSE

Item	Description	Part No.
	8600 series fixing clips (packet of 4)	020-294



7.3 PURCHASING ADDITIONAL SEALING GASKET FROM DSE

Item	Description	Part No.
	8600 series silicon sealing gasket	020-507

7.4 EXPANSION MODULES

NOTE:- A maximum of twenty (20) expansion modules can be connected to the DSEnet®.

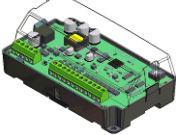
NOTE:- DSEnet® utilises an RS485 connection. Using Belden 9841 (or equivalent) cable allows for the expansion cable to be extended to a maximum of 1.2 km.
DSE Stock and supply Belden 9841 cable. DSE Part Number 016-030.

Item	Max No. supported	Description	Model order number	DSE Part numbers		
				Sales literature	Operator manual	Installation Instructions
	4	Model DSE2130 expansion input module provides additional analogue and digital inputs for use with the 73x0 controller	2130-001-00	055-060	057-082	053-033
	10	Model DSE2157 expansion relay module provides eight additional voltage free relays for use with the 73x0 controller	2157-001-00	055-061	057-083	053-034
	10	Model DSE2548 expansion LED module provides additional LED indications, internal sounder and remote lamp test/alarm mute for use with the 73x0 controller.	2548-001-00	055-062	057-084	053-032

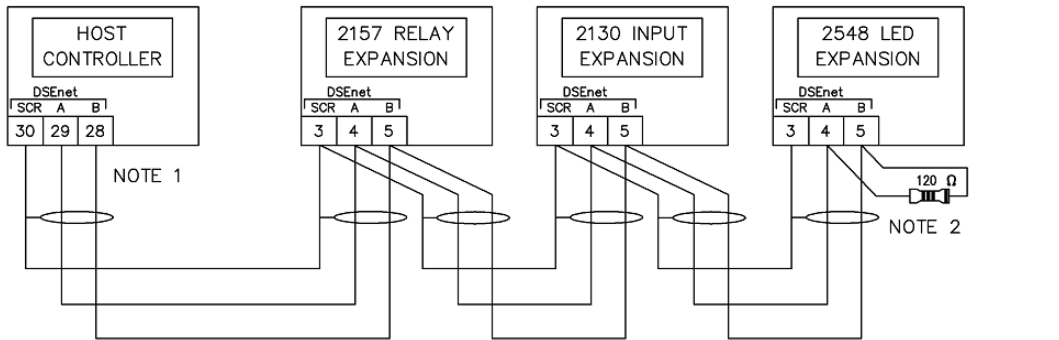

NOTE 1
AS A TERMINATING RESISTOR IS INTERNALLY FITTED TO THE HOST CONTROLLER, THE HOST CONTROLLER MUST BE THE FIRST UNIT ON THE DSEnet

NOTE 2
A 120 OHM TERMINATION RESISTOR MUST BE FITTED TO THE LAST UNIT ON THE DSEnet

8 WARRANTY

DSE provides limited warranty to the equipment purchaser at the point of sale. For full details of any applicable warranty, you are referred to your original equipment supplier (OEM).

9 DISPOSAL

9.1 WEEE (WASTE ELECTRICAL AND ELECTRONIC EQUIPMENT)

Directive 2002/96/EC

If you use electrical and electronic equipment you must store, collect, treat, recycle and dispose of WEEE separately from your other waste.



9.2 ROHS (RESTRICTION OF HAZARDOUS SUBSTANCES)

Directive 2002/95/EC:2006

To remove specified hazardous substances (Lead, Mercury, Hexavalent Chromium, Cadmium, PBB & PBDE's)

Exemption Note: Category 9. (Monitoring & Control Instruments) as defined in Annex 1B of the WEEE directive will be exempt from the RoHS legislation. This was confirmed in the August 2005 UK's Department of Trade and Industry RoHS REGULATIONS Guide (Para 11).

Despite this exemption, DSE has been carefully removing all non RoHS compliant components from our supply chain and products.

When this is completed a Lead Free & RoHS compatible manufacturing process will be phased into DSE production.

This is a process that is almost complete and is being phased through different product groups.